



Semester- II

MSc-IT
Paper: INF 2016

Data Communication and Computer Networks

www.idolgu.in

GAUHATI UNIVERSITY
Institute of Distance and Open Learning

M.Sc.-IT-19-II-2016

Second Semester

(under CBCS)

M.Sc.-IT

Paper: INF-2016

**DATA COMMUNICATION
AND COMPUTER NETWORKS**



Contents:

**BLOCK I: BASICS OF COMPUTER NETWORKS AND DATA
COMMUNICATION**

- Unit 1 : Evolution of Computer Networks
- Unit 2 : Types of Computer Networks
- Unit 3 : Network Standards
- Unit 4 : The Physical Layer: Introduction to Data Communication
- Unit 5 : The Physical Layer: Transmission Media
- Unit 6 : The Physical Layer: Transmission Modes

BLOCK II: THE DATA LINK LAYER, LAN, WIRELESS LAN

- Unit 1 : The Data Link Layer: Design Issues
- Unit 2 : The Data Link Layer: The Protocols
- Unit 3 : The MAC Sub Layer
- Unit 4 : The Local Area Network (LAN)
- Unit 5 : The Wireless LAN

**BLOCK III: THE NETWORK, TRANSPORT AND APPLICATION
LAYERS**

- Unit 1 : The Network Layer: Design Issues
- Unit 2 : The Network Layer: Routing
- Unit 3 : The Network Layer: The Internet
- Unit 4 : The Transport Layer: The Services
- Unit 5 : The Transport Layer: The Protocols
- Unit 6 : The Application Layer
- Unit 7 : Network Management and Security

Contributors:

Mr. Bhaskarjyoti Choudhury (Block I : Unit- 1)

Asstt. Prof., Dept. of Computer Applications
Rangia College, Rangia, Assam

Dr. Kshirod Sarmah (Block I: Unit- 2)

Asstt. Prof., Dept. of Computer Science
PDUAM, Goalpara, Assam

Dr. Vaskar Deka (Block I : Unit- 3)

Asstt. Prof., Dept. of IT
Gauhati University, Assam

Mr. Nayan Mahanta (Block I : Unit- 4, Block II: Unit 3)

Asstt. Prof., Dept. of Computer Science
Pragiyotish College, Guwahati, Assam

Mr. Ainul Matin Choudhury (Block I: Units- 5 & 6)

Asstt. Prof., Dept. of Computer Science
Pragiyotish College, Guwahati, Assam

Dr. Satyajit Sarma (Block II: Units- 1 & 2)

Asstt. Prof., Dept. of IT
Gauhati University, Assam

Dr. Fakharuddin Ahmed (Block II : Unit- 4)

Asstt. Prof., Dept. of IT
LCB College, Guwahati, Assam

Mrs. Manisha Deka (Block II: Unit- 5, Block III: Unit- 4)

Asstt. Prof., Dept. of Computer Science
LCB College, Guwahati, Assam

Mr. Mridul Suklabaidya (Block III: Unit- 1)

Teaching Associate, Dept. of Computer Science
Gauhati University, Assam

Mr. Rahul Lahkar (Block III: Unit- 2)

Asstt. Prof., Dept. of Computer Science
Pub Kamrup College, Assam

Dr. Aniruddha Deka (Block III: Unit- 3)

Asstt. Prof., Dept. of Computer Science and Engineering
Royal Global University, Guwahati, Assam

Mr. Subrat Chetia (Block III: Unit- 5)

Asstt. Prof., Dept. of Computer Science
PDUAM, Dalgaon, Assam

Mrs. Arunima Devi (Block III: Units- 6 & 7)

Asstt. Prof., Dept. of Computer Science
NERIM, Guwahati, Assam

Content Editor:

Dr. Gautam Chakrabarty

Asstt. Prof.(Senior), School of Computer Science, NERIM, Guwahati

Course Coordination:

Prof. Dandadhar Sarma Director, IDOL, Gauhati University

Prof. Anjana Kakoti Mahanta Prof., Dept. Computer Science, G.U.

Cover Page Designing:

Bhaskar Jyoti Goswami IDOL, Gauhati University

May, 2022

© Copyright by IDOL, Gauhati University. All rights reserved. No part of this work may be reproduced, stored in a retrieval system, or transmitted, in any form or by any means, electronic, mechanical, photocopying, or otherwise.
Published on behalf of Institute of Distance and Open Learning, Gauhati University by the Director, and printed at Gauhati University Press, Guwahati-781014.

BLOCK I:
BASICS OF COMPUTER NETWORKS
AND DATA COMMUNICATION

UNIT 1: EVOLUTION OF COMPUTER NETWORKS

Space for learners

Unit Structure:

- 1.1 Introduction
- 1.2 Unit Objectives
- 1.3 Basic terms and their Definitions
- 1.4 Circuit switching
- 1.5 Packet switching
- 1.6 Development of Packet switching: 1961-72
- 1.7 Proprietary Networks
- 1.8 Proprietary Networks and Internetworking: 1972-1980
- 1.9 Proliferation of Networks: 1980-1990
- 1.10 Explosion 1990s
- 1.11 Summing Up
- 1.12 Answers to Check Your Progress
- 1.13 Possible Questions
- 1.14 References and Suggested Readings

1.1 INTRODUCTION

In this unit, the fundamental aspects pertaining the computer networks will be discussed. Various types of computer networks such as LAN, MAN and WAN and how they are created and configured are also described. Further, the phases of development of computer networks are considered here. The concept of circuit switching and packet switching and their development are also to be covered in this unit.

1.2 OBJECTIVES:

After going through this unit, you will be able to:

- Understand the evolutions of computer networks.
- Know different types of computer networks and why they are categorized.

- Understand circuit switching and packet switching.
- Learn how internetworking of computers is done.
-

1.3 BASIC TERMS AND THEIR DEFINITIONS:

A computernetwork is a group of computers linked to each other that enables the computer to communicate with another computer and share their resources, data and applications.

The computer networks covered in this unit are obviously not the only type of networks created throughout human civilization. Possibly the oldest example of network covering large territories and serving multiple clients is the water supply system of ancient Rome.

Topology: Network topology is a physical layout of the computer network and it defines how the computers, devices, cables, etc. are connected to each other.

Router: The router is a network device that connects two or more network segments. It is used to transfer information from the source to the destination.

Server:A server is a computer program or device that provides a service to another computer program and its user, also known as the client. In a data center, the physical computer that a server program runs on is also frequently referred to as a server. That machine might be a dedicated server or it might be used for other purposes.A server is a computer program or device that provides a service to another computer program and its user, also known as the client. In a data center, the physical computer that a server program runs on is also frequently referred to as a server. That machine might be a dedicated server or it might be used for other purposes.

LAN: The full form of LAN is local area network is a computer networks that connects a relatively small area. Most LANs are confined to a single buildingor group of buildings. LANs are capable of transmitting data at very fast rates and there is also a limit on the number of computers that can be attached to asingle LAN. A local area network is a group of computers to a server using a shared common communications line or wireless link.

Space for learners

MAN: A metropolitan area network (MAN) that interconnects users with computer resources in a geographic area or region larger than local area network but smaller than WAN. It is also used to mean the interconnection of several local area networks by bridging them with backbone lines.

The working mechanism of MAN is similar to an Internet Service Provider, but a MAN is not owned by a single organization. Like a WAN, a MAN provides shared network connections to its users.

WAN: A wide area network is a network that covers a board area using leased telecommunication lines. WANs often connect multiple smaller networks, such as local area network or metropolitan area network. The internet can be considered as well, and is used by businesses, governments, organizations and individuals for almost any propose imaginable.

Switch: A network switch is networking hardware that connects devices on a computer network by using packet switching to receive and forward data to the destination device. A network switch is a multiport network bridge that uses MAC addresses to forward data at the data link layer of the OSI model.

1.4 CIRCUIT SWITCHING

Circuit switching is a method of implementing a telecommunication network in which two or more network nodes establish a dedicated communications channel (circuit) through the network before the nodes may communicate. It is presented in Figure 1. The circuit guarantees the full bandwidth of the channel and remains connected for the duration of the communication session.

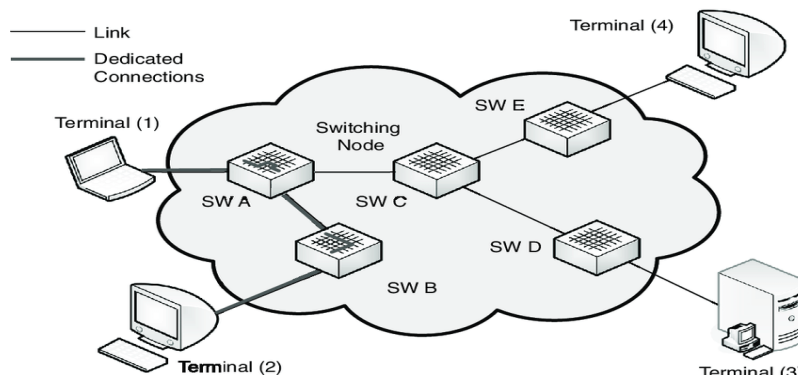

Figure 1. Circuit Switching network

The circuit functions as if the nodes were physically connected as with an electrical circuit. Circuit switching was originated in analog telephone networks where the network created a dedicated circuit between two telephones for the duration of a telephone call. It contrasts with message switching and packet switching used in modern digital networks in which the trunk lines between switching centers carry data between many different nodes in the form of data packets without dedicated circuits.

1.5 PACKETSWITCHING

In telecommunications, packet switching is a method of grouping data that is transmitted over a digital network into *packets*. Packets are made of a header and a payload. Data in the header is used by networking hardware to direct the packet to its destination, where the payload is extracted and used by application software. Packet switching is the primary basis for data communications in computer networks worldwide. Figure 2 presents an architecture of packet switching.

In the early 1960s, American computer scientist Paul Baran developed the concept *Distributed Adaptive Message Block Switching*, with the goal of providing a fault-tolerant, efficient routing method for telecommunication messages as part of a research program at the RAND Corporation, funded by the US Department of Defense. This concept contradicted then-established principles of pre-allocation of network bandwidth, exemplified by the development of telecommunications in the Bell System. The new concept found little resonance among network implementers until the independent work of Welsh computer scientist Donald Davies at the National Physical Laboratory (United Kingdom) in 1965. Davies is credited with coining the modern term *packet switching* and inspiring numerous packet switching networks in the decade following, including the incorporation of the concept into the design of the ARPANET in the United States.

Space for learners

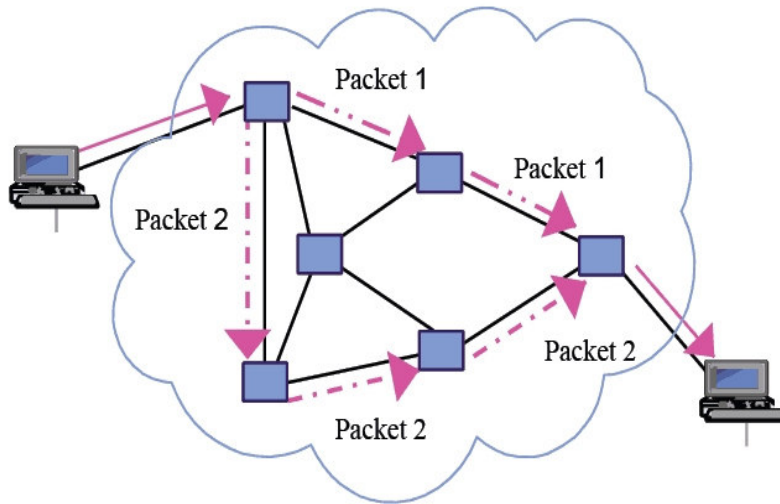

Figure 2. Packet switching Network

1.6 DEVELOPMENT OF PACKET SWITCHING: 1961-1972

The field of computer networking and today's Internet trace their beginnings back to the early 1960s, a time at which the telephone network was the world's dominant communication network. Then the telephone network used circuit switching to transmit information from a sender to receiver – an appropriate choice given that voice is transmitted at a constant rate between sender and receiver. Given the increasing importance (and great expense) of computers in the early 1960's and the advent of timeshared computers, it was perhaps natural to consider the question of how to hook computers together so that they could be shared among geographically distributed users. The traffic generated by such users was likely to be "bursty" – intervals of activity, e.g., the sending of a command to a remote computer, followed by periods of inactivity, while waiting for a reply or while contemplating the received response.

Three research groups around the world, all unaware of the others' work [Leiner 98], began inventing the notion of packet switching as an efficient and robust alternative to circuit switching. The first

published work on packet-switching techniques was the work by Leonard Kleinrock [Kleinrock 1961, Kleinrock 1964], at that time a graduate student at MIT. Using queuing theory, Kleinrock's work elegantly demonstrated the effectiveness of the packet-switching approach for bursty traffic sources. At the same time, Paul Baran at the Rand Institute had begun investigating the use of packet switching for secure voice over military networks [Baran 1964], while at the National Physical Laboratory in England, Donald Davies and Roger Scantlebury were also developing their ideas on packet switching.

The work at MIT, Rand, and NPL laid the foundations for today's Internet. But the Internet also has a long history of a Let's build it and demonstrate it attitude that also dates back to the early 1960's. J.C.R. Licklider [DEC 1990] and Lawrence Roberts, both colleagues of Kleinrock's at MIT, both went on to lead the computer science program at the Advanced Projects Research Agency (ARPA) in the United States. Roberts [Roberts 67] published an overall plan for the so-called ARPAnet [Roberts 1967], the first packet-switched computer network and a direct ancestor of today's public Internet. The early packet switches were known as Interface Message Processors (IMP's) and the contract to build these switches was awarded to BBN. On Labor Day in 1969, the first IMP was installed at UCLA, with three additional IMP being installed shortly thereafter at the Stanford Research Institute, UC Santa Barbara, and the University of Utah. The fledgling precursor to the Internet was four nodes large by the end of 1969. Kleinrock recalls the very first use of the network to perform a remote login from UCLA to SRI crashing the system

By 1972, ARPAnet had grown to approximately 15 nodes, and was given its first public demonstration by Robert Kahn at the 1972 International Conference on Computer Communications. The first host-to-host protocol between ARPAnet end systems known as the Network Control Protocol (NCP) was completed [RFC 001]. With an end-to-end protocol available, applications could now be written. The first e-mail program was written by Ray Tomlinson at BBN in 1972.

Space for learners

1.7 PROPRIETARY NETWORKS:

A network of automated teller machines (ATMs) are available for use only by the customers of a specific bank or financial institution or some other limited group. Proprietary networks have been succeeded by ATM networks that allow the customers of a bank to use free of charge the withdrawal facilities of several other banks with which it has entered a reciprocal agreement.

1.8 PROPRIETARY NETWORKS AND INTERNET WORKING: 1972-1980

The initial ARPAnet was a single, closed network. In order to communicate with an ARPAnet host, one had to actually be attached to another ARPAnet IMP. In the early to mid 1970's, additional packet-switching networks besides ARPAnet came into being; ALOHA net, a satellite network linking together universities on the Hawaiian Islands [Abramson 1972]; Telenet, a BBN commercial packet-switching network based on ARPAnet technology; Tymnet; and Transpac, a French packet-switching network. The number of networks was beginning to grow. In 1973, Robert Metcalfe's PhD thesis laid out the principle of Ethernet, which would later lead to a huge growth in so-called Local Area Networks (LANs) that operated over a small distance based on the Ethernet protocol.

Once again, with perfect hindsight one might now see that the time was ripe for developing an architecture for connecting networks together. Pioneering work on interconnecting networks (once again under the sponsorship of DARPA), in essence creating a *network of networks*, was done by Vinton Cerf and Robert Kahn [Cerf 1974]; the term "internetting" was coined to describe this work. The architectural principles that Kahn articulated for creating a so-called "open network architecture" are the foundation on which today's Internet is built [Leiner 98]:

- **minimalism, autonomy:** a network should be able to operate on its own, with no internal changes required for it to be internetworked with other networks;
- **best effort service:** internetworked networks would provide best effort, end-to-end service. If reliable communication

Space for learners

was required, this could be accomplished by retransmitting lost messages from the sending host;

- **stateless routers:** the routers in the internetworked networks would not maintain any per-flow state about any ongoing connection.
- **decentralized control:** there would be no global control over the internetworked networks.

These principles continue to serve as the architectural foundation for today's Internet, even 25 years later – a testament to insight of the early Internet designers.

These architectural principles were embodied in the TCP protocol. The early versions of TCP, however, were quite different from today's TCP. The early versions of TCP combined a reliable in-sequence delivery of data via end system retransmission with forwarding functions (which today are performed by IP). Early experimentation with TCP, combined with the recognition of the importance of an unreliable, non-flow-controlled end-to-end transport service for application such as packetized voice, led to the separation of IP out of TCP and the development of the UDP protocol. The three key Internet protocols that we see today – TCP, UDP and IP – were conceptually in place by the end of the 1970's.

In addition to the DARPA Internet-related research, many other important networking activities were underway. In Hawaii, Norman Abramson was developing ALOHA net, a packet-based radio

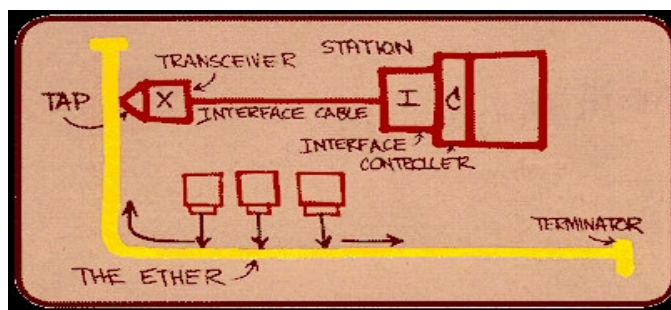

Figure 3. A 1976 drawing by R. Metcalfe of the Ethernet concept (from Charles Spurgeon's Ethernet Web Site)

network that allowed multiple remote sites on the Hawaiian Islands to communicate with each other. The ALOHA protocol [Abramson 1970] was the first so-called multiple access protocol, allowing geographically distributed users to share a single broadcast communication medium (a radio frequency). Abramson's work on multiple access protocols was built upon by Robert Metcalfe in the development of the Ethernet protocol [Metcalfe 1976] for wire-based shared broadcast networks. Interestingly, Metcalfe's Ethernet protocol was motivated by the need to connect multiple PCs, printers, and shared disks together [Perkins 1994]. Twenty-five years ago, well before the PC revolution and the explosion of networks, Metcalfe and his colleagues were laying the foundation for today's PC LANs. Ethernet technology represented an important step for internetworking as well. Each Ethernet local area network was itself a network, and as the number of LANs proliferated, the need to internetwork these LANs together became all the more important. An excellent source for information on Ethernet is Spurgeon's Ethernet Web Site, which includes Metcalfe's drawing of his Ethernet concept, as shown below in Figure 3. We discuss Ethernet, Aloha, and other LAN technologies in detail.

In addition to the DARPA internetworking efforts and the Aloha/Ethernet multiple access networks, a number of companies were developing their own proprietary network architectures. Digital Equipment Corporation (DEC) released the first version of the DECnet in 1975, allowing two PDP-11 minicomputers to communicate with each other. DECnet has continued to evolve since then, with significant portions of the OSI protocol suite being based on ideas pioneered in DECnet. Other important players during the 1970's were Xerox (with the XNS architecture) and IBM (with the SNA architecture). Each of these early networking efforts would contribute to the knowledge base that would drive networking in the 80's and 90's.

It is also worth noting here that in the 1980's (and even before), researchers [Fraser 1983, Turner 1986, Fraser 1993] were also developing a "competitor" technology to the Internet architecture. These efforts have contributed to the development of the ATM (Asynchronous Transfer Mode) architecture, a connection-oriented approach based on the use of fixed size packets, known as cells.

1.9 PROLIFERATION OF NETWORKS:1980-1990

By the end of the 1970's, approximately 200 hosts were connected to the ARPAnet. By the end of the 1980's, the number of host connected to the public Internet, a confederation of networks looking much like today's Internet would reach 100,000. The 1980's would be a time of tremendous growth.

Much of the growth in the early 1980's resulted from several distinct efforts to create computer networks linking universities together. BITnet (Because It's ThereNETwork) provided email and file transfers among several universities in the Northeast. CSNET (Computer Science NETwork) was formed to link together university researchers without access toARPAnet. In 1986, NSFNET was created to provide access to NSF-sponsored supercomputing centers. Starting with an initial backbone speed of 56 Kbps, NSFNET's backbone would be running at 1.5 Mbps by the end of the decade, and would be serving as a primary backbone linking together regional networks.

In the ARPAnet community, many of the final pieces of today's Internet architecture were falling into place. January 1, 1983 saw the official deployment of TCP/IP as the new standard host protocol for ARPA net (replacing the NCP protocol). The transition [Postel 1981] from NCP to TCP/IP was a "flag day" type event – all hosts were required to transfer over to TCP/IP as of that day. In the late 1980's, important extensions were made to TCP to implement host-based congestion control [Jacobson 1988]. The Domain Name System, used to map between a human-readable Internet name (e.g., gaia.cs.umass.edu) and its 32-bit IP address, was also developed [Mockapetris 1983, Mockapetris 1987].

Paralleling this development of the ARPAnet (which was for the most part a US effort), in the early 1980s the French launched the Minitel project, an ambitious plan to bring data networking into everyone's home. Sponsored by the French government, the Minitel system consisted of a public packet-switched network (based on the X.25 protocol suite, which uses virtual circuits), Minitel servers, and inexpensive terminals with built-in low speed modems. The Minitel became a huge success in 1984 when the French government gave away a free Minitel terminal to each French household that wanted

Space for learners

one. Minitel sites included free sites – such as a telephone directory site – as well as private sites, which collected a usage-based fee from each user. At its peak in the mid 1990s, it offered more than 20,000 different services, ranging from home banking to specialized research databases. It was used by over 20% of France's population, generated more than \$1 billion each year, and created 10,000 jobs. The Minitel was in a large fraction of French homes ten years before most Americans had ever heard of the Internet. It still enjoys widespread use in France, but is increasingly facing stiff competition from the Internet.

Space for learners

1.10 EXPLOSION 1990S:

The 1990's were issued in with two events that symbolized the continued evolution and the soon-to-arrive commercialization of the Internet. First, ARPAnet, the forebear of the Internet ceased to exist. MILNET and the Defense Data Network had grown in the 1980's to carry most of the US Department of Defense related traffic and NSFNET had begun to serve as a backbone network connecting regional networks in the United States and national networks overseas. Also, in 1990, The World (<http://gaia.cs.umass.edu/kurose/introduction/www.world.std.com>) became the first public dialup Internet Service Provider (ISP). In 1991, NSFNET lifted its restrictions on use of NSFNET for commercial purposes. NSFNET itself would be decommissioned in 1995, with Internet backbone traffic being carried by commercial Internet Service Providers.

The main event of the 1990's however, was to be the release of the World Wide Web, which brought the Internet into the homes and businesses of millions and millions of people, worldwide. The Web also served as a platform for enabling and deploying hundreds of new applications, including on-line stock trading and banking, streamed multimedia services, and information retrieval services.

The WWW was invented at CERN by Tim Berners-Lee in 1989–1991 [Berners-Lee 1989], based on ideas originating in earlier work on hypertext from the 1940's by Bush [Bush 1945] and since the 1960's by Ted Nelson [Ziff-Davis 1998]. Berners-Lee and his associates developed initial versions of HTML, HTTP, a Web server

and a browser – the four key components of the WWW. The original CERN browsers only provided a line-mode interface. Around the end of 1992, there were about 200 Web servers in operation, this collection of servers being the tip of the iceberg for what was about to come. At about this time, several researchers were developing Web browsers with GUI interfaces, including Marc Andreessen, who developed the popular GUI browser Mosaic for X. He released an alpha version of his browser in 1993, and in 1994 formed Mosaic Communications, which later became Netscape Communications Corporation. By 1995, university students were using Mosaic and Netscape browsers to surf the Web on a daily basis. During this period, the US Government began to transfer the control of the Internet backbone to private carriers. Companies – big and small – began to operate Web servers and transact commerce over the Web. In 1996, Microsoft got into the Web business in a big way, and in the late 1990s it was used for making its browser a central component of its operating system. In 1999, there were over two-million Web servers in operation. And all of this happened in less than ten years.

During the 1990's, networking research and development also made significant advances in the areas of high-speed routers and routing and local area networks. The technical community struggled with the problems of defining and implementing an Internet service model for traffic requiring real-time constraints, such as continuous media applications. The need to secure and manage Internet infrastructure also became of paramount importance as e-commerce applications proliferated and the Internet became a central component of the world's telecommunications infrastructure.

Space for learners

CHECK YOUR PROGRESS

1. The _____ is a network device that connects two or more network segments.
2. The full form of LAN is _____.
3. In _____, a dedicated path is established before the communication between the nodes.
4. _____ is a method of grouping data that is transmitted over a digital network into *packets*.

1.11 SUMMING UP

This unit describes the basic terms and definitions of the components of computer networks. Different types of computer networks are also describe in this unit. This unit also describes the working of circuit switching, packet switching techniques for data transmissions and Proprietary Networks and Internetworking.

1.12 ANSWERS TO CHECK YOUR PROGRESS

1. router.
2. local area network
3. Circuit switching
4. Packet switching

1.13 POSSIBLE QUESTIONS

- 1) What is Computer Network? What are its different types?
- 2) Is there any difference between Internet and Intranet?
- 3) LAN is bigger than MAN- is it true?
- 4) Explain impact of Internet on our society.
- 5) Explain difference between circuit and packet switching.
- 6) Explain proprietary networks and internetworking in the era of 1972-80.
- 7) Explain the explosion of Internet in 1990s.

1.14 REFERENCES AND SUGGESTED READINGS

- **[Abramson 1970]** N. Abramson, The Aloha System – Another Alternative for Computer Communications, Proceedings of Fall Joint Computer Conference, AFIPS Conference, 1970, p. 37.
- **[Baran 1964]** P. Baran, On Distributed Communication Networks, *IEEE Transactions on Communication Systems*, March, 1964. Rand Corporation Technical report with the same title (Memorandum RM-3420-PR, 1964).
- **[Berners-Lee 1989]** Tim Berners-Lee, CERN, Information Management: A Proposal, March 1989, May 1990

Space for learners

- **[Bush 1945]** V. Bush, As We May Think, The Atlantic Monthly, July 1945.
- **[Cerf 1974]** V. Cerf and R. Kahn, A protocol for packet network interconnection, *IEEE Transactions on Communications Technology*, Vol. COM-22, Number 5 (May 1974), pp. 627–641.
- **[DEC 1990]** Digital Equipment Corporation, In Memoriam: J.C.R. Licklider 1915–1990, SRC Research Report 61, August 1990.
- **[Hobbes 1998]** R. Hobbes Zakon, Hobbes Internet Timeline, Version 3.3, 1998.
- **[Fraser 1983]** Fraser, A. G. (1983). Towards a universal data transport system. *IEEE Journal on Selected Areas in Communications*, SAC-1(5):803–816.
- **[Fraser 1993]** Fraser, A. G. (1993). Early experiments with asynchronous time division networks. *IEEE Network Magazine*, 7(1):12–27.
- **[Jacobson 1988]** V. Jacobson, Congestion Avoidance and Control, *Proc. ACM Sigcomm 1988 Conference*, in Computer Communication Review, vol. 18, no. 4, pp. 314–329, Aug. 1988
- **[Kleinrock 1961]** L. Kleinrock, Information Flow in Large Communication Networks, RLE Quarterly Progress Report, July 1961.
- **[Kleinrock 1964]** L. Kleinrock, 1964 Communication Nets: Stochastic Message Flow and Delay, McGraw-Hill 1964, later re-issued by Dover Books.
- **[Kleinrock 1998]** L. Kleinrock, The Birth of the Internet, <http://millenium.cs.ucla.edu/LK/Inet/birth.html>.
- **[Leiner 98]** B. Leiner, V. Cerf, D. Clark, R. Kahn, L. Kleinrock, D. Lynch, J. Postel, L. Roberts, S. Woolf, A Brief History of the Internet, <http://www.isoc.org/internet/history/brief.html>
- **[Metcalf 1976]** Robert M. Metcalfe and David R. Boggs. Ethernet: Distributed Packet Switching for Local Computer Networks, *Communications of the Association for Computing Machinery*, Vol 19/No 7, July 1976.

- **[Mockapetris 1983]** P.V. Mockapetris, Domain names: Implementation specification, RFC 833, Nov-01-1983.
- **[Mockapetris 1987]** P.V. Mockapetris, Domain names – concepts and facilities, RFC 1034, Nov-01-1987.
- **[Perkins 1994]** A. Perkins, Networking with Bob Metcalfe, The Red Herring Magazine, November 1994.
- **[Postel 1981]** J. Postel, NCP/TCP Transition Plan, RFC 7801, November 1981.
- **[RFC 001]** S. Crocker, Host Software, RFC 001 (the *very first* RFC!).
- **[Roberts 1967]** L. Roberts, T. Merrill Toward a Cooperative Network of Time-Shared Computers, Fall AFIPS Conference, Oct. 1966.
- **[Turner 1986]** J. Turner, New Directions in Communications (or Which Way to the Information Age?), *Proceedings of the Zurich Seminar on Digital Communication*, pp. 25–32, 3/86.
- **[W3C 1995]** The World Wide Web Consortium, A Little History of the World Wide Web, 1995.
- **[Ziff-Davis 1998]** Ziff-Davis Publishing, "Ted Nelson: hypertext pioneer,"

Space for learners

UNIT 2: TYPES OF COMPUTER NETWORKS

Space for learners

Unit Structure:

- 2.1 Introduction
- 2.2 Unit Objectives
- 2.3 Applications and Uses of Computer Networks
- 2.4 Types of Computer Networks
 - 2.4.1 Computer Networks based on Transmission Technology
 - 2.4.2 Computer Networks based on size of area covered
- 2.5 Types of Network based on capacity of computers connected
 - 2.5.1 Peer-to-peer Networks
 - 2.5.2 Server – based Networks
- 2.6 Computer Networks based on connection set-up.
 - 2.6.1 Connection Oriented Networks
 - 2.6.2 Connection-less Networks
 - 2.6.3 Difference between Connection oriented and Connectionless networks
- 2.7 Wireless Networks
 - 2.7.1 Wireless Network Components
 - 2.7.2 System Interconnection
 - 2.7.3 Wireless LANs
 - 2.7.4 Wireless WANs
- 2.8 Network Topology
 - 2.8.1 Mesh Topology
 - 2.8.2 Star Topology
 - 2.8.3 Bus Topology
 - 2.8.4 Ring Topology
 - 2.8.5 Hybrid Topology
- 2.9 Internetwork
- 2.10 Summing up
- 2.11 Answers to Check Your Progress
- 2.11 Possible Questions
- 2.12 References and Suggested Readings

2.1 INTRODUCTION

A network is any collection of independent computers that communicate with one another over a shared network medium. A computer network is a collection of two or more connected computers. When these computers are joined in a network, people can share files and peripherals such as modems, printers, tape backup drives, or CD-ROM drives. When networks at multiple locations are connected using services available from phone companies, people can send e-mail, share links to the global Internet, or conduct video conferences in real time with other remote users.

According to **Tenenbaum**, a network can be defined as an interconnected collection of autonomous computers. Two computers are said to be interconnected if they are capable of exchanging information. Central to this definition is the fact that the computers are autonomous. This means that no computer on the network can start, stop, or control another.

Every network includes following four basic components:

- At least two computers: Server or Client workstation for sharing data and information.
- Networking Interface Card's (NIC) or Ethernet Card.
- A connection medium, usually a wire or cable, although wireless communication between networked computers and peripherals is also possible.
- Network Operating system software, such as Microsoft Windows NT or 2000, Novell NetWare, Unix and Linux to make possible communication among computers.

Above all, a data communications system or computer network system has following five parts to fulfil a successful networking system.

- **Message or information or data**

The message is the information (data) to be communicated. Popular forms of information include text, numbers, pictures, audio, and video.

- **Sender**

Space for learners

The sender is the device that sends the data message. It can be a computer, workstation, telephone handset, video camera, and so on.

- **Receiver.**

The receiver is the device that receives the message. It can be a computer, workstation, telephone handset, television, and so on.

- **Transmission medium**

The transmission medium refers to the physical path by which a message travels from sender to receiver. Some examples of transmission media include twisted-pair wire, coaxial cable, fiber-optic cable, and radio waves.

- **Protocol.**

A protocol is a set of rules that govern data communications. It represents an agreement between the communicating devices. Without a protocol, two devices may be connected but cannot communicate, just as a person speaking French cannot be understood by a person who speaks only Japanese.

2.2 UNIT OBJECTIVES

After going through this unit, you will be able to:

- Understand the basic concepts of computer networks and its applications.
- Know about the different categories of computer networks.
- Know about the wireless networks and how it works.
- Get the basic concept of networks topologies and its different types.
- Understand about internetworks.

2.3 APPLICATIONS AND USES OF COMPUTER NETWORKS

Data communication networks have become an indispensable part of business, industry, and entertainment. Some of the network applications in different fields are noted in the following:

- **Marketing and sales.** Computer networks are used extensively in both marketing and sales organizations. Marketing professionals use them to collect, exchange, and analyze data relating to customer needs and product development cycles. Sales applications include teleshopping,

which uses order entry computers or telephones connected to an order-processing network, and on-line reservation services for hotels, airlines, and so on.

- **Financial services.** Today's financial services are totally dependent on computer networks. Applications include credit history searches, foreign exchange and investment services, and electronic funds transfer (EFT) which allows a user, to transfer money without going into a bank (an automated teller machine is a kind of electronic funds transfer; automatic paycheck deposit is another).
- **Manufacturing.** Computer networks are used today in, many aspects of manufacturing, including the manufacturing process itself. Two applications that use networks to provide essential services are computer-assisted design (CAD) and computer-assisted manufacturing (CAM), both of which allow multiple users to work on a project simultaneously.
- **Electronic messaging:** Probably the most widely used network application is electronic mail (e-mail).
- **Directory services:** Directory services allow lists of files to be stored in a central location to speed up worldwide search operations.
- **Information services:** Network information services include bulletin boards and data banks. A World Wide Web site offering the technical specifications for a new product is an information service.
- **Electronic data interchange (EDI):** EDI allows business information (including documents such as purchase orders and invoices) to be transferred without using paper.
- **Teleconferencing:** Teleconferencing allows conferences to occur without the participants being in the same place. Applications include simple text conferencing (where participants communicate through their keyboards and computer monitors). voice conferencing (where participants at a number of locations communicate simultaneously over the phone) and video conferencing (where participants can see as well as talk to one another).
- **Cellular telephone:** In the past, two parties were wishing to use the services of the telephone company to be linked by a fixed physical connection. Today's cellular networks make it

Space for learners

possible to maintain wireless phone connections even while traveling over large distances.

- **Cable television:** Future services provided by cable television networks may include video on request, as well as the same information, financial, and communications services currently provided by the telephone companies and computer networks.

2.4 TYPES OF COMPUTER NETWORKS

The computer networks can be of following categories based on different scopes and features.

- (i) Based on Transmission Technology.
- (ii) Based on size of area covered.
- (iii) Based on capacity of computers connected.
- (iv) Based on connection set-up.

2.4.1 Computer Networks based on Transmission Technology

Transmission is actually the process of sending and propagating analog or digital signal of information. Transmission technology generally refers to physical layer protocol activities like modulation, demodulation, line, coding, and many more. It might also include higher-level protocol duties such as digitizing analog signal, data compression, etc.

Computer networks based on transmission media technology are basically divided into two categories: Broadcast Networks and Point-to-Point Networks. These are explained in the following.

2.4.1.1 Broadcast Networks

Broadcast networks are also known as terrestrial networks. It is basically group of radio stations, television stations, or any other electronic media outlets that simply generate agreement to air, or broadcast content generally from centralized source. Broadcasting

Space for learners

is simply method of transferring message to all of the recipients simultaneously.

In this network, message that is sent by node is received by all of other connected nodes to network and share common medium of communication. Broadcast networks also avoid procedures of complex routing of switched network by simply confirming and ensuring that each of transmission of nodes is basically received by all of other nodes in the network. This is the reason why broadcast network has single communications channel.

In this network, each of receiving stations just receives all signals that are sent by transmitters. Even routing of signals is highly affected passively. These networks generally have single communication that is shared by all machines present on network. Short messages also are known as packets that are sent by any of machines present are received by all of the others present over there. Some of the systems of broadcast network also support transmission to subset of machines also known as multicasting. It just links, in contrast, communication channel that is basically shared by all of machines in network.

Advantages of Broadcast Networks –

- In this network, packets are generally transmitted and received by all of computers.
- It allows multicasting in the network.
- It has no limit. Even events can also run as long as required.
- It ensures better utilization of all resources available.

Disadvantages of Broadcast Networks –

- It cannot accommodate huge number of devices.
- It doesn't allow personalization of message.

2.4.1.2 Point-to-Point Networks

Point-to-Point Networks or Point-to-Point Connection is a type of private data connection that is connecting two or more locations securely for private data services. It might also be configured to usually carry voice, internet, and data services together all over same point-to-point network. It simply refers to type of communication connection among two endpoints or nodes of communication. It is the connection among pairs of machines.

Transmission from point-to-point with one sender and receiver is commonly known as unicasting. This network is generally used for two locations that are required to securely send data that is very sensitive and confidential among each of locations. A point-to-point or P2P (Data Link) also gives or provides path from one point that is fixed to other point being fixed. It is very closed network data transport service that does not travel through public Internet. This network includes various connections among individual pairs of machines. A packet present on these types of networks might be required to go through intermediate computers before they reach desired or destination computer. The packets also need to follow multiple routes of different length sizes.

Therefore, routing algorithms are very essential and important in point-to-point connection. This network is generally available in a range of bandwidth speeds along with point-to-point T1, point-to-point Ethernet, or many more.

Advantages of Point-to-Point Networks –

- It increases productivity.
- It generally uses leased lines so that speeds are guaranteed.
- It provides better security so that data can be transferred securely with confidence.

Disadvantages of Point-to-Point Networks –

- With this network, we can only connect two sites.
- It is very expensive for distant locations.

2.4.2 Computer Networks based on size of area covered

Based upon the size, the area it covers and its physical architecture, there are three primary network categories: Local Area Network (LAN), Wide Area Network (WAN) and Metro-Politan Area Network (MAN). Each network differs in their characteristics such as distance, transmission speed, cables and cost. Above all, some other small area covered networks are Personal Area Network (PAN), Storage Area Network (SAN), Campus Area Network (CAN), Passive Optical Local Area Network (POLAN), Enterprise Private Network (EPN), Virtual Private Network (VPN), etc.

2.4.2.1 Local Area Network (LAN)

It is also called LAN and designed for small physical areas such as an office, group of buildings or a factory. LANs are used widely as it is easy to design and to troubleshoot. Personal computers and workstations are connected to each other through LANs. We can use different types of topologies through LAN, which are Star, Ring, Bus, Tree, etc.

LAN can be a simple network like connecting two computers, to share files and network among each other while it can also be as complex as interconnecting an entire building. The block diagram of LAN is presented in figure 2.1.

LAN networks are also widely used to share resources like printers, shared hard-drive etc.

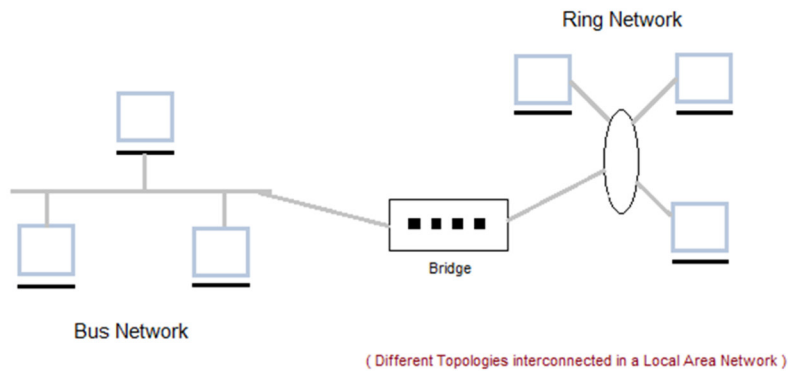

Fig. 2.1 Block Diagram of LAN

Characteristics of LAN

- LANs are private networks, not subject to tariffs or other regulatory controls.
- LANs operate at relatively high speed when compared to the typical WAN.
- There are different types of Media Access Control methods in a LAN, the prominent ones are Ethernet, Token ring.
- It connects computers in a single building, block or campus, i.e. they work in a restricted geographical area.

Applications of LAN

- One of the computers in a network can become a server serving all the remaining computers called clients. Software can be stored on the server and it can be used by the remaining clients.
- Connecting Locally all the workstations in a building to let them communicate with each other locally without any internet access.
- Sharing common resources like printers etc. are some common applications of LAN.

Advantages of LAN

- **Resource Sharing:** Computer resources like printers, modems, DVD-ROM drives and hard disks can be shared with the help of local area networks. This reduces cost and hardware purchases.
- **Software Applications Sharing:** It is cheaper to use same software over network instead of purchasing separate licensed software for each client a network.
- **Easy and Cheap Communication:** Data and messages can easily be transferred over networked computers.
- **Centralized Data:** The data of all network users can be saved on hard disk of the server computer. This will help users to use any workstation in a network to access their data. Because data is not stored on workstations locally.
- **Data Security:** Since, data is stored on server computer centrally, it will be easy to manage data at only one place and the data will be more secure too.
- **Internet Sharing:** LAN provides the facility to share a single internet connection among all the LAN users. In Net Cafes, single internet connection sharing system keeps the internet expenses cheaper.

Space for learners

Disadvantages of LAN

- **High Setup Cost:** Although the LAN will save cost over time due to shared computer resources, but the initial setup costs of installing Local Area Networks is high.
- **Privacy Violations:** The LAN administrator has the rights to check personal data files of each and every LAN user. Moreover, he can check the internet history and computer use history of the LAN user.
- **Data SecurityThreat:** Unauthorised users can access important data of an organization if centralized data repository is not secured properly by the LAN administrator.
- **LAN Maintenance Job:** Local Area Network requires a LAN Administrator because, there may exist various problems in software installations or hardware failures or cable disturbances in Local Area Network which are to be resolved in time.
- **Covers Limited Area:** Local Area Network covers a small area like one office, one building or a group of nearby buildings.

2.4.2.2 Metropolitan Area Network (MAN)

It was developed in 1980s. It is basically a bigger version of LAN. It is also called MAN and uses the similar technology as LAN. It is designed to extend over the entire city. It is meant for connecting a number of LANs into a larger network or it can be a single cable. It is mainly hold and operated by single private company or a public company. The block diagram of MAN is shown in figure 2.2.

Space for learners

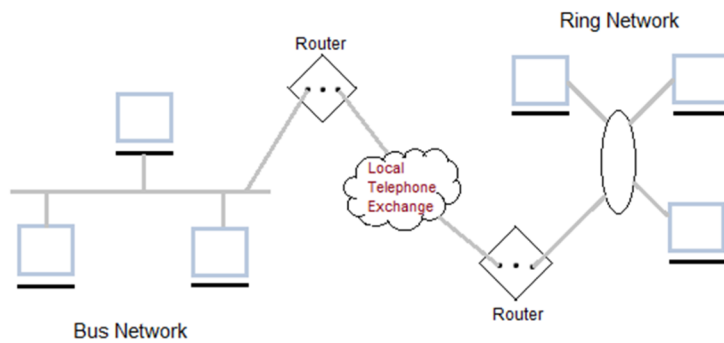

Fig. 2.2 Block Diagram of MAN

Characteristics of MAN

- It generally covers towns and cities (50 km)
- Communication medium used for MAN are optical fibers, cables etc.
- Data rates adequate for distributed computing applications.

Advantages of MAN

- Extremely efficient and provide fast communication via high-speed carriers, such as fibre optic cables.
- It provides a good back bone for large network and provides greater access to WANs.
- The dual bus used in MAN helps the transmission of data in both directions simultaneously.
- A MAN usually encompasses several blocks of a city or an entire city.

Disadvantages of MAN

- More cable is required for a MAN connection from one place to another.
- It is difficult to make the system secure from hackers and industrial espionage(spying) graphical regions.

Space for learners

2.4.2.3 Wide Area Network (WAN)

It is abbreviated as WAN which can be private or public leased network. It is used for the network that covers large distance such as covering states of a country. It is not easy to design and maintain. Communication medium used by WAN are **public switched telephone network (PSTN)** or Satellite links. WAN operates on low data rates which is shown in figure 2.3.

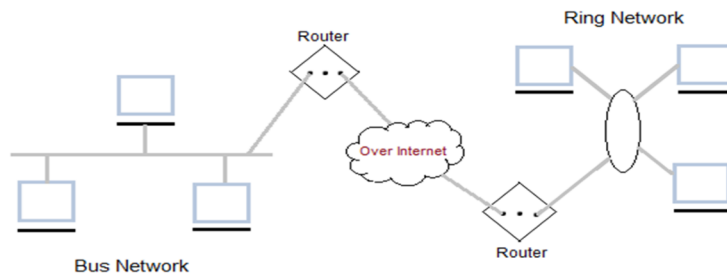

Fig. 2.3 Block Diagram of WAN

Characteristics of WAN

- It generally covers large distances (states, countries, continents).
- Communication medium used are satellite, public telephone networks which are connected by routers.

Advantages of WAN

- Covers a large geographical area and hence, long distance business can connect on the one network.
- Shares software and resources with connecting workstations.
- Messages can be sent very quickly to anyone else on the network. These messages can have picture, sounds or data included with them (called attachments).
- Expensive things (such as printers or phone lines to the internet) can be shared by all the computers on the network.

Space for learners

without having to buy a different peripheral for each computer.

- Everyone on the network can use the same data. This avoids problems where some users may have older information than others.

Disadvantages of WAN

- Need a good firewall to restrict outsiders from entering and disrupting the network.
- Setting up a network can be an expensive, slow and complicated. The bigger the network the more expensive it is.
- Once it is set up, maintaining a network is a full-time job which requires network supervisors and technicians to be employed.
- Security is a real issue when many different people have the ability to use information from other computers. Protection against hackers and viruses adds more complexity and expense.

2.4.2.4 Personal Area Network (PAN)

As a smallest and most basic type of network, a PAN is made up of a wireless modem, a computer or two, phones, printers, tablets, etc., and revolves around one person in one building. These types of networks are typically found in small offices or residences, and are managed by one person or organization from a single device.

2.4.2.5 Campus Area Network (CAN)

Larger than LANs, but smaller than MAN, these types of networks are typically seen in universities, large K-12 school districts or small businesses. They can be spread across several buildings that are fairly close to each other so users can share resources.

2.4.2.6 Storage-Area Network (SAN)

As a dedicated high-speed network that connects shared pools of storage devices to several servers, these types of networks don't rely on a LAN or WAN. Instead, they move storage resources away from

Space for learners

the network and place them into their own high-performance network. SANs can be accessed in the same fashion as a drive attached to a server. Types of storage-area networks include converged, virtual and unified SANs.

2.4.2.7 System-Area Network (SAN)

This term is fairly new within the past two decades. It is used to explain a relatively local network that is designed to provide high-speed connection in server-to-server applications (cluster environments), storage area networks (called “SANs” as well) and processor-to-processor applications. The computers connected on a SAN operate as a single system at very high speeds.

2.4.2.8 Passive Optical Local Area Network (POLAN)

As an alternative to traditional switch-based Ethernet LANs, POLAN technology can be integrated into structured cabling to overcome concerns about supporting traditional Ethernet protocols and network applications such as PoE (Power over Ethernet). A point-to-multipoint LAN architecture, POLAN uses optical splitters to split an optical signal from one strand of singlemode optical fiber into multiple signals to serve users and devices.

2.4.2.9 Enterprise Private Network (EPN)

These types of networks are built and owned by businesses that want to securely connect its various locations to share computer resources.

2.4.2.10 Virtual Private Network (VPN)

By extending a private network across the Internet, a VPN lets its users send and receive data as if their devices were connected to the private network – even if they’re not. Through a virtual point-to-point connection, users can access a private network remotely.

2.5 TYPES OF NETWORKS BASED ON CAPACITY OF COMPUTERS CONNECTED

Computer Networks can be divided in to two main categories based on computer connected

Space for learners

- (i) Peer-to-peer and
- (ii) Server-based.

Space for learners

2.5.1 Peer-to-peer Networks

In peer-to-peer networking, there are no dedicated servers or hierarchy among the computers. All of the computers are equal and therefore known as peers. Normally, each computer serves as Client/Server and there is no one assigned to be an administrator responsible for the entire network. Peer-to-peer networks are good choices for small organizations where the users are allocated in the same general area and security is not an issue.

2.5.2 Server-based Networks

The term Client/server refers to the concept of sharing the work involved in processing data between the client computer and the most powerful server computer. Client/server networks are more suitable for larger networks. A central computer, or 'server', acts as the storage location for files and applications shared on the network. The server also controls the network access of the other computers which are referred to as the 'client' computers. Typically, teachers and students in a school will use the client computers for their work and only the network administrator (usually a designated staff member) will have access rights to the server.

The client/server network is the most efficient way to provide

- Databases and management of applications such as Spreadsheets, Accounting, Communications and Document management.
- Network management.
- Centralized file storage.

The client/server model is basically an implementation of distributed or cooperative processing. At the heart of the model is the concept of splitting application functions between a client and a server processor. The division of labour between the different processors enables the application designer to place an application function on the processor that is most appropriate for that function. This lets the software designer to optimize the use of

processors providing the greatest possible return on investment for the hardware.

Client/server application design also lets the application provider mask the actual location of application function. The user often does not know where a specific operation is executing. The entire function may execute in either the PC or server, or the function may be split between them. This masking of application function locations enables system implementers to upgrade portions of a system over time with a minimum disruption of application operations, while protecting the investment in existing hardware and software.

2.6 COMPUTER NETWORKS BASED ON CONNECTION SET-UP.

There are the two categories of computer networks found based on the connection set-up services. These are:

1. Connection Oriented Networks
2. Connection-less Networks

2.6.1 Connection Oriented Networks

Connection-oriented networks are related to the telephone system. It includes the connection establishment and connection termination. In connection-oriented service, Handshake method is used to establish the connection between sender and receiver.

There is a sequence of operation to be followed by the users of connection-oriented networks. These are:

1. Connection is established.
2. Information is sent.
3. Connection is released.

In connection-oriented networks, we have to establish a connection before starting the communication. When connection is established, we send the message or the information and then we release the connection. Connection oriented service is more reliable than connectionless service. We can send the message in connection-

Space for learners

oriented service if there is an error at the receiver's end. Example of connection oriented is TCP (Transmission Control Protocol) protocol. Figure 2.4 presents the architecture of connection-oriented network.

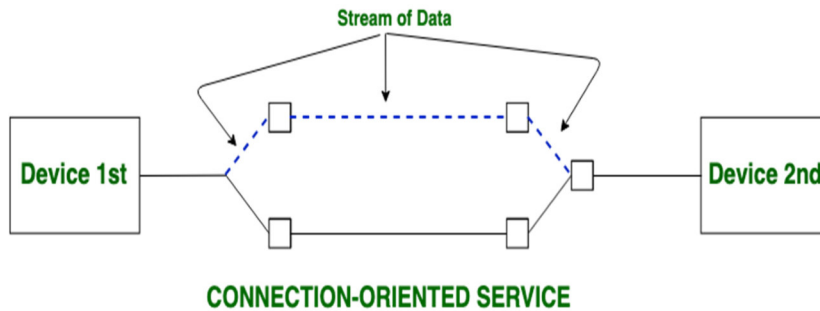

Fig. 2.4 Block Diagram of Connection-oriented Networks

2.6.2 Connection-less Networks

Connection-less network is related to the postal system. It does not include any connection establishment and connection termination. Connection-less Service does not give the guarantee of reliability. In this, Packets do not follow same path to reach destination.

It is similar to the postal networks services, as it carries the full address where the message (letter) is to be carried. Each message is routed independently from source to destination. The order of message sent can be different from the order received.

In connectionless network as shown in figure 2.5, the data is transferred in one direction from source to destination without checking that destination is still there or not or if it is ready to accept the message. Authentication is not required in this. Example of Connectionless service is UDP (User Datagram Protocol) protocol.

Space for learners

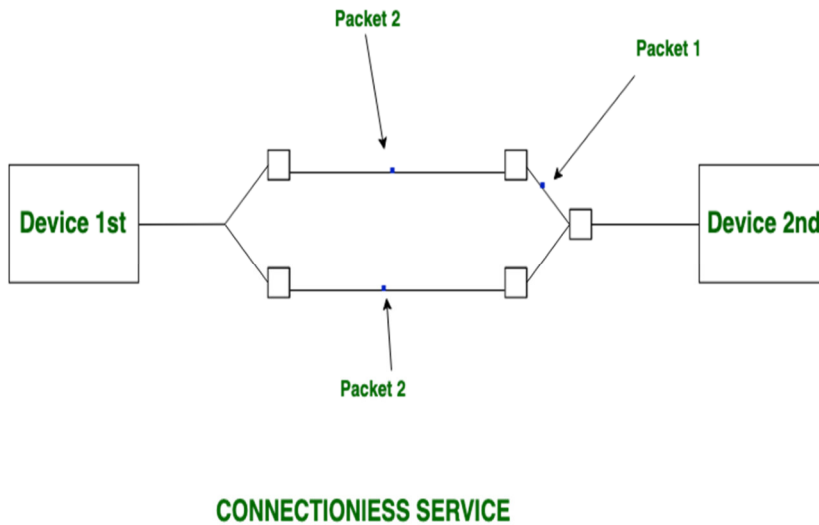

Fig. 2.5 Block Diagram of Connection-less Networks

2.6.3 Difference between Connection oriented and Connectionless networks

1. In connection-oriented networks, authentication is needed while connectionless networks do not need any authentication.
2. Connection oriented protocol makes a connection and checks whether message is received or not and sends again if an error occurs, while connectionless service protocol does not guarantee a message delivery.
3. Connection oriented networks is more reliable than connectionless networks.
4. Connection oriented networks interface is stream based and connectionless is message based.
5. Connection-oriented networks is feasible but Connection-less networks is not feasible.
6. Connection-oriented networks requires a bandwidth of high range but Connection-less networks requires a bandwidth of low range.

Space for learners

2.7 WIRELESS NETWORKS

The term 'wireless network' refers to two or more computers communicating using standard network rules or protocols, but without the use of cabling to connect the computers together. Instead, the computers use radio signals to send information from one to the other. A wireless local areanetwork (WLAN) consists of two key components: an access point (also called a base station) and a wireless card. Information can be transmitted between these two components as long as they are fairly close together (up to 100 metres indoors or 350 metres outdoors). A WLAN can be installed as the sole network in a school or building. However, it can also be used to extend an existing wired network to areas where wiring would be too difficult or too expensive to implement, or to areas located away from the main network or main building. Wireless networks can be configured to provide the same network functionality as wired networks, ranging from simple peer-to-peer configurations to largescale networks accommodating hundreds of users.

2.7.1 Wireless Network Components

There are certain parallels between the equipment used to build a WLAN and that used in a traditional wired LAN. Both networks require network interface cards or network adapter cards. A wireless LAN PC card, which contains an in-built antenna, is used to connect notebook computers to a wireless network. Usually, this is inserted into the relevant slot in the side of the notebook, but some may be internal to the notebook. Desktop computers can also connect to a wireless network if a wireless network card is inserted into one of its internal PCI slots.

In a wireless network, an 'access point' has a similar function to the hub in wired networks. It broadcasts and receives signals to and from the surrounding computers via their adapter card. It is also the point where a wireless network can be connected into an existing wired network.

The most obvious difference between wireless and wired networks, however, is that the latter uses some form of cable to connect computers together. A wireless network does not need cable to form a physical connection between computers.

Space for learners

Wireless Networks can be divided into three main categories:

1. **System interconnection**
2. **Wireless LANs**
3. **Wireless WANs**

2.7.2 System Interconnection

System interconnection is all about interconnecting the components of a computer using **short-range radio**. Some companies got together to design a short-range wireless network called **Bluetooth** to connect various components such as monitor, keyboard, mouse and printer, to the main unit, without wires. Bluetooth also allows digital cameras, headsets, scanners and other devices to connect to a computer by merely being brought within range.

In simplest form, system interconnection networks use the master-slave concept. The system unit is normally the **master**, talking to the mouse, keyboard, etc. as **slaves**.

2.7.3 Wireless LANs

These are the systems in which every computer has a **radio modem** and **antenna** with which it can communicate with other systems. Wireless LANs are becoming increasingly common in small offices and homes, where installing **Ethernet** is considered too much trouble. There is a standard for wireless LANs called **IEEE 802.11**, which most systems implement and which is becoming very widespread.

Wireless LANs have advantages and disadvantages when compared with wired LANs. A wireless LAN will make it simple to add or move workstations, and to install access points to provide connectivity in areas where it is difficult to lay cable. Temporary or semi-permanent buildings that are in range of an access point can be wirelessly connected to a LAN to give these buildings connectivity. Where computer labs are used in students, the computers (laptops) could be put on a mobile cart and wheeled from classroom to classroom, providing they are in range of access points. Wired network points would be needed for each of the access points.

Space for learners

2.7.3.1 Advantages of a WLAN

- It is easier to add or move workstations
- It is easier to provide connectivity in areas where it is difficult to lay cable
- Installation can be fast and easy and can eliminate the need to pull cable through walls and ceilings
- Access to the network can be from anywhere in the school within range of an access point
- Portable or semi-permanent buildings can be connected using a wireless LAN
- Where laptops are used, the 'computer suite' can be moved from classroom to classroom on mobile carts
- While the initial investment required for wireless LAN hardware can be similar to the cost of wired LAN hardware, installation expenses can be significantly lower
- Where a school is located on more than one site (such as on two sides of a road), it is possible with directional antennae, to avoid digging trenches under roads to connect the sites
- In historic buildings where, traditional cabling would compromise the façade, a wireless LAN can avoid drilling holes in walls
- Long-term cost benefits can be found in dynamic environments requiring frequent moves and changes
- They allow the possibility of individual pupil allocation of wireless devices that move around the school with the pupil.

2.7.3.2 Disadvantages of a WLAN

- As the number of computers using the network increases, the data transfer rate to each computer will decrease accordingly.
- As standards change, it may be necessary to replace wireless cards and/or access points. Lower wireless bandwidth means some applications such as video streaming will be more effective on a wired LAN.
- Security is more difficult to guarantee, and requires configuration.
- Devices will only operate at a limited distance from an access point, with the distance determined by the standard used and buildings and other obstacles between the access point and the user.

- A wired LAN is most likely to be required to provide a backbone to the wireless LAN; a wireless LAN should be a supplement to a wired LAN and not a complete solution.
- Long-term cost benefits are harder to achieve in static environments that require few moves and changes.
- It is easier to make a wired network ‘future proof’ for high data transfer.

2.7.4 Wireless WANs

The radio network used for cellular telephones is an example of a low-bandwidth wireless WAN. This system has already gone through three generations.

- The first generation was analog and for voice only.
- The second generation was digital and for voice only.
- The third generation is digital and is for both voice and data.

The block diagram of wireless WAN is depicted in figure 2.6.

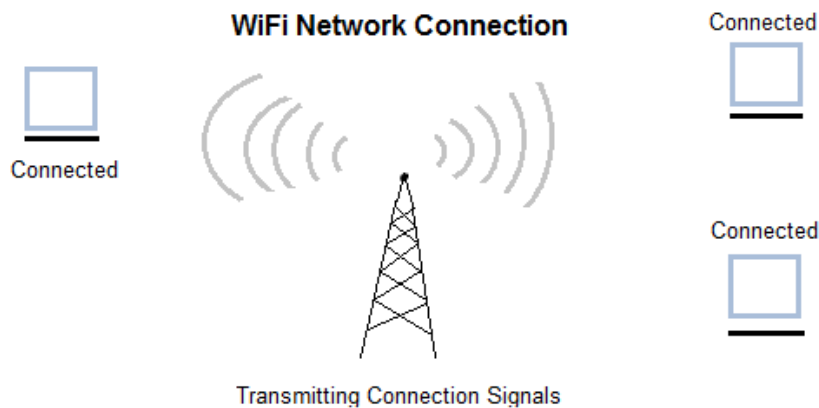

Fig. 2.6. Block Diagram of Wireless WAN

2.8 NETWORK TOPOLOGY

The term Network topology refers to the way in which a network is laid out physically. Two or more devices connect to a link; two or

Space for learners

more links form a topology. The topology of a network is the geometric representation of the relationship of all the links and linking devices (usually called nodes) to one another. There are five basic topologies which are found in computer networks, namely mesh, star, bus, ring and hybrid topology.

Space for learners

2.8.1 Mesh Topology

A mesh topology is the one where every node is connected to every other node in the network. A mesh topology can be a **full mesh topology** or a **partially connected mesh topology**. In a *full mesh topology*, every computer in the network has a connection to each of the other computers in that network. The number of connections in this network can be calculated using the following formula (n is the number of computers in the network): $n(n-1)/2$.

In a *partially connected mesh topology*, at least two of the computers in the network have connections to multiple other computers in that network. It is an inexpensive way to implement redundancy in a network. In the event that one of the primary computers or connections in the network fails, the rest of the network continues to operate normally.

Advantages of a mesh topology

- Can handle high amounts of traffic, because multiple devices can transmit data simultaneously.
- A failure of one device does not cause a break in the network or transmission of data.
- Adding additional devices does not disrupt data transmission between other devices.

Disadvantages of a mesh topology

- The cost of implement is higher than other network topologies, making it a less desirable option.
- Building and maintaining the topology is difficult and time consuming.
- The chance of redundant connections is high, which adds to the high costs and potential for reduced efficiency.

2.8.2 Star Topology

A star topology is one of the most common network setups. In this configuration, every node connects to a central network device, like a hub, switch, or computer. The central network device acts as a server and the peripheral devices act as clients. Depending on the type of network card used in each computer of the star topology, a coaxial cable or a RJ-45 network cable is used to connect computers together.

Advantages of star topology

- Centralized management of the network, through the use of the central computer, hub, or switch.
- Easy to add another computer to the network.
- If one computer on the network fails, the rest of the network continues to function normally.
- The star topology is used in local-area networks (LANs), High-speed LANs often use a star topology with a central hub.

Disadvantages of star topology

- Can have a higher cost to implement, especially when using a switch or router as the central network device.
- The central network device determines the performance and number of nodes the network can handle.
- If the central computer, hub, or switch fails, the entire network goes down and all computers are disconnected from the network.

2.8.3 Bus Topology

A line topology, a **bus topology** is a network setup in which each computer and network devices are connected to a single cable or backbone.

Advantages of bus topology

- It works well when you have a small network.
- It is the easiest network topology for connecting computers or peripherals in a linear fashion.
- It requires less cable length than a star topology.

Disadvantages of bus topology

- It can be difficult to identify the problems if the whole network goes down.
- It can be hard to troubleshoot individual device issues.
- Bus topology is not great for large networks.
- Terminators are required for both ends of the main cable.
- Additional devices slow the network down.
- If a main cable is damaged, the network fails or splits into two.

2.8.4 Ring Topology

A **ring topology** is a network configuration in which device connections create a circular data path. In a ring network, packets of data travel from one device to the next until they reach their destination. Most ring topologies allow packets to travel only in one direction, called a **unidirectional** ring network. Others permit data to move in either direction, called **bidirectional**.

The major disadvantage of a ring topology is that if any individual connection in the ring is broken, the entire network is affected. Ring topologies may be used in either local area networks (LANs) or wide area networks (WANs).

Advantages of ring topology

- All data flows in one direction, reducing the chance of packet collisions.
- A network server is not needed to control network connectivity between each workstation.
- Data can transfer between workstations at high speeds.
- Additional workstations can be added without impacting performance of the network.

Disadvantages of ring topology

- All data being transferred over the network must pass through each workstation on the network, which can make it slower than a star topology
- The entire network will be impacted if one workstation shuts down.

Space for learners

□ The hardware needed to connect each workstation to the network is more expensive than Ethernet cards and hubs/switches.

Space for learners

2.8.5 Hybrid Topology

A network can be hybrid. A hybrid topology consists of more than one different topologies like bus, star, ring or mesh topologies. For example, we can have a main star topology with each branch connecting several stations in a bus topology. Hybrid topology has all features of various topologies, so a hybrid topology has more advantages as well as disadvantages of different topologies.

2.9 INTERNETWORK

Internetwork or Internet is a combination of two or more networks. Inter network can be formed by joining two or more individual networks by means of various devices such as routers, gateways and bridges.

A network of networks is called an internetwork, or simply the internet. It is the largest network in existence on this planet. The internet hugely connects all WANs and it can have connection to LANs and Home networks. Internet uses TCP/IP protocol suite and uses IP as its addressing protocol. Present day, Internet is widely implemented using IPv4. Because of shortage of address spaces, it is gradually migrating from IPv4 to IPv6. Figure 2.7 presents the block diagram of internetwork.

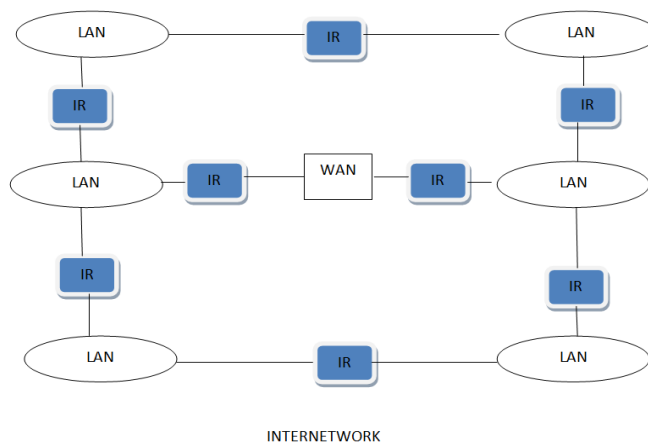

INTERNETWORK
Fig. 2.7 Block Diagram of Internetwork

Internet enables its users to share and access enormous amount of information worldwide. It uses WWW, FTP, email services, audio, and video streaming etc. At huge level, internet works on Client-Server model.

Internet uses very high speed backbone of fiber optics. To interconnect various continents, fibers are laid under sea known to us as submarine communication cable.

Internet is widely deployed on World Wide Web services using HTML linked pages and is accessible by client software known as Web Browsers. When a user requests a page using some web browser located on some Web Server anywhere in the world, the Web Server responds with the proper HTML page. The communication delay is very low.

Internet is serving many proposes and is involved in many aspects of life. Some of them are:

- Web sites
- E-mail
- Instant Messaging
- Blogging
- Social Media
- Marketing
- Networking
- Resource Sharing
- Audio and Video Streaming

CHECK YOUR PROGRESS

Multiple Choice Questions:

1. Aset of rules that govern data communications is known as
(A) Protocol (B) Service
(C) Procedure (D) Interface
2. Broadcast networks are also known as

Space for learners

- (A) MAN (B) LAN (C) Wireless network
(D) Terrestrial networks

3. The smallest and most basic type of network is known as

- (A) LAN (B) MAN (C) PAN
(D) WAN

4. A topology which is the one where every node is connected to every other node in the network is known as

- (A) Star Topology
(B) Ring Topology
(C) Mesh Topology
(D) Bus Topology

5. The radio network used for cellular telephones is an example of a low-bandwidth is

- (A) Wireless LAN
(B) Wireless WAN
(C) Wireless MAN
(D) Wireless PAN

Space for learners

2.10 SUMMING UP

- A network is any collection of independent computers that communicate with one another over a shared network medium. A computer network is a collection of two or more connected computers.
- A protocol is a set of rules that govern data communications. It represents an agreement between the communicating devices.
- Data communication networks have become an indispensable part of business, industry, and entertainment.
- Computer networks based on transmission media technology is basically divided into two categories: Broadcast Networks and Point-to-Point Networks.
- Broadcast networks are also known as terrestrial networks. Broadcasting is simply method of transferring message to all of recipients simultaneously.
- Point-to-Point Networks or Point-to-Point Connection is type of private data connection that is connecting securely two or more locations for private data services.

- The types of networks are classified based upon the size, the area it covers and its physical architecture. The three primary network categories are LAN, WAN and MAN.
- Computer Networks can be divided in to two main categories based on computer connected(i)Peer-to-peer and (ii) Server-based.
- There are two categories of computer networks found based on the connection set-up services.These are: (i) Connection Oriented Networks and (ii) Connection-less Networks.
- The term 'wireless network' refers to two or more computers communicating using standard network rules or protocols, but without the use of cabling to connect the computers together.
- The radio network used for cellular telephones is an example of a low-bandwidth wireless WAN.
- The term Network topology refers to the way in which a network is laid out physically.
- There are five basic topologies we have found in computer networks, which are: mesh, star, bus, ring and hybrid topology.
- Internetwork or Internet is a combination of two or more networks. Inter network can be formed by joining two or more individual networks by means of various devices such as routers, gateways and bridges.

Space for learners

2.11 ANSWER TO CHECK YOUR PROGRESS

1. (A),
2. (D),
3. (C),
4. (C),
5. (B)

2.12 POSSIBLE QUESTIONS

Short Type Questions:

1. What is Computer Network? What are its different types?
2. How point -to-point networks differ from broadcast networks?
3. What do you mean by client-server networks?

4. What is networks topology?
5. What do you mean internetwork? What are its advantages?

Long Answer Type Questions:

1. Explain the uses of Computer Networks.
2. Explain different categories of computer networks based on area (size) covered.
3. Explain the difference between the connection oriented and connection-less networks.
4. Explain different categories of network topologies.
5. What is a wireless network? Explain its different types.

2.13 REFERENCES AND SUGGESTED READINGS

- Andrew S. Tanenbaum, COMPUTER NETWORKS,Fourth Edition, Prentice-Hall India (PHI) EASTERN ECONOMY EDITION (EEE).
- William Stallings, DATA COMPUTER COMMUNICATIONS, Eight Edition, PEARSON EDUCATION PUBLICATION.

Space for learners

UNIT 3: NETWORK STANDARDS

Unit Structure:

- 3.1 Introduction
- 3.2 Unit Objectives
- 3.3 The IEEE Standards
- 3.4 The OSI Reference Model
- 3.5 The TCP/ IP Reference Model
- 3.6 Comparison of the OSI and TCP/IP Reference Models
- 3.7 Design Issues for the Layers
- 3.8 Connection-oriented and Connectionless Service
- 3.9 Service Primitives
- 3.10 Introduction to X.25 and Frame Relay
- 3.11 Summing Up
- 3.12 Answers to Check Your Progress
- 3.13 Possible Questions
- 3.14 References and Suggested Readings

3.1 INTRODUCTION

This unit is to understand the requirement of the network standards for exchanging the information among different set of computers or networking devices. This is known to all of us that several vendors/manufacturers with their own technologies and processes are in the market for producing hardware and software networking products. Therefore, for ensuring the data communication with such heterogenous set of technologies and processes, some set of the formats or rules are to be in the place to be followed by the vendors/manufactures for addressing the interoperability of the networking technologies and processes. So, Network Standards can be defined as the set of rules or well defined formats for data communications needed for exchange of information among the different set of heterogenous technologies and processes developed by different vendors at different levels.

Space for learners

This unit focuses on the IEEE standards used for wired and wireless communication medium, and also about the reference model like OSI reference model and TCP/IP reference model. Reference model in data communication is a conceptual framework for standardizing the communication between heterogeneous networks. These conceptual frameworks are composed of several interconnected levels/ layers, and each layer is responsible for performing particular networking functions independently. Basically, a reference model describes how information from a running application at one machine moves through a physical medium to another running application at the remote computer by crossing different layers. At each layer, certain networking functionalities as defined by that layer network protocols are performed.

Space for learners

3.2 UNIT OBJECTIVES

After going through this unit, you will be able to:

- Know about different IEEE standards with respect to LAN and WLAN under Project 802
- Understand the OSI Reference model
- Relate the requirements of TCP/IP reference model
- Define the design issues and functionalities of different layers of OSI reference model
- Describe the Connectionless and Connection-oriented services, along with Service primitives
- Understand the basics of X.25 and Frame Relay

3.3 THE IEEE STANDARDS

Standards are the only way through which compatibility and interoperability can be ensured by establishing the specifications and procedure to be followed during the design, development and deployment of any product or services. In computer network, these standards are nothing but some published documents mentioning the fundamental building blocks of network devices, services and its working protocols which are universally understood and adopted.

IEEE is an organization which stands for “Institute of Electrical and Electronics Engineers”. It started a project named “Project 802” in the year 1985 for specifying the standards for enabling

intercommunication among different network devices and services designed by different vendors/ manufacturers at different levels. Most importantly, the standards specified by the “Project 802” are for defining the functions of the physical layer and the data link layer of popular LAN protocols. The standards specified by the “Project 802” are defined in such a way that the standards do not deviate from OSI reference model concept, and hence the same was adopted by the American National Standard Institute (ANSI) and subsequently by the International Standard Organization (ISO) in the year 1987. Although none of the part of the OSI reference model was replaced by the “Project 802”, the IEEE has subdivided the Data Link layer of the OSI reference model into two sub-layers, known as Logical Link Control sub-layer and Media Access Control sub-layer. Some of the important IEEE 802.x standards are highlighted in the following-

- IEEE 802.1 - An IEEE 802.x standard looked after by IEEE 802.1 working group for defining the architecture, security, management and internetworking of Local Area Network (LAN), Metropolitan Area Network (MAN) and Wide Area Network (WAN).
- IEEE 802.2 – An IEEE 802.x standard for defining the functions and working of upper sub-layer of Data Link Layer called Logical Link Control sub-layer; which is responsible for providing a uniform interface to the user of the data link service, usually the network layer.
- IEEE 802.3 – An IEEE 802.x standard commonly known as Ethernet, which defines the standards and specifications of physical layer and data-link layer in terms of Media Access Control (MAC) mechanism of wired connections like Carrier-sense multiple access with collision detection (CSMA/CD) method.
- IEEE 802.4 - This is IEEE 802.x standard looked after by IEEE 802.4 working group for defining the specifications and functionalities with respect to (w.r.t.) implementation of Token Bus network access method.
- IEEE 802.5- Like IEEE 802.x standard, this standard is for defining the specifications and functionalities w.r.t.

Space for learners

implementation of Token Ring for building local area network and was initially introduced by IBM in the year 1984. This is about the access method of the token passed through logical ring LAN.

- IEEE 802.6 – This standard is based on Distributed Queue Dual Bus (DQDB) concept w.r.t. Metropolitan Area Network for achieving high speed shared medium access control used over the bus network.
- IEEE 802.7 – This standard focuses and specifies on achieving the capabilities of delivering voice and video traffic through broadband LANs.
- IEEE 802.9 – The IEEE 802.9 working group of this standard defines a unified access method for offering integrated voice and data access mechanism over the existing Category 3 twisted-pair LANs.
- IEEE 802.10 – This standard is about specifying the virtual LANs and security concerns through an interoperable data link layer security protocol and associated security services.
- IEEE 802.11 - This is an important and popular standards used in day-to-day activities of the Wireless LANs (WLANs); which defines standards for wireless media access control mechanism along with its physical layer specifications.
- IEEE 802.12 – The Demand Priority Access control mechanism is specified by this standard and it is used by 100 Mb/s 100 VG-AnyLAN networks. The layer management, physical layers and media access method supported media are also considered in this standard.
- IEEE 802.14 - This standard specifies the working of cable TV based broadband communications.
- IEEE 802.15 – This is also an important and popular standards used in several communication platform w.r.t. establishment of Personal Area Network like Bluetooth technology that specifies physical layer and media access control. This also specifies Body Area Network; which

Space for learners

specifies physical layer and media access control of low-rate wireless personal area networks (LR-WPANs).

- IEEE 802.16 – This standard is for specifying the technical details achieving the broadband connectivity through wireless metropolitan area networks (WMANs), and such technology is WiMAX.

Although the above mentioned 14 numbers of IEEE standards are not active at the present time, same has been highlighted to understand the background of the IEEE standards and its purposes. Some of them are either in the status of ‘hibernating’ or ‘gave up and disbanded itself’ at this present time.

CHECK YOUR PROGRESS - I

Fill up the blanks:

1. IEEE stands for _____.
2. Logical Link Control sub-layer is sub-layer of _____.
3. Ethernet is based on IEEE _____ standard
4. LR-WPANs stands for _____.

State TRUE or FALSE:

5. IEEE 802.11 defines standards for wireless media access control mechanism along with its physical layer specifications.
6. CSMA/CD stands for “Carrier-sense multiple access with collision disturbance”.
7. Media Access Control sub-layer is sub-layer of Data Link layer.

Space for learners

3.4 THE OSI REFERENCE MODEL

This is a reference model or layered architecture for computer network, which is proposed, developed and designed by International Standard Organization (ISO) to deal with open systems, i.e. the systems which are open for communication with

other systems, and hence it is termed as Open System Interaction (OSI).

There are seven layers in the ISO OSI Reference model, and they are Physical layer, Data Link Layer, Network Layer, Transport Layer, Session Layer, Presentation Layer and Application Layer. The Physical Layer is the bottom most layer, and the Application Layer is the top most layer in this layered architecture as shown in the following figure-3.1.

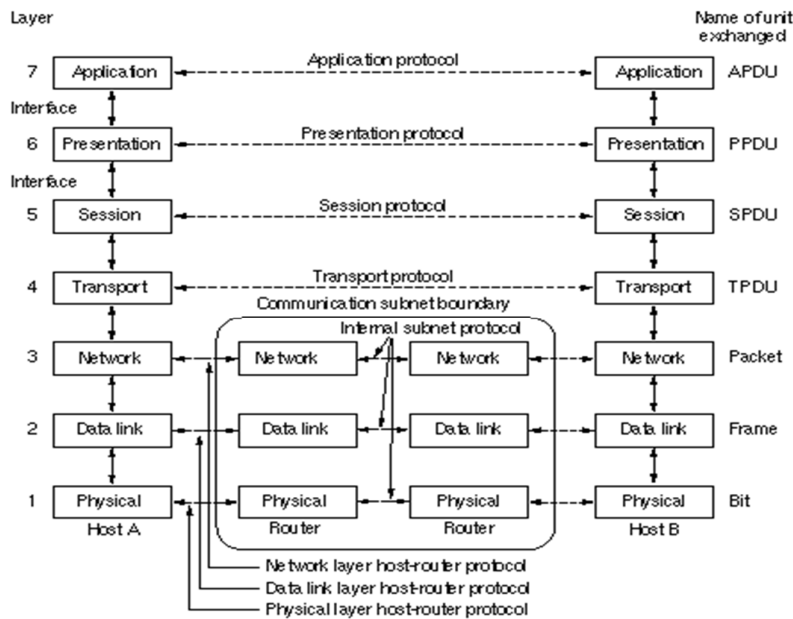

Figure 3.1- OSI Reference Model

[Source- Andrew S. Tanenbaum, Computer Networks, Pearson]

Each layer of the reference model is designed in such a way that each of the layers are capable of performing a well defined function, so that internationally standardized protocols can be accommodated through those functions, while minimizing the information flow across the layered interfaces. A protocol is an agreement between two machines as how communication link should be established, maintained and released.

- **The Physical Layer-** This layer is responsible for transmitting raw bits (0's and 1's) over a communication medium. Hence, the physical layer receives the bits to be

transmitted from the data link layer, and at the receiving end, physical layer hands over these bits to the data link layer. Therefore, this layer is for providing the bit transport service from the data link layer of sending machine to the data link layer of receiving machine. Basically, this layer defines voltages and data rates, converts data bits into electrical signals, recognizing the transmission as simplex or half duplex or full duplex, etc. To be summarized the concern of this layer is- to play the role of interface between machine and transmission medium; to define the type of transmission medium; regarding bits encoding into electrical or optical signals, regarding transmission rate; regarding physical topology, regarding transmission mode etc.

- **The Data Link Layer-** This layer provides the facility for transforming a raw transmission facility into a line that appears free of undetected transmitted errors to the network layer, by considering synchronization and error detection/correction. Other responsibilities of this layer are- Framing (dividing the stream of bits received from the network layer into manageable data units, and this data units are known as frame); Physical Addressing (by adding the header to the frame for defining the sender and /or receiver of the frame); Flow Control (for avoiding overwhelming the receiver); Error Control (by adding a trailer into the frame for ensuring reliability through detection of erroneous/ damaged or lost frames followed by retransmission of the same); Access Control (for determining the machine that has control over the communication link at any given time, whenever two or more machines are connected to the same link).
- **The Network Layer-** One important role of this layer is to control the operation of subnets, and to ensure the delivery of data packets from source to destination based on different routing protocols. This is to be mentioned that if two machines are connected to two different networks with connecting devices between the networks, there is a need of network layer for accomplishing the delivery of data packets from source to destination; otherwise, the data link layer itself can handle the delivery of data from source to destination if both the machines are within the same network. The responsibility like implementation of Logical

Space for learners

Addressing (by adding a header over the data packets, which includes logical addresses, i.e. IP addresses of the sender and receiver) is also to be considered by the network layer; and the responsibility like implementation of Routing (to incorporate mechanisms through connecting devices like router/ layer-3 switch for ensuring data packets to be routed to their final destinations; whenever internetworks are created by connecting the independent networks or links) is also part of the network layer.

- **The Transport Layer-** This layer is basically responsible for the delivery of the entire message from one application program running on a host to other one on a different host, by deciding whether the data messages are to follow the same (single) path or different (parallel) paths; and whether to break the data into smaller units by spitting the data. Transport layer includes the functionalities like Service-point Addressing (adding the service point/ port address into its header for specifying the designated process, i.e. specifying the running application process over the host); Segmentation and Reassembly (by dividing the message into transmittable segments with unique sequence numbers); Connection Control (whether to follow connectionless or connection oriented transmission of the segments); Flow Control (for avoiding overwhelming the receiver and it is performed at process-to-process level); Error Control (for ensuring reliability through detection of erroneous/ damaged or lost segments followed by retransmission of the same, and it is performed at process-to-process level).
- **The Session Layer-** This layer is for establishing sessions between the users on different machines, which include Dialog Control (for establishing a dialog between two systems so that communication between two processes can take place either in full-duplex, i.e. bi-direction at a time or in half-duplex mode, i.e. unidirectional at a time); synchronization (adding check points to a long stream of data under transmission, so that transmission can be continued form the last point just before a crash); Token Management (preventing two parties from attempting the same critical operation at the same time).

Space for learners

- **The Presentation Layer-** This layer plays the role as a translating layer by considering syntax and semantics of the information exchanged between two systems. To be specific, this includes Translation (for ensuring interoperability between different encoding methods, changing the information from sender-dependent bit streams format into common bit streams format at the sender side and the common bit streams format to receiver-dependent bit streams format at receiver); Encryption (means of securing digital data using one or more mathematical techniques); Compression (process of encoding information using fewer bits than the original representation).
- **The Application Layer-** This is a layer through which platform (user interface, support for services like electronic mail, remote file access & transfer, shared database management etc.) is provided to the user (human/ software) for accessing the network.

3.5 THE TCP/ IP REFERENCE MODEL

The Advanced Research Projects Agency Network (ARPANET) was the first wide-area packet-switched network with distributed control and one of the first networks to implement the TCP/IP protocol suite, which connected several universities and government installations through leased telephone lines. As the satellite and radio networks were included to it later on, the inclusion could not be handled by the existing protocols, and hence a new reference model was adopted for ensuring the ability to connect multiple networks (including satellite and radio networks) in a seamless way, and is known as TCP/IP reference model. This reference model has four layers namely Host-to-Network layer (Bottom-most one), Internet layer, Transport layer and Application layer (Top-most one).

- **The Host-to-Network Layer-** This layer is to point out that host has to connect to the network using some protocol for sending IP packets to it, and the protocol varies from network-to-network, and host-to-host.
- **The Internet Layer-** The function of this layer is almost similar to the network layer of the OSI reference model.

This layer specifies the packet format and protocol, called Internet Protocol, and the job is to deliver the IP packets through any network independently to the destination. So, the routing of packets and congestion control mechanism are also the important responsibilities of this layer. Internet Protocol also supports four supporting protocols- ARP (Address Resolution Protocol), RARP (Reverse Address Resolution Protocol), ICMP (Internet Control Message Protocol), IGMP (Internet Group Message Protocol).

- **The Transport Layer-** This layer in TCP/IP is represented by basic protocols like TCP (Transmission Control Protocol), UDP (User Datagram Protocol), SCTP (Stream Control Transmission Protocol). Both the protocols TCP & UDP are responsible for delivery of a message from a process (running application program) to another process. SCTP is devised to meet the needs of some newer applications like VoIP (Voice over Internet Protocol). This layer is almost similar with the transport layer of OSI reference model and is designed to allow peer entities on sender and receiver side to have communication.
- **The Application Layer-** This layer is a combined layer, composed of session layer, presentation layer and application layer of the OSI reference model. This layer contains some of the high-level protocols like TELNET (Teletype Network Protocol- used for enabling virtual terminal to log onto a remote machine); FTP (File Transfer Protocol- for providing a platform for transferring data from one machine to another), SMTP (Simple Mail Transfer Protocol- for electronic mail), DNS (Domain Name System- for mapping host names onto their network address), HTTP (Hypertext Transfer Protocol- to fetch pages on WWW and others), etc.

Space for learners

3.6 COMPARISON OF THE OSI AND TCP/IP REFERENCE MODELS

Although both the reference models are based on the concept of independent protocol stack, and the functionalities of both the model

are almost similar, there are certain differences also as illustrated below-

- OSI Reference model has 7 (Seven) layers, but TCP/IP Reference model has 4 (Four) layers.
- OSI Reference model distinguishes the services, interfaces and protocols very clearly; whereas TCP/IP Reference model does not.
- In OSI Reference model came first before the existence of the corresponding protocols; whereas in TCP/IP Reference model, protocols came first, and the model is just a description of the existing protocols.
- The protocols in OSI Reference model are better hidden than the TCP/IP Reference model, and can be replaced relatively easily as technology changes.
- Network layer of the OSI Reference model supports both connectionless and connection-oriented communication, but only connectionless communication is supported in the network layer of the TCP/IP Reference model.
- Transport layer of the OSI Reference model supports only connection-oriented communication, but both connectionless and connection-oriented communication are supported in the transport layer of the TCP/IP Reference model.
- OSI Reference model has separate session layer; whereas no session layer is available in the TCP/IP Reference model. Characteristics of the session layer in TCP/IP Reference model is provided by the transport layer.
- OSI Reference model has separate presentation layer; whereas no presentation layer available in the TCP/IP Reference model. Characteristics of the presentation layer in TCP/IP Reference model is provided by the application layer.

3.7 DESIGN ISSUES FOR THE LAYERS

There are several design issues for the layers like- Addressing, Rules for data transfer, Error Control, Segmentation of data,

Space for learners

Sequencing, Flow Control, Multiplexing and de-multiplexing, Routing etc.

- **Addressing-** Several machines can form a network, and each machine may have multiple processes, and hence source processes must have to identify the destination processes. As result, layers must be capable of providing a mechanism for specifying the source and destination.
- **Rules for data transfer-** Layers must consider the protocols for determining whether data transfer over the channel is unidirectional or bidirectional. Moreover, numbers of logical channels and their priorities also have to be determined by the protocol.
- **Error Control-** Errors in the data stream may be introduced during the communication over the unreliable channels and hence layers must be in consensus on common error detection and correction mechanisms.
- **Segmentation of data-** Mechanism for disassembling, transmitting and then reassembling of the messages are to be accepted by the layers.
- **Sequencing-** There is a chance of loss of sequencing, as communication channel may not preserve the order of the data pieces sent on it. Therefore, layers should allow mechanisms for numbering of pieces, so that all pieces can be received in the receiver in the appropriate sequence.
- **Flow Control-** Keeping a fast receiver from overwhelming a slow receiver is an important issue, and mechanisms for that must be ensured in the layers.
- **Multiplexing and de-multiplexing-** For enabling the sharing of same channel by many sources simultaneously, multiplexing and de-multiplexing mechanisms are required and that has to be agreed by the layers.
- **Routing-** There may be multiple paths from the source to the destination. Routing involves choosing an optimal path among all possible paths, in terms of cost and time, and hence mechanisms for implementing routing algorithm have to be considered by the layers.

Space for learners

CHECK YOUR PROGRESS - II

Fill up the blanks:

8. Layers in the OSI Reference model starting from uppermost are Application, ____, ____, Transport, ____, ____, Physical.

9. Data Link layer divides the stream of bits received from the network layer into manageable data units, and this data units are known as _____.

10. RARP stands for _____.

11. Process of encoding information using fewer bits than the original representation is known as _____.

12. Congestion control mechanism is role of _____ layer in TCP/IP reference model.

State TRUE or FALSE:

13. TCP/IP reference model has seven layers.

14. Only connection-oriented communication is supported in the transport layer of the TCP/IP Reference model.

15. Multiplexing means keeping a fast receiver from overwhelming a slow receiver.

Space for learners

3.8 CONNECTION-ORIENTED AND CONNECTIONLESS SERVICE

Quality of Service (QoS) is the underlying factor for which two different services i.e. Connection-Oriented service and Connectionless service have been characterized. In this context, QoS is only about the reliable communication or unreliable communication as per the service requirement.

For having a reliable service, generally communication mechanisms ensure the acknowledgement of the received messages from the receiver side to the sender side regarding the correct reception, but these acknowledgements may introduce undesirable overheads and delay. For some applications like digitized voice traffic, those

overheads and delay is not required and may not be acceptable. Whereas, application like file transfer requires reliable service where the owner of the file wants to be sure that all the bits arrived correctly and in the same order they were sent. Therefore, looking at the need of the service requirements of the applications, two categories of services are considered and they are Connectionless and Connection-oriented service.

Connection-oriented service is designed based on the traditional telephone system, and hence in this service, the service user first establishes a connection, uses the connection, and then releases the connection. There are situations, where negotiations in terms of maximum message size, quality of service requirement, etc. may be required between the sender and receiver in the connection-oriented service.

Connectionless service is designed based on the postal system, and hence in this service, each message contains the full destination address, and each one message may be routed through the network being independent of all others. In this service, there may be situation, where one message may be arrived at the receiver before the previous messages. Unreliable connectionless service is known as datagram service. There is also acknowledged datagram service in which reliability is essential, but establishment of connection is not considered.

3.9 SERVICE PRIMITIVES

During the data transmission in the layered model, be it OSI reference model or TCP/IP reference model; each layer is dependent on the defined functionalities to be provided by its adjacent layers on the same machine and hence services play the role as interfaces between the adjacent layers for providing such functionalities to the upper layers from its adjacent lower layers. For providing such functionalities, services define the operations only like a calling function, but not the implementation details of it. Service can be imagined as the object of the object oriented programming concept, which defines operations to be performed on an object without specifying the implementation details of the operations.

Space for learners

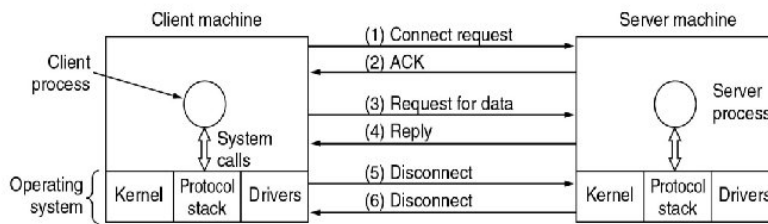

Figure 3.2- Connection oriented client-server interaction

[Source- Andrew S. Tanenbaum, *Computer Networks*, Pearson]

The operations provided by the service are termed as service primitives, and hence a service can be considered as composition of primitives through which a process or an entity can access the service. A service primitive is implemented as a system call that transfers the control of the processor to its kernel code for performing necessary functions in order to achieve the partial requirements of the service. The set of the service primitives are different for different services based on its type and requirement; and therefore, service primitives for connection-less and connection-oriented services are also different. For better understanding about service primitives, one may consider an example of implementation of sending packets through a simple client-server interaction in a reliable way; and the service primitives that may be needed to implement such scenario are LISTEN, CONNECT, RECEIVE, SEND, and DISCONNECT.

For such a scenario, the server process will execute the LISTEN primitive as the blocking system call and after execution of the LISTEN primitive, the server process gets blocked till an incoming connection request is received, so that the server process can make itself prepared to accept an incoming connection. Now, the client process will execute the CONNECT primitive by specifying whom to connect using the server's address and after execution of the CONNECT primitive, the client process gets suspended till the response is received, so that a connection between the client and server can be established. Executing CONNECT primitive can be seen as executing a system call, for which the operating system sends a packet to the server concerned asking it to connect. Once the packet asking for a connection is received at the server end, the same will be processed by the server's operating system and if the packet is meant for requesting a connection, the server process will

Space for learners

be unblocked and an acknowledgement will be sent back to the client requesting for a new connection. The unblocking of the server process followed by sending the acknowledgement to the client side will be performed only if there is a valid listener at the server side; otherwise, the packet asking for the connection will be queued at the server side for some little amount of time. After receiving the acknowledgement at the client side, the suspension of the client process will be released immediately, and hence the connection between the running client process and running server process is established now. On the other hand, the server side will also execute the RECEIVE primitive immediately after being released from the block state made by LISTEN primitive. This RECEIVE primitive should be executed in a way so that execution of the same occurs before reaching the acknowledgement at the client side, and after execution of the RECEIVE primitive server process gets blocked again in order to make the server ready for accepting the request of data to be sent from client side. Again, on the client side, the SEND primitive will be executed to transmit its request for data, followed by execution of the RECEIVE primitives at the client side for getting the reply. After receiving the transmitted request at the server side, the blocked server process for the RECEIVE primitive will be unblocked for processing the request. Once the processing of the request is completed at the server side, the server side also executes the SEND primitive for sending the reply of the request of the client. Client process also gets unblocked whenever the reply packet is arrived from the server side, and immediately the client will perform the necessary processing with the received data as reply packet. As long as additional requests for data are needed from the client side, the client and server side will execute both the primitives SEND and RECEIVE in the same way as discussed for each additional request for data; otherwise client side will execute DISCONNECT primitive in order to terminate the connection, for which the client process will be blocked after sending the packet requesting the server to terminate the connection, and the client process will released once server's packet will be received informing that connection is closed. Again, after receiving the packet requesting to terminate the connection at the server side, the server process gets released followed by execution of the DISCONNECT primitive for acknowledging the client regarding termination of the connection. Therefore, the client process also gets released after receiving the acknowledgement

Space for learners

packet and finally the connection between the client and server is no more.

The above discussion for uses of the five service primitives to implement a simple connection-oriented service can be understood in a nutshell by the figure-3.3.

Primitives	Meaning
LISTEN	Block waiting for an incoming connection
CONNECT	Establish a connection with a waiting peer
RECEIVE	Block waiting for incoming message
SEND	Send a message to the peer
DISCONNECT	Terminate a connection

Figure 3.3- Service primitives for connection-oriented service ^[1]

3.10 INTRODUCTION TO X.25 AND FRAME RELAY

X.25 is a virtual circuit switching technology or connection-oriented network, which was deployed in 1970's. X.25 is defined at three levels (Level 1, Level 2 and Level 3), which corresponds to the first three layers (Physical, Data link and Network) of OSI Reference model. X.25 technology is suitable for data traffic with a low 64-kbps data rate. During 1970's, transmission media were more prone to errors, and hence extensive flow and error control mechanisms were incorporated in X.25, and due to that, large overhead and slow-down transmissions were identified as the disadvantage of X.25. X.25 requires acknowledgements for data link layer frames, as well as network layer packets.

As a result, a new kind of virtual circuit wide area network technology called Frame Relay was introduced in 1980's by replacing the X.25. In Frame Relay technology, like X.25, connection-oriented network is considered, but without flow control and error control policies. Frame relay operates in only at the physical layer and data link layers, and it is designed in such a way that it can provide fast transmission capacity for more reliable media and also protocols which considers flow control and error control mechanisms at the higher layers.

Space for learners

CHECK YOUR PROGRESS - III

16. Unreliable connectionless service is known as _____.
17. The service which is designed based on the traditional telephone system, where the service user first establishes a connection, is known as _____ service.
- State TRUE or FALSE:***
18. RECEIVE is a service primitive.
19. X.25 does not consider error and flow control mechanisms, whereas Frame Relay considers the same.

3.11 SUMMING UP

- Network Standards can be defined as the set of rules or well defined formats for data communications needed for exchange of information among the different set of heterogenous technologies and processes developed by different vendors at different levels
- OSI Reference Model has 7 layers and TCP/IP Reference model has 4 Layers.
- Data Link layer of the OSI reference model into two sub-layers, known as Logical Link Control sub-layer and Media Access Control sub-layer.
- Connection-oriented service is designed based on the telephone system, whereas Connectionless service is designed based on the postal system.
- The operations provided by the service are termed as service primitives, and hence a service can be considered as composition of primitives through which a process or an entity can access the service.
- In Frame Relay technology, like X.25, connection-oriented network is considered, but without flow control and error control policies

3.12 ANSWERS TO CHECK YOUR PROGRESS

1. Institute of Electrical and Electronics Engineers
2. Data Link Layer
3. 802.3
4. low-rate wireless personal area networks
5. True
6. False
7. True
8. Presentation, Session, Network, Data Link
9. Frame
10. Reverse Address Resolution Protocol
11. Compression
12. Internet layer
13. False
14. False
15. False
16. Datagram
17. Connection-oriented
18. True
19. False

3.13 POSSIBLE QUESTIONS

Short answer type questions:

1. What do you mean by Network Standards?
2. What is the role of IEEE 802.3 Standards?
3. What is the role of IEEE 802.11 Standards?
4. Write the role of Physical layer in OSI Reference model?
5. Write the role of Data Link layer in OSI Reference model?
6. What are the sub-layers of Data Link Layer?

7. Write the functions of Network layer in OSI Reference model?
8. Write the functions of Transport layer in OSI Reference model?
9. What is the role of Application Layer in TCP/IP Reference model?
10. Why framing is required at data link layer?
11. Explain flow control functionality of Transport layer in OSI reference model.
12. What is the role of Internet layer in TCP/IP Reference model?
13. Give an example application using connection-less service, along with reasons.
14. What do you mean by service primitives?
15. Why Frame Relay is introduced after the X.25?

Long answer type questions:

1. Why the IEEE standards are important? Explain the roles of IEEE 802.3 and IEEE 802.11 standards.
2. Write the functions of uppermost three layers of OSI Reference Model?
3. How do you distinguish the OSI reference model and TCP/IP Reference model?
4. Explain Connectionless and Connection-oriented service.
5. Why Service primitives are important? List some of the service primitives with their meaning.
6. Write short note on X.25 and Frame Relay.

3.14 REFERENCES AND SUGGESTED READINGS

- Andrew S. Tanenbaum, Computer Networks, Pearson.
- Behrouz A Forouzan, Data Communications and Networking, The McGraw-Hill Companies

Space for learners

UNIT 4: THE PHYSICAL LAYER: INTRODUCTION TO DATA COMMUNICATION

Unit Structure:

- 4.1 Introduction to Physical Layer
- 4.2 Data Communication Concepts and Terminologies
 - 4.2.1 Data Representation
 - 4.2.2 Data Transmission Media and Channels
 - 4.2.3 Transmission Impairment
 - 4.2.4 Digital Transmission and Signal Encoding
- 4.3 Summing Up
- 4.4 Answers to Check Your Progress
- 4.5 Possible Questions
- 4.6 References and Suggested Readings

4.1 INTRODUCTION TO PHYSICAL LAYER

In Open System Interconnection (OSI) network model, physical layer plays the role of interacting with actual hardware and signaling mechanism. This layer deals with the physical connectivity of two different stations. It provides its service to data link layer. Physical layer converts them to electricity pulses, which represent binary data. Figure 1 presents the position of physical layer in OSI network model. The binary data is then sent over the wired or wireless media.

Space for learners

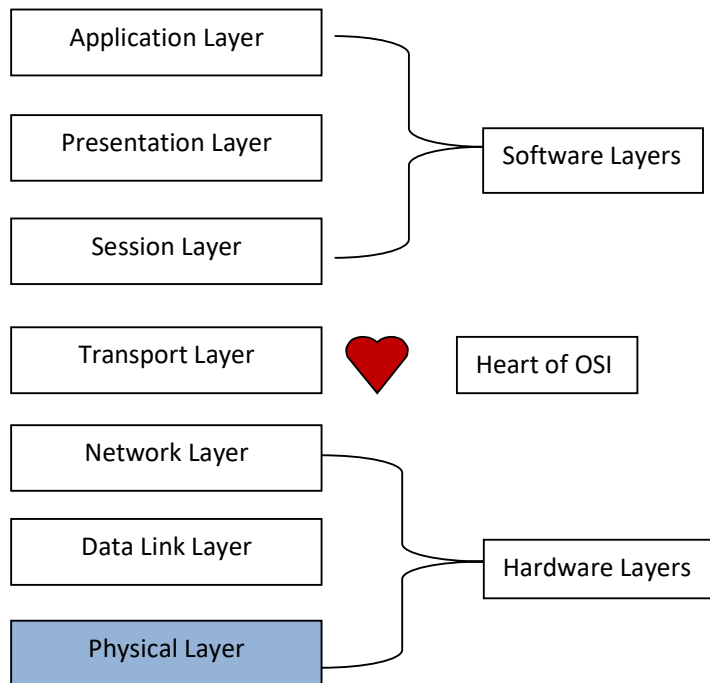

Figure 1. Physical Layer Position in OSI Model

Space for learners

STOP TO CONSIDER

In Physical Layer:

1. Protocols: COAX, FIBER, WIRELESS
2. Network Devices: Repeater/ HUB
3. Data Unit: Bit
4. Type of Layer: Hardware Layer
5. Functions: Bit Synchronization, Bit rate control, Physical Topologies, Transmission mode
6. Transmission Mode: Simplex, Half Duplex & Full Duplex
7. Link Configuration: Point to Point, Multi Point.

STOP TO CONSIDER

8. Physical Layers (0's, 1's)-> Data Link Layer (used Frames)

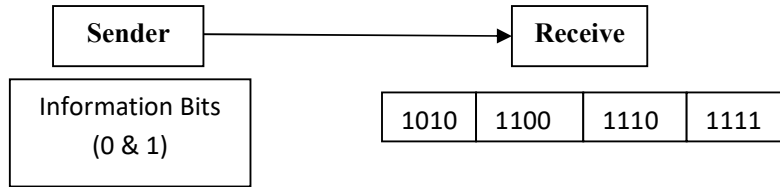

Space for learners

CHECK YOUR PROGRESS - I

1. Choose the correct option from the following:

a) What is the data unit of Physical Layer?

1. Data
2. Packets
3. Bit
4. Frame

b) Repeaters operate in which layer?

1. Application Layer
2. Presentation Layer
3. Physical Layer
4. Network Layer

4.2 DATA COMMUNICATION CONCEPTS AND TERMINOLOGIES

Space for learners

4.2.1. Data Representation

Computer does not understand human language, so, any data, like letters, symbols, and pictures, audio, video, etc. should be converted to machine language. Computer represents data in three forms:

1) Number System, 2) Bits and Bytes and 3) Text Code

1) Number System: It is categorised into four types:

- Binary number system consists of only two values, either 0 or 1.
- Octal number system represents values in 8 digits.
- Decimal number system represents values in 10 digits.
- Hexadecimal number system represents values in 16 digits.

STOP TO CONSIDER

Number System:

System	Base	Digits
Binary	2	0 1
Octal	8	0 1 2 3 4 5 6 7
Decimal	10	0 1 2 3 4 5 6 7 8 9
Hexadecimal	16	0 1 2 3 4 5 6 7 8 9 A B C D E F

2) Bits and Bytes: Bits: It is smallest possible unit of data that computer can recognize or use.

Bytes: A group of eight bits is called a byte. Half a byte is called a nibble.

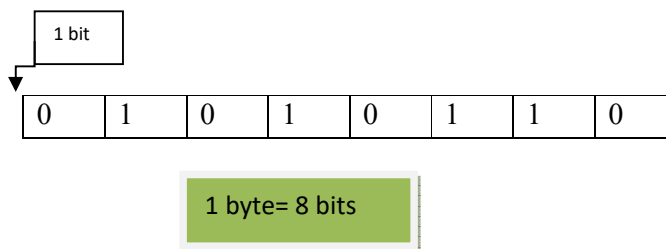

STOP TO CONSIDER

Byte Value	Bit Value
1 Byte	8 bits
1024 Bytes	1 Kilobyte
1024 kilobytes	1 Megabyte
1024 Megabytes	1 Gigabyte
1024 Gigabytes	1 Terabyte

3) **Text Code:** It is the format used commonly to represent alphabets, punctuation and other symbols. Four most popular text code systems are: a) EBCDIC, b) ASCII, c) Extended ASCII, d) Unicode

a) EBCDIC: Extended Binary Coded Decimal Interchange Code is an 8-bit code that defines 256 symbols.

b) ASCII: American Standard Code for Information Interchange is an 8-bit code that specifies character values from 0 to 127.

c) Extended ASCII: Extended American Standard Code for Information Interchange is an 8-bit code that specifies character values from 128 to 255.

d) Unicode: Unicode worldwide character standard uses 4 to 32 bits to represent letters, numbers and symbols.

CHECK YOUR PROGRESS - II

2. **State TRUE or FALSE:**

- a) Computer understands human languages.
- b) Bit is a smallest possible unit of data.
- c) 1 bits= 8 byte.
- d) 1024 Gigabytes= 1 Terabyte.
- e) EBCDIC stands for Extended Binary Coded Decimal Interchange.

Space for learners

4.2.2 Data Transmission Media and Channels

Transmission media is anything that carries information from source to destination. The way in which data is transmitted from one device to another device is known as transmission mode. Each communication channel has a direction associated with it, and transmission media provides the direction. Types of transmission mode are shown in figure 2 which are explained in the following.

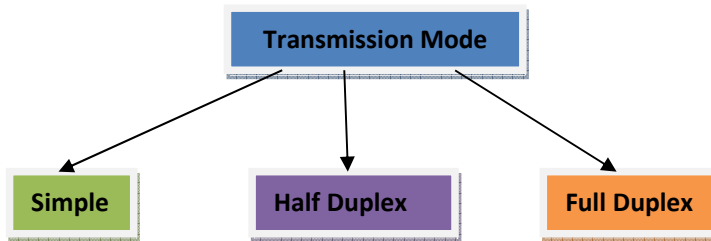

Figure 2. Types of transmission mode

1) Simplex: In a simplex transmission mode, the communication between sender and receiver occurs only in one direction. The sender can only send the data and the receiver can only receive the data. The receiver cannot reply to the sender. Simplex is like a one-way road in which the traffic travels only in one direction, no vehicle from the opposite direction is allowed to enter. For example, the keyboard can only send the input to the monitor and the monitor can only receive the input and display it on the screen. The monitor cannot reply nor send any feedback to the keyboard.

2) Half Duplex: The communication between sender and receiver occurs in both the directions in a half-duplex transmission, but one at a time. The sender and receiver both can send and receive the information, but only one is allowed to send at a time. Half duplex is still considered a one-way road, in which a vehicle travelling in the opposite direction of the traffic has to wait till the road is empty.

For example, in walkie-talkies, the speaker at both ends can speak but they have to speak one by one. Both cannot speak simultaneously.

3) Full Duplex: In a full duplex transmission mode, the communication between sender and receiver can occur

Space for learners

simultaneously. The sender and receiver can both transmit and receive at the same time. The full duplex transmission mode is like a two-way road in which traffic can flow in both directions at the same time.

For example, in a telephone, two people communicate, and both are free to speak and listen at the same time.

In data communication terminology, a transmission medium is a physical path between transmitter and the receiver.

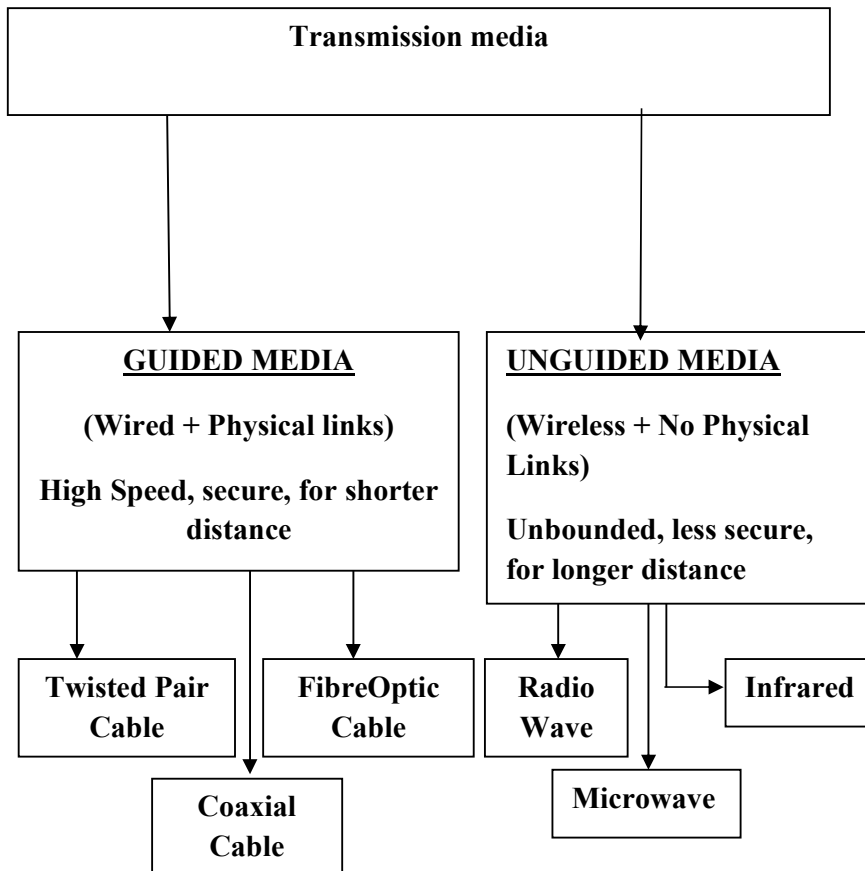

Space for learners

1. Guided Media:

a) Twisted Pair Cable: It consists of two conductors (normally copper) each with its own plastic insulation twisted together.



Figure 3. Twisted Pair Cable

One of the wires carries signal, other is in the ground, and the receiver receives the difference of the two. The wires are twisted, so that the unwanted signals (interference and crosstalk) are balanced at the receiver side. Figure 3 presents a twisted pair cable.

Twisted pair cable is of two types.

- I. **Unshielded Twisted Pair (UTP):** It is most common twisted pair cable.
- II. **Shielded Twisted Pair (STP):** In this type, extra mesh covering that improves quality is used.

Applications:

1. These are used in telephone lines to provide voice and data channels.
2. DSL lines used by telephone companies to provide high data rate use UTP.
3. LAN network, 10-Base T and 100-Base T use twisted pair cable.

b) Coaxial Cable: It carries signal of higher frequencies than in twisted pair. Coaxial cable has a central core conduction of solid or standard wire (usually copper) enclosed in insulating sheath, in turn in outer conductor of metal foil, or combination of two. Figure 4 depicts the layout of Coaxial cable.



Figure 4. Coaxial Cable

Space for learners

Attenuation is much higher in coaxial cable than twisted pair cable. Although coaxial cable has higher bandwidth, signal weakens rapidly. So, it requires frequent use of repeaters.

Application:

1. Digital Telephone Networks.
2. Cable TV Networks.

c) Fibre Optic Cable: It is made of glass or plastic and transmits signals in the form of light. A fiber optic cable is having five main components: core, cladding, coating, strengthening fibers, and cable jacket which are shown in the figure 5.

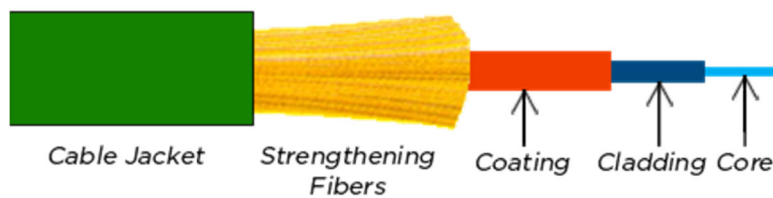

Figure 5. Structure of Fiber optic cable

STOP TO CONSIDER

- Attenuation is lesser in Fiber optic cable. So, less number of repeaters are required for Fiber optic cable than twisted pair and coaxial cables.
- Fiber optic cables are expensive.
- Higher Bandwidth.
- Less signal attenuation. Immune to noise interference.
- Light weight.
- Installation and maintenance is complex.
- Unidirectional with one optical fibre.
- Cost is huge.

2) Unguided Wireless Media: Transmission using electromagnetic waves without using a physical conductor is known as unguided wireless media. Different classes of this media along with frequency range is shown in Figure 6.

Space for learners

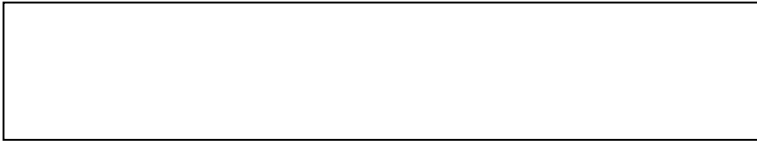

Figure 6. Unguided Wireless Media

Space for learners

a) Radio Wave:

- Omnidirectional that is, signal flows in all direction. So, receiving and transmission antennas need not be aligned.
- It can penetrate walls.
- Long distance used in AM radio.
- Applications include- multicasting, AM, FM, television, cordless phone, and paging.

b) Microwave:

- Unidirectional that is, signal flows in a single direction, thus, antennas need to be aligned.
- Very high frequency microwaves cannot penetrate walls.
- Microwave bond is wide, thus, can be sub divided and higher data rate is possible.
- Applications include unicast in cellular phones, satellite networks, wireless LANs.

c) Infrared (300 GHz-400 THz):

- It is useful for short range communication.
- They cannot penetrate walls.
- Infrared cannot be used outside a building because sunlight contains infrared waves that can interfere with communication.
- Applications include- keyboards, mouse and printers.

CHECK YOUR PROGRESS - III

3.i) State True or False in case of Fiber optic cable

- a) Easy installation and maintenance.
- b) Immune to electromagnetic interference.
- c) Less signal attenuation.
- d) Greater immunity to tapping.

ii) Choose the correct one:

- a) Loss in signal as light travels down the fibre is called? (Attenuation/ Propagation/ Scattering/ Interruption)
- b) Which type electromagnetic waves are used for unicast communication? (Infrared/ Microwaves/ Radio waves/ Light waves)

4.2.3 Transmission Impairment

When signals travel through the medium, they tend to deteriorate. Attributes to signal attenuation cover the following:

1. **Attenuation:** When the signal passes through medium, it tends to get weaker. So, as it covers distance, it loses strength.
2. **Dispersion:** When signal travels through the media, it tends to spread and overlap. It depends upon the frequency used.
3. **Delay distortion:** If the signal speed and frequency do not match, there are possibilities that it reaches destination in arbitrary fashion.
4. **Noise:** Noise in signal is basically random disturbance or fluctuation in analog or digital signal. It can be
 - I. **Thermal Noise:** It is basically happened because heat agitates conductor of a medium.
 - II. **Intermodulation:** It occurs if two different frequencies are sharing a medium and one of them has excessive strength or the component is not functioning properly.
 - III. **Crosstalk:** It happens when a foreign signal enters into the media. This is because signal in one medium affects the signal of second medium.
 - IV. **Impulse:** This noise is introduced because of irregular disturbance such as lightening, electricity, short-circuit, or faulty components. Digital data is mostly affected by this sort of noise.

4.2.4 Digital Transmission and Signal Encoding

Data can be represented in analog or digital form. Encoding is the process of converting the data or a given sequence of characters, symbols, alphabets etc, into a specified format, for the secured transmission of data. Decoding is the reverse process of encoding which is to extract the information from the converted format. Few techniques of data encoding are described in the following.

Data Encoding Techniques:

1. **Digital to digital conversion:** It is the representation of digital information by a digital signal. When binary 1s and 0s generated by the computer are translated into a sequence of voltage pulses that can be propagated over a wire, this process is known as digital-to-digital encoding. Figure 7

presents digital-to-digital encoding process. It is divided into three categories: **i) Unipolar Encoding, ii) Polar Encoding, iii) Bipolar Encoding.**



Figure 7. Digital-to-digital conversion

2. Analog to digital conversion: In this technique, the analog signal is converted into digital signal. Here, two techniques are used:

i) PAM (Pulse Amplitude Modulation), ii) PCM (Pulse Code Modulation)

3. Digital to analog method: In this case, data from one computer is sent to another via some analog carrier. It is first converted into analog signals. Analog signals are modified to reflect digital data.

Four methods are used in this case:

- I. ASK (Amplitude Shift Key).**
- II. PSK (Phase Shift Key).**
- III. FSK (Frequency Shift Key).**
- IV. QAM (Quadrature Amplitude Modulation).**

CHECK YOUR PROGRESS - IV

4. State True or False:

- a) Crosstalk is one of the reasons of transmission impairment.
- b) Unipolar encoding is the conversion method of digital to analog.
- c) Decoding is the process to extract the information from the converted format.
- d) In intermodulation, two different frequencies sharing a medium.

Space for learners

4.3 SUMMING UP

- Physical layer interacts with hardware and signalling mechanism.
- Computer represents data in three forms: number system, bits and bytes, and text code.
- Data transmission mode is mainly simple, half duplex and full duplex.
- Data transmission medium is mainly of two types that are guided media and unguided media.
- In guided media, three physical cables are used that is twisted pair cable, coaxial cable and fibre optic cable.
- In unguided media, we use radio wave, microwave and infrared.
- Transmission impairment resources are attenuation, dispersion, delay distortion and noise. Noise can be thermal, intermodulation, crosstalk and impulse.
- Data encoding techniques is mainly digital to digital conversion, analog to digital conversion and digital to analog conversion.

4.4 ANSWERS TO CHECK YOUR PROGRESS

Check Your Progress – I:

1. a) 3, b) 3

Check Your Progress – II:

2. a) False, b) True, c) False, d) True, e) True

Check Your Progress – III:

3. i) a. False b. True c. True d. True
ii) (a) Attenuation, (b) Microwave

Check Your Progress – IV:

- 4.a) True b) False c) True d) True

4.5 POSSIBLE QUESTIONS

Short type Questions:

1. Mention network devices used in physical layer.
2. What are the functions used in physical layer?
3. What are the transmission modes used in physical layer?
4. What is number system? Mention its types.
5. What is Unicode?
6. What are the resources of transmission impairment?
7. What are the data encoding techniques?

Long answer type questions:

1. Briefly explain all data representation techniques.
2. Explain all transmission modes with suitable examples.
3. What is guided media? Explain all its types.
4. What is unguided media? Explain all its types.
5. What is noise? Mention all its types.
6. Explain all transmission impairments resources.
7. Explain all data encoding techniques.
8. Write short notes on the following:
 - a) Twisted Pair Cable.
 - b) Coaxial Cable.
 - c) Fibre Optic Cable.
 - d) Radio Wave
 - e) Microwave

4.6 REFERENCES AND SUGGESTED READINGS

- Computer Network, Fourth Edition, Andrew S. Tanenbaum

Space for learners

UNIT 5: THE PHYSICAL LAYER: TRANSMISSION MEDIA

Unit Structure:

- 5.1 Introduction
- 5.2 Unit Objectives
- 5.3 Some Basic Terms & their definition
- 5.4 Classification of Transmission Media
 - 5.4.1 Guided Media
 - 5.4.2 Wireless Transmission
- 5.5 Summing Up
- 5.6 Answers to Check Your Progress
- 5.7 Possible Questions
- 5.8 References and Suggested Readings

5.1 INTRODUCTION

The physical layer defines the means of transmitting a stream of raw bits over a physical data link connecting network nodes. The bit-stream may be grouped into code words or symbols and converted to a physical signal that is transmitted over a transmission medium. The physical layer provides an electrical, mechanical, and procedural interface to the transmission medium. The shapes and properties of the electrical connectors, the frequencies to broadcast on, the line code to use and similar low-level parameters, are specified by the physical layer[1][3].

The physical layer consists of the electronic circuit transmission technologies of a network. It is a fundamental layer underlying the higher-level functions in a network, and can be implemented through a great number of different hardware technologies with widely varying characteristics.

Within the semantics of the OSI model, the physical layer translates logical communications requests from the data link layer into hardware-specific operations to cause transmission or reception of electronic (or other) signals[4][5]. The physical layer supports higher layers responsible for generation of logical data packets.

Space for learners

5.2 UNIT OBJECTIVES

After going through this unit you will be able to:

- know differ
- Transmission media is a communication channel that carries the information from the sender to the receiver. Data is transmitted through the electromagnetic signals.
- The main functionality of the transmission media is to carry the information in the form of bits through LAN(Local Area Network).
- It is a physical path between transmitter and receiver in data communication.
- In a copper-based network, the bits in the form of electrical signals.
- In a fibre based network, the bits in the form of light pulses.
- In **OSI** (Open System Interconnection) phase, transmission media supports the Layer 1. Therefore, it is considered to be as a Layer 1 component.
- The electrical signals can be sent through the copper wire, fibre optics, atmosphere, water, and vacuum.
- The characteristics and quality of data transmission are determined by the characteristics of medium and signal.
- Transmission media is of two types: wired media and wireless media. In wired media, medium characteristics are more important whereas, in wireless media, signal characteristics are more important.
- Different transmission media have different properties such as bandwidth, delay, cost and ease of installation and maintenance.

- The transmission media is available in the lowest layer of the OSI reference model, i.e., **Physical layer**.

Space for learners

5.3 SOME BASIC TERMS AND THEIR DEFINITION

- **Bandwidth:** **Bandwidth** is the data transfer capacity of a wired or wireless communications link to transmit data over a **network** connection in bits per second (Bps). The greater the bandwidth of a medium, the higher the data transmission rate of a signal [5].
- **Transmission impairment:** When the received signal is not identical to the transmitted one, it is only due to the transmission impairment. The quality of the signals will get destroyed due to transmission impairment.
- **Interference:** An interference is defined as the process of disrupting a signal when it travels over a communication medium on the addition of some unwanted signal.
- **Core:** The optical fiber consists of a narrow strand of glass or plastic known as a core. A core is a light transmission area of the fiber. The more the area of the core, the more light will be transmitted into the fiber.
- **Cladding:** The concentric layer of glass is known as cladding. The main functionality of the cladding is to provide the lower refractive index at the core interface as to cause the reflection within the core so that the light waves are transmitted through the fiber.
- **Jacket:** The protective coating consisting of plastic is known as a jacket. The main purpose of a jacket is to preserve the fiber strength, absorb shock and extra fiber protection.

5.4 CLASSIFICATION OF TRANSMISSION MEDIA

Transmission media can be broadly classified into two types namely Guided and Unguided media which are further subclassified and these are presented in Figure 1.

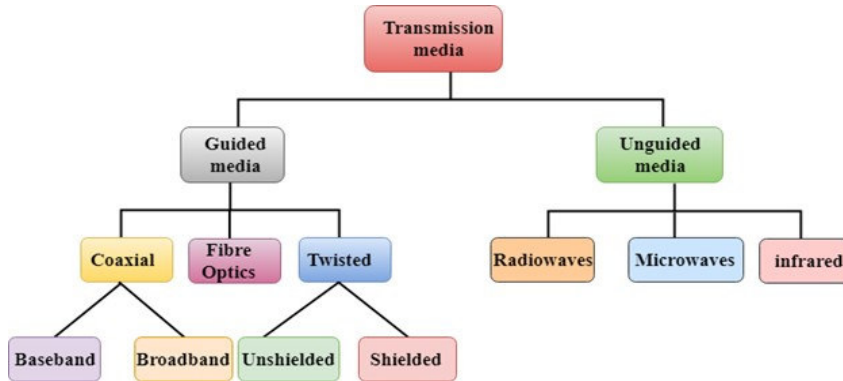

Figure 1. classification of Transmission media

5.4.1 Guided Media

It is defined as the physical medium through which the signals are transmitted. It is also known as Boundedmedia.

Types of Guided media:

5.4.1.1 Twisted Pair

The oldest and still most common transmission medium is twisted pair. A twisted pair consists of two insulated copper wires, typically about 1 mm thick [6]. The wires are twisted together in a helical form, just like a DNA molecule. The purpose of twisting the wires is to reduce electrical interference from similar pairs close by. A twisted pair cable is cheap as compared to other transmission media. Installation of the twisted pair cable is easy, and it is a lightweight cable. The frequency range for twisted pair cable is from 0 to 3.5KHz.

A twisted pair consists of two insulated copper wires arranged in a regular spiral pattern.

The degree of reduction in noise interference is determined by the number of turns per foot. Increasing the number of turns per foot decreases noise interference.

Types of Twisted pair: There are two kinds of twisted pair cable which are explained in the following.

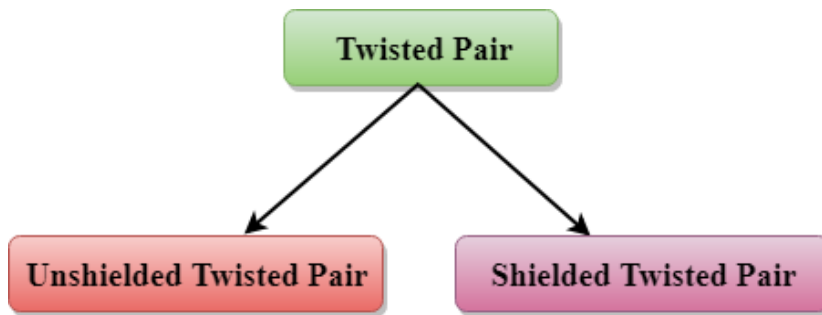

Space for learners

i) Unshielded Twisted Pair cable:

An unshielded twisted pair cable is widely used in telecommunication. Following are the categories of the unshielded twisted pair cable:

- **Category 1:** Category 1 is used for telephone lines that have low-speed data.
- **Category 2:** It can support up to 4 Mbps.
- **Category 3:** It can support up to 16 Mbps.
- **Category 4:** It can support up to 20 Mbps. Therefore, it can be used for long-distance communication.
- **Category 5:** It can support up to 200 Mbps.

Advantages of Unshielded Twisted Pair:

- It is cheap.
- Installation of the unshielded twisted pair is easy.
- It can be used for high-speed LAN.

Disadvantage:

- This cable can only be used for shorter distances because of attenuation.

ii) Shielded Twisted Pair

A shielded twisted pair is a cable that contains the mesh surrounding the wire that allows the higher transmission rate.

Characteristics of Shielded Twisted Pair:

- The cost of the shielded twisted pair cable is not very high and not very low.
- An installation of STP is easy.
- It has higher capacity as compared to unshielded twisted pair cable.
- It is shielded that provides the higher data transmission rate.

Disadvantages:

- It is more expensive as compared to UTP and coaxial cable.
- It has a higher attenuation rate.

5.4.1.1 Coaxial Cable

Another common transmission medium is the coaxial cable. It has better shielding than twisted pairs, so it can span longer distance at higher speeds. Coaxial cable is a type of transmission line, used to carry high-frequency electrical signals with low losses [7]. It is used in such applications as telephone trunk lines, broadband internet networking cables, high-speed computer databusses, cable television signals, and connecting radio transmitters and receivers to their antennas. It differs from other shielded cables because the dimensions of the cable and connectors are controlled to give a precise, constant conductor spacing, which is needed for it to function efficiently as a transmission line.

Coaxial cable is of two types:

1. **Baseband transmission:** It is defined as the process of transmitting a single signal at high speed.
2. **Broadband transmission:** It is defined as the process of transmitting multiple signals simultaneously.

Advantages Of Coaxial cable:

- The data can be transmitted at high speed.
- It has better shielding as compared to twisted pair cable.
- It provides higher bandwidth.

Space for learners

Disadvantages Of Coaxial cable:

- It is more expensive as compared to twisted pair cable.
- If any fault occurs in the cable causes the failure in the entire network.

5.4.1.3 Fiber Optic Cable

The world of telecommunications is rapidly moving from copper wire networks to fiber optics. Optical fiber is a very thin strand of pure glass which acts as a waveguide for light over long distances. It uses a principle known as total internal reflection [8]. Fiber optic cable is actually composed of two layers of glass: The core, which carries the actual light signal, and the cladding, which is a layer of glass surrounding the core. The cladding has a lower refractive index than the core. This causes Total Internal Reflection within the core. Most fibers operate in duplex pairs: one fiber is used to transmit and the other is used to receive. But it is possible to send both signals over a single strand. There are two main types of fiber optic cables: Single Mode Fiber (SMF) and Multi-Mode Fiber (MMF). The difference is basically in the size of the core. MMF has a much wider core, allowing multiple modes (or “rays”) of light to propagate. SMF has a very narrow core which allows only a single mode of light to propagate. Each type of fiber has different properties with its own advantages and disadvantages.

- Fiber optic cable uses electrical signals for communication.
- It is a cable that holds the optical fiber coated in plastic that are used to send the data by pulses of light.
- The plastic coating protects the optical fiber from heat, cold, electromagnetic interference from other types of wiring.
- Fiber optics provide faster data transmission than copper wires.

Following are the advantages of fiber optic cable over copper:

- **Greater Bandwidth:** The fiber optic cable provides more bandwidth as compared to copper. Therefore, the fiber optic carries more data as compared to copper cable.
- **Faster speed:** Fiber optic cable carries the data in the form of light. This allows the fiber optic cable to carry the signals at a higher speed.

Space for learners

- **Longer distances:** The fiberoptic cable carries the data at a longer distance as compared to copper cable.
- **Better reliability:** The fiber optic cable is more reliable than the copper cable as it is immune to any temperature changes while it can cause obstruct in the connectivity of copper cable.
- **Thinner and Sturdier:** Fiber optic cable is thinner and lighter in weight so it can withstand more pull pressure than copper cable.

5.4.2 Wireless Transmission

An unguided transmission media transmits data through the electromagnetic waves without using any physical medium. Therefore, it is also known as **wireless transmission**. In unguided media, air is the media through which the electromagnetic energy can flow easily.

Unguided transmission is broadly classified into three categories:

5.4.2.1 Electromagnetic Spectrum

The electromagnetic (EM) spectrum is the range of all types of EM radiation. Radiation is energy that travels and spreads out as it goes – the visible light that comes from a lamp in your house and the radio waves that come from a radio station, and these are two types of electromagnetic radiation. The other types of EM radiation that make up the electromagnetic spectrum are microwaves, infrared light, ultraviolet light, X-rays and gamma-rays.

5.4.2.2 Broadcast Radio Transmission

- Radio waves are the electromagnetic waves that are transmitted in all the directions of free space.
- Radio waves are Omni-directional, i.e., the signals are propagated in all the directions.
- The range in frequencies of radio waves is from 3 KHz to 1kHz.
- In the case of radio waves, the sending and receiving antenna are not aligned, i.e., the wave sent by the sending antenna can be received by any receiving antenna.
- An example of the radio wave is **FM radio**.

Space for learners

Applications Of Broadcast Radio Transmission

- A Radio wave is useful for multicasting when there is one sender and many receivers.
- An FM radio, television, cordless phones are examples of a radio wave.

Advantages Of Broadcast Radio Transmission

- Radio transmission is mainly used for wide area networks and mobile cellular phones.
- Radio waves cover a large area, and they can penetrate the walls.
- Radio transmission provides a higher transmission rate.

5.4.2.3 Infrared Transmission

- An infrared transmission is a wireless technology used for communication over short ranges.
- The frequency of the infrared in the range from 300 GHz to 400THz.
- It is used for short-range communication such as data transfer between two cell phones, TV remote operation, data transfer between a computer and cell phone resides in the same closed area.

Characteristics of Infrared:

- It supports high bandwidth, and hence the data rate will be very high.
- Infrared waves cannot penetrate the walls. Therefore, the infrared communication in one room cannot be interrupted by the nearby rooms.
- An infrared communication provides better security with minimum interference.
- Infrared communication is unreliable outside the building because the sun rays will interfere with the infrared waves.

5.4.2.4 Microwave Transmission

Microwaves are widely used point to point communications because their small wavelength allows conveniently-sized antennas to direct them in narrow beams, which can be pointed directly at the receiving antenna. This allows nearby microwave equipment to use the same frequencies without interfering with each other, as lower frequency radio waves do. This frequency reuse conserves scarce radio spectrum bandwidth. Another advantage is that the high frequency of microwaves gives the microwave band a very large information-carrying capacity; the microwave band has a bandwidth 30 times that of all the rest of the radio spectrum below it. A disadvantage is that microwaves are limited to line of sight propagation; they cannot pass around hills or mountains as lower frequency radio wave scan pass [4].

Microwave radio transmission is commonly used in point-to-point communication systems on the surface of the Earth, in satellite communications, and in deep space radiocommunications. Other parts of the microwave radio band are used for radars, radionavigation systems, sensor systems, and radioastronomy.

Microwaves are of two types:

- Terrestrial microwave
- Satellite microwave communication.

5.4.2.5 Terrestrial Microwave Transmission

- Terrestrial Microwave transmission is a technology that transmits the focused beam of a radio signal from one ground-based microwave transmission antenna to another.
- Microwaves are the electromagnetic waves having the frequency in the range from 1GHz to 1000GHz.
- Microwaves are unidirectional as the sending and receiving antenna is to be aligned, i.e., the waves sent by the sending antenna are narrowly focused.
- In this case, antennas are mounted on the towers to send a beam to another antenna which is km away.
- It works on the line of sight transmission, i.e., the antennas mounted on the towers are the direct sight of each other.

Characteristics of Microwave:

- **Frequency range:** The frequency range of terrestrial microwave is from 4-6 GHz to 21- 23GHz.
- **Bandwidth:** It supports the bandwidth from 1 to 10Mbps.
- **Short distance:** It is inexpensive for short distance.
- **Long distance:** It is expensive as it requires a higher tower for a longer distance.
- **Attenuation:** Attenuation means loss of signal. It is affected by environmental conditions and antenna size.

Advantages:

- Microwave transmission is cheaper than using cables.
- It is free from land acquisition as it does not require any land for the installation of cables.
- Microwave transmission provides an easy communication in terrains as the installation of cable in terrain is quite a difficult task.
- Communication over oceans can be achieved by using microwave transmission.

Disadvantages:

- **Eavesdropping:** An eavesdropping creates insecure communication. Any malicious user can catch the signal in the air by using its own antenna.
- **Out of phase signal:** A signal can be moved out of phase by using microwave transmission.
- **Susceptible to weather condition:** A microwave transmission is susceptible to weather condition. This means that any environmental change such as rain, wind can distort the signal.
- **Bandwidth limited:** Allocation of bandwidth is limited in the case of microwave transmission.

5.4.2.6 Satellite Microwave Transmission

- A satellite is a physical object that revolves around the earth at a known height.
- Satellite communication is more reliable nowadays as it offers

- more flexibility than cable and fiber optic systems.
- We can communicate with any point on the globe by using satellite communication.

Advantages:

- The coverage area of a satellite microwave is more than the terrestrial microwave.
- The transmission cost of the satellite is independent of the distance from the center of the coverage area.
- Satellite communication is used in mobile and wireless communication applications.
- It is easy to install.
- It is used in a wide variety of applications such as weather forecasting, radio/TV signal broadcasting, mobile communication, etc.

Disadvantages:

- Satellite designing and development requires more time and higher cost.
- The Satellite needs to be monitored and controlled on regular periods so that it remains in orbit.
- The life of the satellite is about 12-15 years. Due to this reason, another launch of the satellite has to be planned before it becomes non-functional.

Space for learners

CHECK YOUR PROGRESS

1. A transmission medium is located under and controlled by the
 - a) Transport layer
 - b) Physical layer
 - c) application layer
 - d) session layer
2. Guided transmission media include
 - a) Coaxial cable
 - b) Fiberoptic cable
 - c) twisted pair cable
 - d) All of the above
3. Which of the following is not a type of twisted pair cable?
 - a) UTP
 - b) FTP
 - c) STP
 - d) None of the above

Space for learners

4. BNC connectors are used with
 - a) Satellite
 - b) Fiberoptic cable
 - c) Coaxial cable
 - d) twisted pair cable

5. The transmission medium with maximum error rate is
 - a) Coaxial cable
 - b) Twisted pair cable
 - c) satellite link
 - d) optical fiber

6. Optical fibers transmit a beam of light by means of
 - a) Total internal reflection
 - b) Total internal refraction
 - c) Both a) &b)
 - d) None of these

7. In multimode step-index fibre, the density of the core -----
----- from the center to the edges.
 - a) Increases
 - b) Decreases
 - c) remain constant
 - d) none of these

8. Which of the following is not a band?
 - a) VHF
 - b) UHF
 - c) VLF
 - d) SLF

9. Unguided signals can propagate in-----
 - a) Two
 - b) Three
 - c) eight
 - d) four

10. The frequency at which a signal is received by a satellite is
known as its-----frequency
 - a) Downlink
 - b) Microwave
 - c) terrestrial
 - d) uplink Answer to

5.5 SUMMING UP

- Transmission media can be broadly classified into two types namely Guided and Unguided media.
- The oldest and still most common transmission medium is twisted pair. A twisted pair consists of two insulated copper wires arranged in a regular spiral pattern. The degree of reduction in noise interference is determined by the number of

turns per foot. Increasing the number of turns per foot decreases noise interference

- In wireless transmission, an unguided transmission media transmits data through the electromagnetic waves without using any physical medium.
- Microwave radio transmission is commonly used in point-to-point communication systems on the surface of the Earth, in satellite communications, and in deep space radio communications.

5.6 ANSWERS TO CHECK YOUR PROGRESS

1. (b)
2. (d)
3. (b)
4. (c)
5. (b)
6. (a)
7. (c)
8. (d)
9. (b)
10. (d)

5.7 POSSIBLE QUESTIONS

- i) What are transmission media? What are the different categories of transmission media?
- ii) Differentiate guided and unguided transmission media.
- iii) Explain in details the various types of guided transmission media.
- iv) Why twisting of wires is necessary in twisted pair cable?
- v) Write advantage and disadvantages of twisted pair cable and fiber optic cable.
- vi) What are the different fiber sizes and connectors available?
- vii) Explain the use of electromagnetic spectrum for communication.

Space for learners

vii) Explain the different propagation methods for unguided signals.

viii) Explain in details the different un guided media.

Space for learners

5.8 REFERENCES AND SUGGESTED READINGS

1. Gorry Fairhurst (2001-01-01)."Physical Layer". Archived from the original on 2009- 06-18.
2. Iyengar, Shisharama (2010).Fundamentals of Sensor Network Programming. Wiley. p. 136.ISBN978-1423902454.
3. "The Physical Layer | InterWorks". InterWorks. 2011-07-30. Retrieved2018-08-14.
4. Shaw, Keith (2018-10-22)."The OSI model explained: How to understand (and remember) the 7 layer network model". Network World. Retrieved2019-02-15.
5. "DATA COMMUNICATION & NETWORKING". ResearchGate. Retrieved2019-02-15.
6. This article incorporates public domain material from the General Services Administration document: "Federal Standard1037C".
7. "physical signaling sublayer (PLS)". Archived from the original on 2010-12-27. Retrieved2011-07-29.
8. "rfc1122". datatracker.ietf.org. Retrieved2021-07-28.

UNIT 6: THE PHYSICAL LAYER: TRANSMISSION MODES

Space for learners

Unit Structure:

- 6.1 Introduction
- 6.2 Unit Objectives
- 6.3 Physical Layer: An Introduction
- 6.4 Asynchronous Transmission
- 6.5 Synchronous Transmission
- 6.6 Baseband Transmission
- 6.7 Broadband Transmission
- 6.8 Modulation Methods
- 6.9 Modems
- 6.10 Multiplexing
- 6.11 Summing up
- 6.12 Answers to Check Your Progress
- 6.13 Possible Questions
- 6.14 References and Suggested Readings

6.1 INTRODUCTION

The Physical Layer defines the physical and electrical characteristics of the network. It acts as a conduit between computers' networking hardware and their networking software. It handles the transfer of bits (0s and 1s) from one computer to another. This is where the bits are actually converted into electrical signals that travel across the physical circuit. Physical Layer communication media include various types of copper or fibre-optic cable, as well as different wireless media.

6.2 UNIT OBJECTIVES

After going through this unit, you will be able to:

- Understand the asynchronous, synchronous, baseband and broadband transmission.
- Understand different modulation methods.
- Know working of modems
- Understand the different multiplexing techniques used for transmitting signals.

6.3 PHYSICAL LAYER: AN INTRODUCTION

The Physical Layer is concerned with sending raw bits between the source and destination nodes, which, in this case, are adjacent nodes. To this, the source and the destination nodes have to agree on a number of factors, such as, what voltage constitutes a bit value 0, what voltage constitutes bit values 1, what is the bit interval (i.e. the bit rate), whether the communication is in only one or both the directions simultaneously (i.e. simplex, half duplex or full duplex, and so on). It also deals with the electrical and mechanical specifications of the cables, connectors, and interfaces such as RS 232-C, etc. [1].

The Physical Layer in TCP/ IP is not different in any way to the physical layer of the OSI model. This layer deals with the hardware level, voltage, etc. and there is nothing significantly different in TCP/ IP. Figure 6.1 presents physical layer transmission.

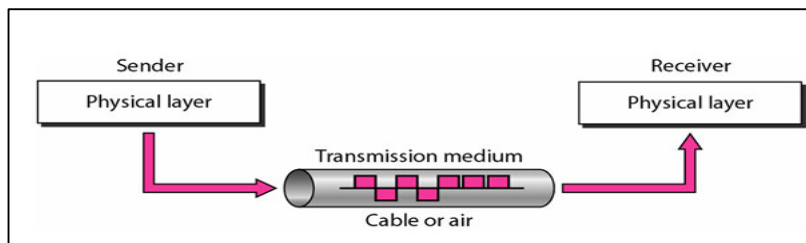

Space for learners

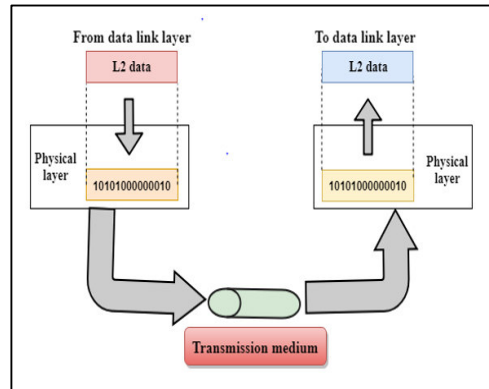

Fig 6.1: Physical Layer Transmission (Source: Internet)

Transmission media refers to the media through which data can be carried from a source to a destination. Data is transmitted from one device to another through electromagnetic signals. Transmission media are located under and controlled by the physical layer as discussed below.

The different categories of transmission media include **guided or wired** and **unguided or wireless** media.

a) Guided transmission media uses a cabling system that guides the data signals along a specific path. It consists of cable composed of metals such as copper, tin or silver. The data signal in guided medium is bounded by the cabling system; hence, the guided medium is also known as **Bounded medium**. There are three basic types of guided transmission media:

- i) Twisted-pair cable
- ii) Coaxial cable
- iii) Fibre-optic cable

b) Unguided transmission media facilitates data transmission without the use of a physical conduit. The electromagnetic signals are transmitted through earth's atmosphere (air, water or vacuum) at

Space for learners

a much faster rate covering a wide area. The electromagnetic waves are not guided or bounded to a fixed channel to follow. There are basically four types of unguided transmission media including:

- i) Radio waves
- ii) Microwaves
- iii) Satellite transmission
- iv) Infrared waves

Transmission Modes in Computer Networks: There are 3 types of transmission modes which are given below: Simplex mode, Half duplex mode, and Full duplex mode. These are explained in the following.

a) Simplex mode:

In simplex mode, Sender can send the data but that sender can't receive the data. It is a unidirectional communication as shown in figure 6.2.

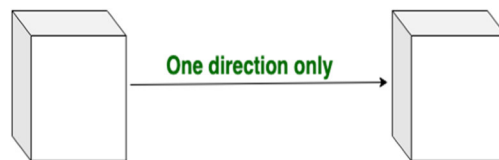

Fig 6.2: Simplex Mode (Source: Internet)

b) Half-duplex mode:

In half duplex mode as shown in figure 6.3, Sender can send the data and also can receive the data but one at a time. It is two-way directional communication but one at a time.

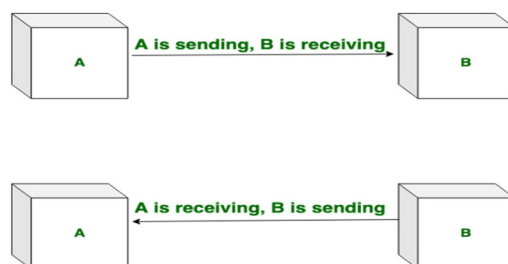

Fig 6.3: Half- duplex Mode (Source: Internet)

(c) Full duplex mode:

In full duplex mode, Sender can send the data and also can receive the data simultaneously. It is two-way directional communication simultaneously. Figure 6.4 presents full-duplex mode.

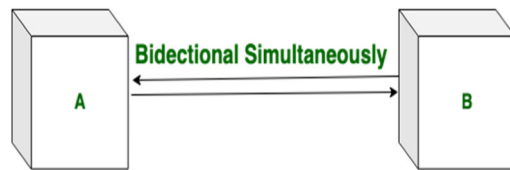

Fig 6.4: full- duplex Mode (Source: Internet)

6.4 ASYNCHRONOUS TRANSMISSION:

In **Asynchronous transmission**, the entire bit stream is divided into groups of 8 bits (i.e., one byte) each. Each byte is treated independently and transmitted whenever ready regardless of the timer. To let the receiver know about the arrival of a byte, a start bit (usually represented by 0) is added to the starting of each byte. Similarly, one or more stop bits (usually represented by 1) are added to indicate the end of each byte. Though the transmission is asynchronous at the byte level, still some synchronization is needed during the transmission of bits within a byte. To achieve this synchronization, the receiver starts the timer after finding the start bit and counts the number of bits until it finds the stop bit. There may be gap between the transmission of two bytes which is filled with a series of stop bits or idle channel. Asynchronous transmission is slow as it adds control information such as start bits, stop bits, and gap between bytes. However, it is a cheaper and effective mode of transmission and thus is suitable for communication between

Space for learners

devices which do not demand fast speed [2]. Figure 6.5 depicts Asynchronous transmission.

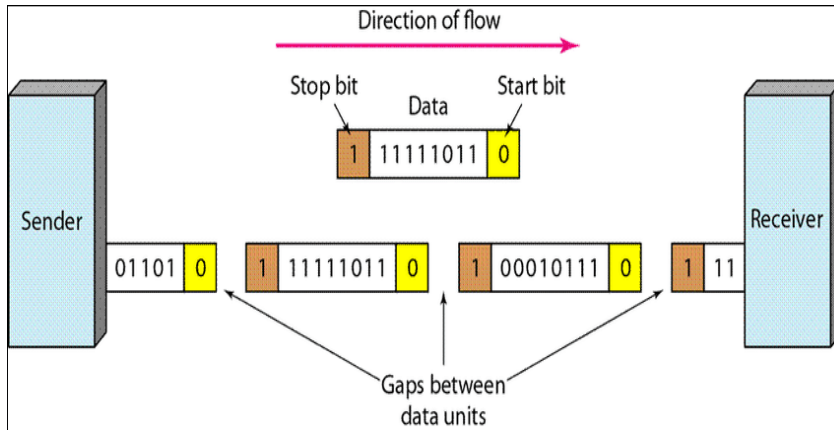

Fig 6.5: Asynchronous transmission (Source: Internet)

6.5 SYNCHRONOUS TRANSMISSION

In Synchronous transmission as presented in figure 6.6, timing source is used for synchronization, so that the receiver can receive the information in the order in which it is sent. Multiple bytes are combined together to form frames. Data is transmitted as a continuous sequence of 1s and 0s with no gap in between. However, if there is any gap, that gap is filled with a special sequence of 0s and 1s called idle. At the receiver's end, the receiver keeps counting the bit and separates them into byte groups for decoding. Synchronous transmission is fast as compared to asynchronous transmission, as it does not use any extra bits such as start bits and stop bits. Thus it is best suitable for applications requiring high speed. However, this transmission cannot be used for real-time applications such as television broadcasting, as there can be uneven delays between the arrivals of adjacent frames at the receiver's end which in turn results in poor quality of video [1].

Space for learners

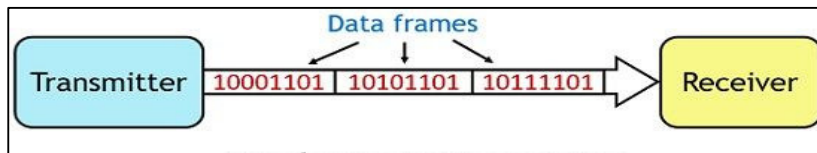

Fig 6.6: Synchronous transmission (Source: Internet)

6.6 BASEBAND TRANSMISSION

When the signal is transmitted over the channel, without any modulation, it is called baseband transmission. One major problem occurred in baseband transmission is inter symbol interface.

Baseband transmission is the simplest form for the communication of information. It is shown in figure 6.7. Discrete information is communicated with specific symbols selected from a finite set of symbols. In baseband transmission, symbols are simply communicated as a pulse with a discrete voltage level and, for binary transmission, only two voltages are used.

In this transmission, the digital signal is sent over a channel without converting it into an analog signal. The entire bandwidth of the cable is consumed by a single signal. It requires a low- pass channel i.e. a channel whose bandwidth starts from zero.

Some features of Baseband transmission are –

- Digital signaling.
- Frequency division multiplexing is not possible.
- Baseband is bi-directional transmission.
- Short distance signal travelling.
- Entire bandwidth is for single signal transmission.

Example: Ethernet is using Basebands for LAN.

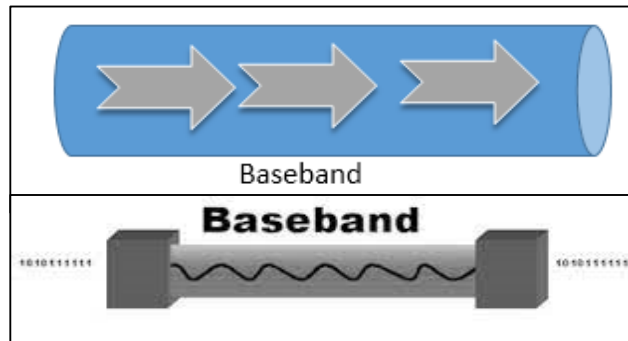

Fig 6.7: Baseband transmission (Source: Internet)

Space for learners

6.7 BROADBAND TRANSMISSION:

In Broadband transmission as depicted in figure 6.8, the digital signal is first converted into analog signal and then sent over the channel. Signals are sent on multiple frequencies, allowing multiple signals to be sent simultaneously. It requires a bandpass control i.e. a channel whose bandwidth does not start from zero.

Some features of Broadband transmission are –

- Analog signaling.
- Transmission of data is unidirectional.
- Signal travelling distance is long.
- Frequency division multiplexing is possible.
- Simultaneous transmission of multiple signals present over different frequencies.

Example: Used to transmit cable TV to premises.

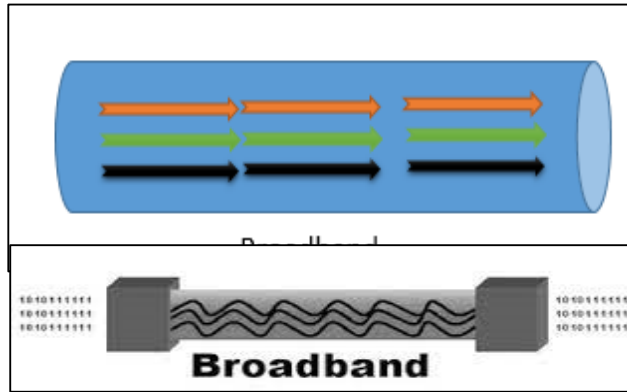

Fig 6.8: Broadband Transmission (Source: Internet)

Key differences between baseband and broadband transmissions:

Baseband transmission	Broadband transmission
Transmit digital signals	Transmit analog signals
To boost signal strength, use repeaters	To boost signal strength, use amplifiers
Can transmit only a single data stream at a time	Can transmit multiple signal waves at a time
Support bidirectional communication simultaneously	Support unidirectional communication only
Support TDM based multiplexing	Support FDM based multiplexing
Use coaxial, twisted-pair, and fiber-optic cables	Use radio waves, coaxial cables, and fiber optic cables
Mainly used in Ethernet LAN networks	Mainly used in cable and telephone networks

6.8 MODULATION METHODS

The process of changing one or more of the attributes of analog signal based on information in digital data is referred to as digital-to-analog conversion. It is also called the modulation of a digital signal. Modulation uses a coding scheme or a convention. This coding can be achieved using the three properties of a signal viz. Amplitude, Frequency and Phase. Depending upon the technique

Space for learners

used, it is called Amplitude Shift Keying (ASK), Frequency Shift Keying (FSK) or Phase Shift Keying (PSK). In all these techniques, a carrier signal with given amplitude, frequency and phase are employed, and then choose a form of encoding. Another variation of the basic modulation technique is the Quadrature Amplitude Modulation (QAM), which involves changing of both amplitude and phase of the carrier signal.

6.8.1 Amplitude Shift Keying (ASK)

ASK involves changing the amplitude of the carrier signal without changing its frequency and phase as presented in figure 6.9. The amplitude of a carrier signal is multiplied by binary 0 or 1. A special case of ASK is binary ASK (BASK), also known as on-off keying (OOK), where peak amplitude for one binary digit is taken as 0 while the other binary digit has amplitude equal to the peak amplitude of carrier frequency. Another variation of ASK is the multilevel ASK (MASK) which involves more than two levels of amplitude.

The bandwidth (B) for ASK is directly proportional to signal rate (S) as:

$$B = (1 + f_c) \times S \quad (1)$$

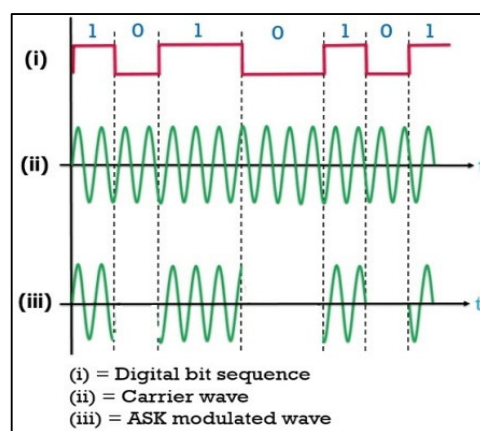

Fig 6.9: Amplitude Shift Keying (ASK) (Source: Internet)

Here, f_c is the factor whose value lies between 0 and 1 and it depends on the modulation and filtering process. It is clear from the above formula (1) that $B_{min} = S$ (when $f_c = 0$) and $B_{max} = 2 \times S$ (when $f_c = 1$).

Though ASK is the simplest technique, it is highly susceptible to noise and thus is an inefficient modulation technique.

6.8.2 Frequency Shift Keying (FSK)

In FSK technique, the frequency of the carrier signal is changed without changing its amplitude and phase. The simplest form of FSK is binary FSK (BFSK) in which two different frequencies (say f_1 and f_2) close to the carrier frequency are taken to represent two binary values in digital data. Figure 6.10 presents FSK.

The bandwidth for BFSK is calculated by the following given formula:

$$B = (1 + f_c) \times S + (f_1 - f_2), \quad (2)$$

where, $(f_1 - f_2) = 2\Delta f$

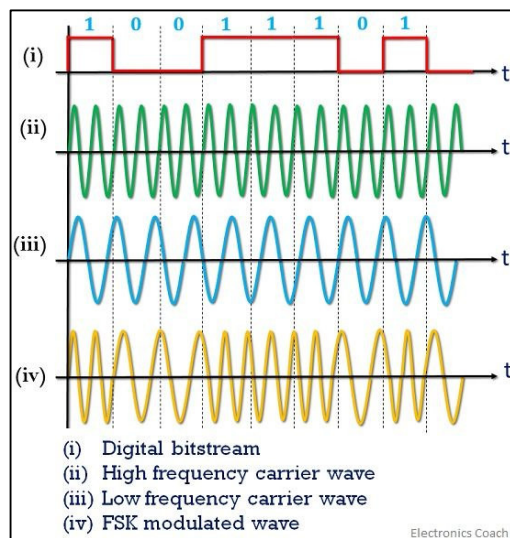

Fig 6.10: Frequency Shift Keying (FSK) (Source: Internet)

Another variation of FSK is multilevel FSK (MFSK) which involves using more than two carrier frequencies. For example, four frequencies can be used to transmit two bits, eight frequencies to transmit three bits and so on. The only requirement is that the distance between any two carrier frequencies should be $2\Delta f$. FSK is less susceptible to noise than ASK and thus is suitable for high-frequency radio transmission.

Space for learners

6.8.3 Phase Shift Keying (PSK)

In this technique, the phase of the carrier signal is changed without changing its amplitude and frequency. There are two forms of PSK techniques; namely, Binary PSK (BPKS) and Quadrature PSK (QPSK).

BPSK, also called two-level PSK, uses two phase values. To represent one binary value, the signal is sent with the same phase as that of its predecessor and to represent another binary value, the signal is sent with opposite phase from its predecessor. The bandwidth of BPSK is equal to BASK, but less than that of BFSK.

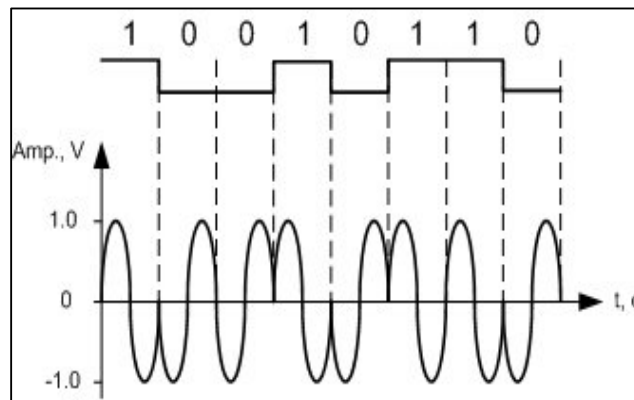

Fig 6.11: Phase Shift Keying (PSK) (Source: Internet)

QPSK, also called four-level PSK, offers an efficient use of bandwidth by using two bits at a time in each signal element. It is so called, because it involves two BPSK modulations of which one is in-phase and another is out-of-phase (quadrature). In this technique, the stream of bits is first passed through a converter which converts serial transmission into parallel transmission and then, one bit is transmitted to in-phase modulator and other bit is transmitted to out-of-phase modulator. Both modulators produce composite signals which have the same frequency but different phases. When these signals are combined, the resultant signals may involve one of four different phases: 45° , -45° , 135° , -135° .

PSK is more commonly used than ASK and FSK. It is less susceptible to noise than ASK as phase is not likely to be affected easily by the noise. Moreover, it does not require two carriers as required in FSK. PSK is depicted in figure 6.11.

6.9 MODEMS

The word **Modem** is an acronym for **modulator-demodulator**. The modulator converts digital data into analog signals i.e., **modulation** and the demodulator convert the analog signal back into digital data i.e., **demodulation** converts the analog signal back into digital data i.e., **demodulation**.

It is a hardware component that allows a computer or another device, such as a router or switch, to connect to the Internet. It converts or "modulates" an analog signal from a telephone or cable wire to digital data (1s and 0s) that a computer can recognize. Similarly, it converts digital data from a computer or other device into an analog signal that can be sent over standard telephone lines. The first modems were "dial-up," meaning they had to dial a phone number to connect to an ISP. These modems operated over standard

analog phone lines and used the same frequencies as telephone calls, which limited their maximum data transfer rate to 56 Kbps. Dial-up modems also required full use of the local telephone line, meaning voice calls would interrupt the Internet connection. The concept of Modem is shown in figure 6.12.

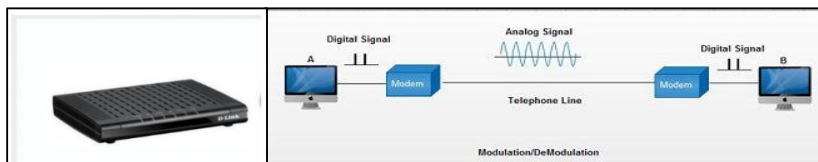

Fig 6.12: Modem, Modulation and Demodulation (Source: Internet)

6.10 MULTIPLEXING

Multiplexing is a technique used for transmitting several signals simultaneously over a single communication link. An analogy of multiplexing can be made with a multilane highway. Just as a multilane highway can carry increased volumes of traffic in multiple lanes at higher speeds and at relatively low incremental cost per lane, the higher-capacity circuit can carry multiple conversations in multiple channels at relatively low incremental cost per channel. Multiplexing is done to utilize the available bandwidth properly and to improve the efficiency during a transmission. In a multiplexed system several devices share a communication link called common medium. Each part of the communication link being used for carrying transmission between an individual pair of input and an output line is referred to as a channel.

At the sender's end, the N input lines are combined into a single stream by a communication device, called multiplexer (MUX). At the receiver's end, another communication device, called demultiplexer (DEMUX), completes the communication process by separating multiplexed signals from a communication link and distributing them to corresponding N output lines.

Multiplexing can be used in situations where the signals to be transmitted through the transmission medium have lower bandwidth than that of the medium. This is because in such situations, it is possible to combine the several low-bandwidth signals and transmitting them simultaneously through the transmission medium of larger bandwidth [2].

Multiplexing is required in a communication channel because of the following reasons:

- To send several signals simultaneously over a single communication channel.
- To reduce the cost of transmission.
- To effectively utilize the available bandwidth of the communication channel.

Multiplexing can be done using three techniques frequency-division multiplexing (FDM), wavelength-division multiplexing (WDM) and time-division multiplexing (TDM).

6.10.1 Frequency Division Multiplexing

FDM is used when the bandwidth of the transmission medium is greater than the total bandwidth requirement of the signals to be transmitted. It is often used for baseband analog signals. At the sender's end, the signals generated by each sending device are of similar frequency range within the multiplexer, these similar signals modulate carrier waves of different frequencies and then the modulated signals are merged into a single composite signal, which is sent over the transmission medium. The carries frequencies are kept well separated by assigning a different range of bandwidth (channel) that is sufficient to hold the modulated signal. There may also be some unused bandwidth between successive channels called guard bands, in order to avoid interference of signals between those channels. FDM is shown in figure 6.13.

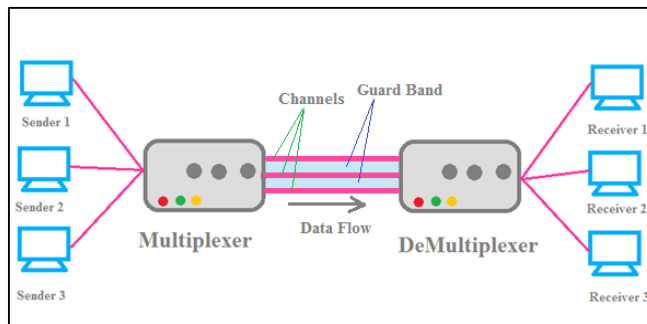

Fig 6.13: Frequency Division Multiplexing (Source: Internet)

At the receiver's end, the multiplexed signal is applied to a series of band pass filters which breaks it into component signals. These component signals are then passed to a demodulator that separates the signals from their carriers and distributes them to different output lines.

Though FDM is an analog multiplexing technique, it can also be used to multiplex the digital signals. However, before multiplexing, the digital signals must be converted to analog signals. Some common applications of FDM include radio broadcasting and TV networks.

6.10.2 Wavelength Division Multiplexing

Wavelength Division Multiplexing (WDM) is an analog multiplexing technique designed to utilize the high data rate capability of fibre-optic cables. A fibre-optic cable has a much higher data rate than coaxial and twisted-pair cables and using it as a single link wastes a lot of precious bandwidth. Using WDM as shown in figure 6.14, we merge many signals into a single one and hence, utilize the available bandwidth efficiently. Conceptually, FDM and WDM are same: that is, both combine several signals of different frequencies into one, but the major difference is that the

latter involves fibre-optic cables and optical signals as well as the signals are of very high frequency.

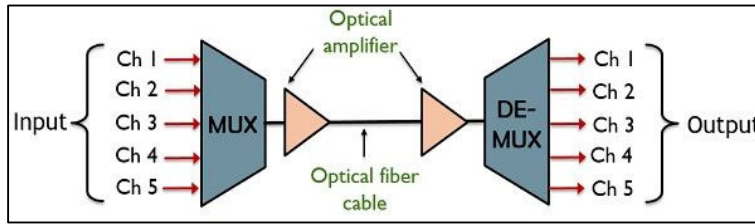

Fig 6.14: Wavelength Division Multiplexing (Source: Internet)

In WDM, the multiplexing and demultiplexing are done with the help of a prism, which bends the light beams by different amounts depending on their angle of incidence and wavelength. The prism used at the sender's end combines the multiple light beams with narrow frequency bands from different sources to form a single wider band of light which is then passed through fibre-optic cable. At the receiver's end, the prism splits the composite signal into individual signals. An application of WDM is the SONET network.

6.10.3 Time Division Multiplexing

Time Division Multiplexing (TDM) is a digital multiplexing technique that allows the high bandwidth of a link to be shared amongst several signals. Unlike FDM and WDM, in which signals operate at the same time but with different frequencies, in TDM, signals operate at the same frequency but at different times. In other words, the link is time-shared instead of sharing parts of bandwidth among several signals.

At the sender's end, the time-division multiplexer allocates each input signal a period of time or time slot. Each sending device is assigned the transmission path for a predefined time slot. Three sending signals, Signals 1, 2 and 3, occupy the transmission sequentially. As shown in the figure, time slots A, B, P, Q, X and Y

Space for learners

follow one after the other to carry signals from the three sources, which upon reaching the demultiplexer, are sent to the intended receiver. Though TDM is a digital multiplexing technique, it can also multiplex analog signals. However, before multiplexing, analog signals must be converted to digital signals. Figure 6.15 presents TDM.

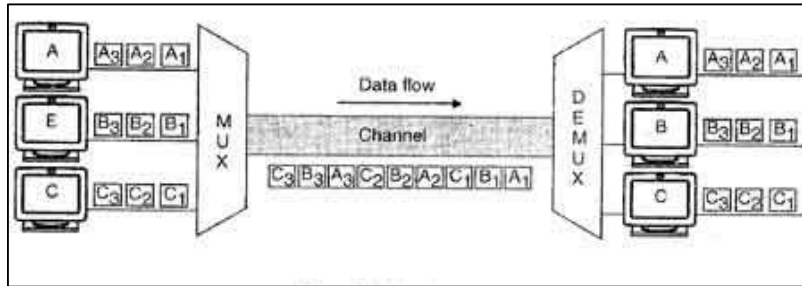

Fig 6.15: Time Division Multiplexing (Source: Internet)

6.11 SUMMING UP

- The Physical Layer defines the physical and electrical characteristics of the network. It acts as a conduit between computers' networking hardware and their networking software.
- There are three types of transmission modes present in computer networks, viz. **Simplex**, **Half Duplex**, **Full Duplex**.
- The different categories of transmission media include **guided or wired** and **unguided or wireless** media.
- **Guided transmission media** use a cabling system that guides the data signals along a specific path.
- **Unguided transmission media** facilitate data transmission without the use of a physical conduit.
- When the signal is transmitted over the channel, without any modulation, it is called **baseband transmission**.
- In **Broadband transmission** the digital signal is first converted into analog signal and then sent over the channel.
- The process of changing one or more of the attributes of analog signal based on information in digital data is referred

to as digital- to- analog conversion. It is also called the modulation of a digital signal.

- Multiplexing can be done using three techniques frequency-division multiplexing (FDM), wavelength-division multiplexing (WDM) and time-division multiplexing (TDM).
- The word **Modem** is an acronym for **modulator-demodulator**.
- The modulator converts digital data into analog signals i.e. **modulation** and the demodulator converts the analog signal back into digital data i.e. **demodulation** converts the analog signal back into digital data i.e. **demodulation**.

Space for learners

CHECK YOUR PROGRESS

Choose the correct answer:

1. Amplitude modulation is a technique used for

- [A] Analog-to- digital conversion
- [B] Digital-to-analog conversion
- [C] Analog-to-analog conversion
- [D] Digital-to-digital conversion

2. Which of the following factors of a carrier frequency is varied in QAM?

- [A] Frequency
- [B] Amplitude
- [C] Phase
- [D] Both [B] and [C]

3. A device that combines n input lines into a single stream is known as:

- [A] Demultiplexer
- [B] Serial to parallel convertor
- [C] Prism
- [D] Multiplexer

4. Multiplexing can be used in situations where the signals to be transmitted through the transmission medium have _____ bandwidth than that of the medium.

- [A] Higher
- [B] Lower
- [C] Equal
- [D] None of these

5. Which of the following multiplexing techniques involves signals composed of light beams?

- [A] FDM
- [B] TDM
- [C] WDM
- [D] None of these

Space for learners

6.12 ANSWERS TO CHECK YOUR PROGRESS

1. [C] 2. [D] 3. [D] 4. [B] 5. [C]

6.13 POSSIBLE QUESTIONS

1. Explain the different transmission techniques used in Physical Layer.
2. Explain the different multiplexing techniques.
3. What do you mean by Modem?
4. Briefly explain the different modulation methods used in Physical Layer.
5. Differentiate between Simplex, Half duplex and Full Duplex Transmission Modes.

6.14 REFERENCES AND SUGGESTED READINGS

- [1] “Data Communication and Networks”, Achyut S. Godbole.
- [2] “Computer Networks” by Andrew S. Tanenbaum

**BLOCK II:
THE DATA LINK LAYER, LAN,
WIRELESS LAN**

UNIT 1: THE DATA LINK LAYER: DESIGN ISSUES

Space for learners

Unit Structure:

- 1.1 Introduction
- 1.2 Unit Objectives
- 1.3 Services provided by Data Link Layer
 - 1.3.1 Unacknowledged Connectionless Service
 - 1.3.2 Acknowledged Connectionless Service
 - 1.3.3 Acknowledged Connection-Oriented Service
- 1.4 Framing in data link layer
 - 1.4.1 Framing Methods
- 1.5 Error Control
- 1.6 Flow Control
- 1.7 Error Detection and Correction
 - 1.7.1 Error-Detection Codes
 - 1.7.2 Error-Correction Techniques
- 1.8 Summing Up
- 1.9 Answers to Check Your Progress
- 1.10 Possible Questions
- 1.11 References and Suggested Readings

1.1 INTRODUCTION

In this unit, you will learn the design principles and the basic role of layer 2, the data link layer. This study deals with the techniques, algorithm and method for efficient and reliable communication between the two machines at data link layer. You will also learn the basic functions, services provided by the data link layer to its upper layer in OSI Reference Model. Framing is a major function of data link layer and by using framing, bit stream received from physical layer is divided into some frames. And the frame is forwarded to its upper layer. The data link layer is basically responsible for error control, flow control, error detection and

correction mechanism. For flow control and error control, data link layer uses various mechanisms which are explained below in details.

Space for learners

1.2 UNIT OBJECTIVES

After going through this unit, you will be able to:

- Understand the functionalities of data link layer.
- Know different services provided by data link layer to its upper layer.
- Understand framing and the various framing methods.
- Learn error control and different error control mechanisms.
- Acquire the process of flow control and different flow control mechanisms.
- Understand error detection and error correction techniques.

1.3 SERVICES PROVIDED BY DATA LINK LAYER

The important and essential function of Data Link Layer is to provide an interface to Network Layer. Network Layer is the third layer of seven-layer OSI reference model and it is present just above Data Link Layer. The main aim of Data Link Layer is to transmit data frames they have received to destination machine so that these data frames can be handed over to network layer of destination machine. At the network layer, these data frames are basically addressed and routed.

The Data link layer basically provides or offers three types of services as mentioned below.

- a. Unacknowledged Connectionless Service
- b. Acknowledged Connectionless Service
- c. Acknowledged Connection-Oriented Service

1.3.1 Unacknowledged Connectionless Service

Unacknowledged connectionless service basically provides datagram modes delivery without any error, issue, or flow control.

In this service, the sender host transmits independent frames to the receiver host without having the acknowledge frames from the receiver machine. This service is called as connectionless service because there is no connection established among sending or source machine and destination or receiving machine before transferring of data or after releasing the data transfer. In Data Link Layer, due to some reasons like noise, if frame is lost, no attempt will be made to determine or sense the loss of the frames or recovery of the frames. This basically means that there will not be any possibility of error or no need of any flow control mechanism. A good example of this service is the Ethernet service.

Space for learners

1.3.2 Acknowledged Connectionless Service

This service basically provides acknowledged connectionless service and here delivery of packet is merely acknowledged, with the help of stop and wait protocol. In this service, each data frame which is transmitted by the Data Link Layer is merely acknowledged separately and then sending host generally knows whether the transmitted data frames are received without any error or not. No logical connection is established between the source and destination host and each frame that is transmitted is acknowledged individually.

This mode basically provides a way by which a user of data link can simply transmit data and ask for return of data at the same time. It also uses specific time duration and if it has passed frame without getting acknowledgment, then it will retransmit the data frame on the specific time duration.

This service is considered more reliable than the unacknowledged connectionless service. This service is basically useful for different unreliable channels, such as wireless connections, wireless LAN, WiFi etc.

1.3.3 Acknowledged Connection-Oriented Service

In this Acknowledged Connection-Oriented Service, first connection is established between the source machine (sender) and

the destination machine (receiver) before sending the data frames. After that, the data frames are sent or transmitted by the sender using the newly established connection or path. In this service, each of the data frames that are sent or transmitted is assigned an individual number. Using this individual number, it confirms and guarantees that each of the data frames is received successfully at the receiver side without any duplication and with proper order and sequence.

Space for learners

CHECK YOUR PROGRESS - I

State TRUE or FALSE:

1. Data Link layer provides service to its upper layer.
2. The data link layer transmits data in terms of packet.
3. Unacknowledged connectionless service simply provides datagram style delivery.
4. Duplication of data delivery is done with the help of sequence number.
5. In acknowledged connectionless service, each data frame which is transmitted by the data link layer is not acknowledged individually.

1.4 FRAMING IN DATA LINK LAYER

To provide service to its upper layer, i.e., network layer, the data link layer must take the services provided by its lower layer, i.e., the physical layer. Physical layer at sender side accepts a raw bit stream and attempts to deliver it to the destination. The job of the data link layer is to break the bit stream into some frames and compute the checksum for each frame. Frames are the basic units of digital transmission mainly in computer networks and telecommunications. Framing provides a means for a source machine to transfer a set of bit streams that are meaningful to the intended receiver. Frame with different technology like Ethernet, token ring etc have their own structures. Each frame has frame headers which includes some information like error-checking codes etc. From the sender frame header information, it extracts

the message and using receiver address, it provides the frame to the receiver. The advantage of using frames is that message or data is broken up into some recoverable chunks which can be checked and verified easily for any error.

There are some problems in Framing –

- Detecting start of the frame: When a frame is sent, each station must be able to find the start of the frame. Stations detect frames by verifying the special sequence of bits that marks the starting of the frame which is known as SFD (Starting Frame Delimiter).
- How does a station detect a frame: Each station listen to the link for SFD pattern through a sequential circuit. If it detects SFD, sequential circuit does the necessary job for making alert the station. Station verifies destination address so that it can accept or reject frame.
- Detecting end of frame: Another issue of framing is to know when to stop reading the frame.

1.4.1 Framing Methods

In data link layer, after receiving the bit stream from physical layer, it is transmitted in terms of frame. Using framing technique, we can break the bit stream into frame but practically breaking bit stream into frame is not easy. One approach for framing technique is to introduce time gap between frames, such as the space that we put in between words in normal text. However, gap method does not provide any guarantee. Here, we will discuss some popular framing methods.

1.4.1.1 Character Count

Character count method is rarely used and it is basically required to count the total number of characters that are present in the frame. Figure 1 presents character count approach without errors and with an error in (a) and (b) respectively. Frame header field is used to keep the track of that count. In data link layer, character count method ensures the total number of characters present in the frame and the end of each frame at receiver or destination host.

Space for learners

There are some disadvantages in this character count method. If anyhow character count is distorted or unclear by an error happening during transmission, then receiver host may face synchronization problem. The destination or receiver host also may not be able to locate or identify the starting of next frame.

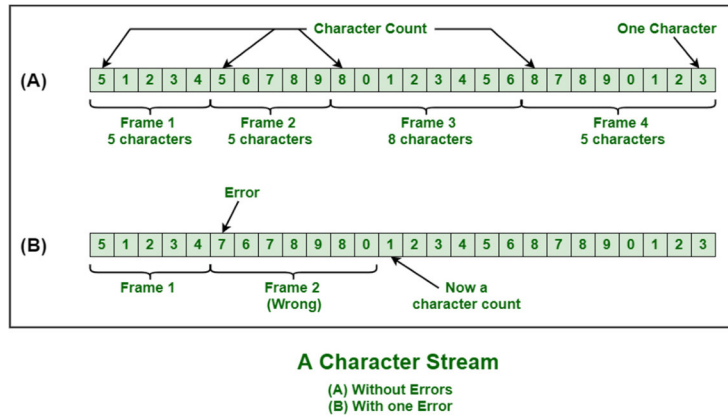
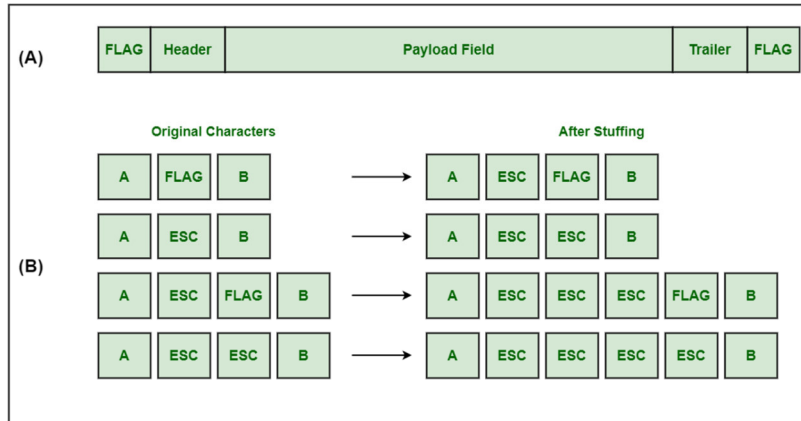

Figure 1. Character count method

1.4.1.2 Flag Bytes with Byte Stuffing

Character stuffing method is also known as byte stuffing or character-oriented framing. This method is same as bit stuffing method, only byte stuffing works on bytes whereas bit stuffing works on bit. In this byte stuffing method as presented in figure 2, special byte which is simply known as ESC (Escape Character) is normally added to the data stream or frame. This ESC is the same pattern with the flag byte. Same Flag bytes are used at the starting and ending of the frame. If the receiver sometimes loses synchronization due to some problem, it tries to find the flag byte to locate the end of the frame. Two consecutive flag bytes specify the end of one frame and the beginning of the next frame.



A Character Stuffing
 (A) A frame delimited by flag bytes
 (B) Four examples of byte sequences before and after byte stuffing

Figure 2. Character stuffing

1.4.1.3 Bit Stuffing

Bit stuffing is also known as bit-oriented framing. In this bit stuffing method, additional bits are added to the data streams. A special bit pattern indicates the starting and end of the frame.

Whenever the sender's data link layer encounters five consecutive 1s in the data, it automatically stuffs a 0 bit into the outgoing bit stream and at the receiver side receiver de-stuffs the 0 bit when it gets a 0 bit after five consecutive 1s. Whole procedure is explained below.

- (a) **0110111111111110** [Original data]
- (b) **01101111011111010** [After bit stuffing]
- (c) **0110111111111110** [After de-stuffing at receiver side]

1.4.1.4 Physical Layer Coding Violations

This method is generally applicable to the networks where the encoding on the physical medium contains some sort of redundancy.

For example,

- Some LANs encode 1 bit of data by taking 2 physical bits.
- Generally, a 1 bit is a high-low pair and a 0 bit is a low-high pair.

- 11 or 00 are not used for data but are used for delimiting frames in some protocols.

STOP TO CONSIDER

The main function of data link layer is framing, i.e. to break the bit stream received from physical layer into some frames and compute the checksum for each frame. In data link layer, frames are the basic units of digital transmission.

CHECK YOUR PROGRESS - II

Fill up the blanks:

6. One approach for _____ technique is to introduce time gap between the frames.
7. In data link layer, _____ method ensures the total number of characters present in the frame.
8. In bit stuffing method, additional _____ are added to the data streams
9. The job of the data link layer is to compute _____ the for each frame.
10. This ESC is the same pattern with the _____ byte.

1.5 ERROR CONTROL

In data link layer, error control is the process of detecting and correcting data frames which have been corrupted or lost during transmission. In case of lost or corrupted frames, the receiver does not receive the correct data-frame and sender does not know about the loss. Data link layer follows a method to detect transit errors and takes the required actions. It retransmits the frames whenever error is detected or frame is lost.

The error control mechanism in data link layer involves the following phases –

Space for learners

- Detection of Error – In data link layer, sender or the receiver detects the error, if any transmission error occurs.
- Acknowledgment –Receiver sends acknowledgment to sender; the acknowledgement may be positive or negative.
- Positive ACK – After receiving a correct frame, the receiver sends a positive acknowledgement.
- Negative ACK – After receiving a corrupted frame or a redundant frame, the receiver sends back a negative acknowledgment to the sender.
- Retransmission – The sender uses a timer and sets a timeout period. If an acknowledgment of anearlier transmitted data-frame does not arrive before the timeout period, or sender receives a negative acknowledgment, the sender retransmits the frame.

Space for learners

1.6 FLOW CONTROL

Flow control is a method which allows two stations to work at different speeds to communicate with each other. If the sender is sending at high speed and the receiver can't accept at that speed, data may be lost. So, some flow control method is required to regulate the data frame that is sent by a sender so that a fast sender does not overwhelm a slow receiver.

In data link layer, in one approach, the sender continues to send frames only after it has received acknowledgments from the user for the previous frames. This is called feedback-based flowcontrol. Here, a restriction is imposed on the number of frames the sender can send before it waits for an acknowledgment from the receiver.

Stop and Wait

In this stop and wait protocol, the sender sends a frame and waits for an acknowledgment for that particular frame. Once the receiver receives the frame, it sends back an acknowledgment frame to the sender. After receiving the acknowledgment frame, the sender understands that the receiver is ready to accept the next frame. So, it sends the next frame to the queue.

Sliding Window

This protocol improves the efficiency of stop and waits protocol by allowing multiple frames to be transmitted before receiving an acknowledgment. The methodology of this protocol is explained as follows –

Both sender and the receiver have fixed sized buffers called windows. Based on the size of the buffer, the sender and the receiver agree upon the number of frames to be transmitted. The sender transmits multiple frames sequentially, without waiting for acknowledgment. When the window is filled, then it waits for the acknowledgment. After receiving the acknowledgment, it advances the window and sends the next frames, as per the number of acknowledgments received.

STOP TO CONSIDER

In data link layer, error control is the process of detecting and correcting data frames that been corrupted or lost during transmission. Flow control method allows two stations working at different speeds to communicate with each other so that no frame is lost during transmission.

1.7 ERROR DETECTION AND CORRECTION

Error detection and correction is one of the major functions of data link layer. While sending a frame from sender to the receiver, there may be errors in the frame due to various reasons at the receiver side. In the following section, some error detection and correction techniques are discussed.

1.7.1 Error Detection Codes

Error-correcting codes are often used on wireless connection, which are very much noisy and erroneous compared to a wired connection. In case of fiber or copper wire, the error rate is comparatively lower, therefore error detection and retransmission is more efficient in case wired connection. We have three main methods for detecting errors in frames. Those are Parity Check, Checksum and Cyclic Redundancy Check (CRC).

Space for learners

1.7.1.1 Parity Check

In data link layer, the parity checking is done by adding an extra bit, called parity bit to the data to make a number of 1s either even to make it even parity or odd to make it odd parity. While making a frame, the sender counts the number of 1s in it and adds the parity bit in the following way.

To make it even parity, if the number of 1s is even then the value of parity bit is 0 and if the number of 1s is odd then the value of parity bit is 1. Similarly, in case of odd parity, if the number of 1s is odd then the value of parity bit 0 and if the number of 1s is even then the value of parity bit 1. After receiving a frame, the receiver counts the number of 1s in the frame. When even parity is used, if the number of 1s is even, the frame is accepted, otherwise it is rejected. Similarly, if odd parity is used, if the number of 1s is odd, it is accepted otherwise it is simply rejected. This parity bit checking method works better for single bit error detection only.

1.7.1.2 Checksum

In this checksum error detection method, data is divided into fixed sized frames. The sender adds the frame segments using 1's complement arithmetic to get the sum. Then it complements the sum to get the checksum and transmits it along with the data frames. At the receiver side, the receiver adds the incoming frame segments along with the checksum using 1's complement arithmetic. If the result is zero, the received frames are accepted; otherwise, frames are discarded.

1.7.1.3 Cyclic Redundancy Check (CRC)

Cyclic Redundancy Check (CRC) which is also known as polynomial code involves binary division of the data bits being sent by a predetermined divisor agreed upon by the communicating system. CRC or Cyclic Redundancy Check is a method of detecting accidental changes/errors in the communication channel. CRC uses Generator Polynomial which is available on both sender and receiver side. An example of generator polynomial is $x^3 + x + 1$. This generator polynomial

represents the key 1011. Another example is $x^2 + 1$ which represents the key 101.

Before sending the frame, following points are performed at the sender side.

- a. The binary data is first augmented by adding $k-1$ zeros at the end of the data.
- b. Use modulo-2 binary division to divide binary data by the key and store remainder of division.
- c. Append the remainder at the end of the data to form the encoded data and send the same.

Once the frame has been received, modulo-2 division again performed at the receiver side. If the remainder is 1 then there must be errors and if the remainder is 0, then there are no errors. If there is error, that must be handled properly.

Modulo 2 Division:

The process of modulo-2 binary division is the same as the familiar division process that we use for decimal numbers. In this modulo-2 division, instead of subtraction, we use XOR here. The steps are mentioned below.

- In each step, a copy of the divisor (or data) is XORed with the k bits of the dividend (or key).
- The result of the XOR operation (remainder) is $(n-1)$ bits, which is used for the next step after 1 extra bit is pulled down to make it n bits long.
- When there are no bits left to pull down, we have a result. The $(n-1)$ -bit remainder which is appended at the sender side.

The polynomial method is explained below by taking an example. The data word to be sent by the sender is 100100.

And the key taken is 1101 [or generator polynomial $x^3 + x^2 + 1$]

Space for learners

At the sender's side-

$$\begin{array}{r}
 111101 \\
 1101 \overline{) 100100000} \\
 \underline{1101} \\
 1000 \\
 \underline{1101} \\
 1010 \\
 \underline{1101} \\
 1110 \\
 \underline{1101} \\
 0110 \\
 \underline{0000} \\
 1100 \\
 \underline{1101} \\
 001
 \end{array}$$

From the above calculation, we have seen that the remainder is 001. Therefore, the encoded data sent is 100100001.

At the receiver side, the code word received by the receiver is 100100001. Again, the calculation is done as follows.

$$\begin{array}{r}
 111101 \\
 1101 \overline{) 100100001} \\
 \underline{1101} \\
 1000 \\
 \underline{1101} \\
 1010 \\
 \underline{1101} \\
 1110 \\
 \underline{1101} \\
 0110 \\
 \underline{0000} \\
 1101 \\
 \underline{1101} \\
 0000
 \end{array}$$

Here, at the receiver side we have seen that the remainder is all zeros. Hence, the data received has no any error.

Space for learners

1.7.2 Error Correction Techniques

Error correction techniques are used to find out the exact number of bits that have been corrupted and as well as their locations. There are two principal ways for error correction.

- Backward Error Correction (Retransmission) – If the receiver detects an error in the incoming frame, it requests the sender to retransmit the frame. This technique can be efficiently used only where retransmitting is not expensive and the time for retransmission is low compared to the requirements of the application.
- Forward Error Correction – If the receiver detects some error in the incoming frame, it performs error-correcting code that generates the actual frame. Using this method saves the bandwidth requirement for retransmission. However, if there are too many errors, the frames need to be retransmitted.

The codes which are used for both error detecting and error correction are called as “Error Correction Codes”. The error correction techniques are of two types. They are as follows.

- a. Single bit error correction: Here only single bit error is corrected.
- b. Burst error correction: In this method, burst errors in the data sequence are detected and corrected.

1.7.2.1 Hamming Distance

Normally a frame consists of m data (i.e., message) bits and r redundant or check bits. Let the total length be n (i.e., $n=m+r$). An n -bit containing m data bit and r -redundant bit is called n -bit codeword. Let us take two codewords, 10001001 and 10110001. Here, 3 bits differ between the two codewords. To determine, how many bits differ, just perform exclusive OR between the codewords and count the number of 1 bits in the result.

Space for learners

Here we have taken an example as follows-

10001001
10110001
00111000

The number of bit positions in which two codewords differ is called Hamming distance. The number of parity bits to be added to a data string depends upon the number of information bits of the data string which is to be transmitted. Number of parity bits will be calculated by using the data bits. This relation is given below.

$$2^P \geq n + P + 1$$

Here, n represents the number of bits in the data string and P represents number of parity bits.

For example, if we have 4-bit data string, i.e., $n = 4$, then the number of parity bits to be added can be found by using trial and error method.

Let's take $P = 2$, then

$$2^P = 2^2 = 4 \text{ and } n + P + 1 = 4 + 2 + 1 = 7.$$

This violates the actual expression.

So, let's try $P = 3$, then

$$2^P = 2^3 = 8 \text{ and } n + P + 1 = 4 + 3 + 1 = 8$$

So, we can say that 3 parity bits are required to transfer the 4-bit data with single bit error correction.

After calculating the number of parity bits required, we should know the appropriate positions to place them in the information string, to provide single bit error correction. In the above considered example, we have 4 data bits and 3 parity bits. So, the total codeword to be transmitted is of 7 (4 + 3) bits. We generally represent the data sequence from right to left, as shown below.

bit 7, bit 6, bit 5, bit 4, bit 3, bit 2, bit 1, bit 0

The parity bits have to be located at the positions of powers of 2. i.e., at 1, 2, 4, 8 and 16 etc. Therefore, the codeword after including the parity bits will be like this

Space for learners

D7, D6, D5, P4, D3, P2, P1

Here, P1, P2 and P3 are parity bits and D1-----D7 are data bits.
Now, we have to see how to operate with this code word.

P1 depends on upon the value of D3, D5 and D7. P2 depends on upon the value of D3, D6 and D7 and similarly P4 depends on upon the value of D5, D6 and D7.

Now we are taking an example. We want to transmit a 4-bit data having value 1011. Now depending upon these data, we have to remind the value of P1, P2 and P4. Here the D7, D6, D5 and D3 will have values 1011 respectively.

D7	D6	D5	P4	D3	P2	P1
1	0	1		1		

We know that P1 depends upon D3, D5 and D7.

$$P1 = D3, D5, D7$$

$$P1 = 1\ 1\ 1$$

To make it even parity, the value of P1 will be 1.

D7	D6	D5	P4	D3	P2	P1
1	0	1		1		1

P2 depends upon D3, D6 and D7.

$$P2 = D3, D6, D7$$

$P2 = 101$, to make it even parity the value of P2 will be 0.

D7	D6	D5	P4	D3	P2	P1
1	0	1		1	0	1

P4 depends on upon the value of D5, D6 and D7.

$$P4 = D5, D6, D7$$

$P4 = 101$, here also number of 1 is even, so the value P4 will be 0 to make it even parity.

D7	D6	D5	P4	D3	P2	P1
1	0	1	0	1	0	1

Space for learners

Therefore, we have to transmit the codeword 1010101 with even parity. Now the receiver will analyse the codeword for error detection and correction. Receiver will check for the parity bit. If it is even parity, then there is no error and if the codeword is having no even parity, then there must be error. In this way error is detected using parity bit.

Now we are taking an example to show how error is corrected below.

Example- If the 7-bit hamming code word received by a receiver is 1011011 with even parity. State whether the code word received is correct or wrong.

Solution-

The 7-bit hamming code is

D7	D6	D5	P4	D3	P2	P1
1	0	1	1	0	1	1

P4 is associated D5, D6 and D7, i.e. it depends upon D5, D6 and D7.

P4	D5	D6	D7	
1	1	0	1	-which is odd parity

But the code word was transmitted with even parity, hence there must be error. Here we have seen number of 1 is 3, i.e is odd. So P4=1.

P2 is associated D3, D6 and D7, i.e. it depends upon D3, D6 and D7.

P2	D3	D6	D7	
1	0	0	1	-which is even parity

Hence, there is no error. Here we have seen number of 1 is 2, i.e is even. So P2=0.

P1 is associated D3, D5 and D7, i.e. it depends upon D3, D5 and D7.

P1	D3	D5	D7	
1	0	1	1	-which is odd parity

Hence, there is error. Here we have seen number of 1 is 3, i.e is odd. So P1=1.

We have to find out P4, P2 and P1 depending upon whether they are depicting the true value or not.

$$P4 P3 P1 = 1 1 1 = (1 1 1)_2 = (5)_{10}$$

If we convert it to decimal, we get 5. Hence the 5th bit having the error, i.e. D5 is having the error and D5 should be 0 instead of 1. Hence the error has been located in the code word and error has been corrected at the receiver side.

STOP TO CONSIDER

We have three methods for detecting errors in frames. These are Parity Check, Checksum and Cyclic Redundancy Check (CRC). We may have single bit error and burst error in framing. Using Hamming Distance, this error can be corrected.

CHECK YOUR PROGRESS - III

Fill up the blanks:

11. Parity checking is done by adding extra bit, called _____ bit.
12. Cyclic redundancy check (CRC) is also known as _____.
13. Normally a frame consists of m data bit and r _____ bits.
14. The number of bit positions in which two codewords differ is called _____.
15. In _____, the number of 1s is even.

Space for learners

1.8 SUMMING UP

- One of the major functions of Data Link Layer is to provide service to Network Layer.
- Unacknowledged connectionless service basically provides datagram modes delivery without any error, issue, or flow control.
- In acknowledged connectionless service, no logical connection is established between the source and destination host and each frame that is transmitted is acknowledged individually.
- In acknowledged connection-oriented service, first connection is established between the source and the destination. After that the data frames are transmitted by the sender using the newly established connection.
- The job of the data link layer is to break the bit stream into some frames and compute the checksum for each frame.
- In data link layer, character count method ensures the total number of characters present in the frame and the end of each frame at receiver side.
- In this bit stuffing method, additional bits are added to the data streams. A special bit pattern indicates the starting and end of the frame.
- In data link layer, error control is the process of detecting and correcting data frames that have been corrupted or lost during transmission.
- Flow control is a method which allows two stations working at different speeds to communicate with each other.
- In data link layer, the parity checking is done by adding an extra bit, called parity bit to the data to make a number of 1s either even to make it even parity or odd to make it odd parity.
- CRC or Cyclic Redundancy Check is a method of detecting accidental errors in the communication channel.

Space for learners

- In single bit error correction, only single bit error is corrected and in case of burst error correction, burst errors in the data sequence are detected and corrected.
- Normally a frame consists of m data (i.e. message) bits and r redundant bits.
- The number of bit positions in which two codewords differ is called Hamming distance.

Space for learners

1.9 ANSWERS TO CHECK YOUR PROGRESS

- | | | | |
|---------------------|------------|-------------------|-----------|
| 1.True | 2.False | 3.True | 4.True |
| 5.False | 6.Framing | 7.Character Count | |
| 8.Bits | 9.Checksum | 10.Flag | 11.Parity |
| 12.Polynomial Code | | 13.Redundant | |
| 14.Hamming Distance | | 15.Even | |

1.10 POSSIBLE QUESTIONS

Short answer type questions:

1. What is the lower layer of data link layer in OSI Reference Layer?
2. Give an example of unacknowledged connectionless service.
3. What is starting frame delimiter (SFD)?
4. What is bit oriented framing?
5. What is feedback based flow control?
6. What is burst error?
7. What is bit stuffing?
8. Why negative acknowledgement is used in error control?

Long answer type questions:

1. What are the different services provided by data link layer?
2. What are the major problems of framing?
3. Explain different Framing methods.

4. What are the different phases of error control mechanism in data link layer?
5. Explain the two principal ways for error correction?
6. Explain cyclic redundancy check (CRC) method with an example.
7. Explain how hamming distance method can be used for single bit error correction?

1.11 REFERENCES AND SUGGESTED READINGS

1. Computer Networks, Andrew S. Tanenbaum, David J. Wetherall.
2. Data Communications and Networking, Behrouz A. Forouzan.

Space for learners

UNIT 2: THE DATA LINK LAYER: THE PROTOCOLS

Space for learners

Unit Structure:

- 2.1 Introduction
- 2.2 Unit Objectives
- 2.3 Basic terms and their Definitions
- 2.4 The Protocols
- 2.5 Noiseless Channel Protocols
 - 2.5.1 Unrestricted Simplex Protocols
 - 2.5.2 Simplex Stop-and-Wait Protocol
- 2.6 Noisy Channel Protocols
 - 2.6.1 Simplex Protocol for noisy channel
 - 2.6.2 Sliding Window Protocol
- 2.7 HDLC (High-Level Data Link Control)
- 2.8 Summing Up
- 2.9 Answers to Check Your Progress
- 2.10 Possible Questions
- 2.11 References and Suggested Readings

2.1 INTRODUCTION

In this unit, you will learn about the second layer of the OSI model in computer networking, which is the Data Link Layer (DLL). It is also known as the protocol layer as it assumes responsibility of data transmission between adjacent network nodes in a wide area network (WAN) or between nodes on the same local area network (LAN) segment. This layer is involved in multiple activities including framing, addressing, synchronization, error control, flow control, and multi access. The different protocols and how they function to accomplish all the tasks will be discussed in detail in this unit.

2.2 UNIT OBJECTIVES

After going through this unit, you will be able to:

- Understand the functions of the data link layer.
- Know about data link layer protocols.
- Understand the concept of simplex, half duplex, and full duplex communication.
- Learn about noisy and noiseless channels.
- Learn about flow control protocols.

2.3 BASIC TERMS AND THEIR DEFINITIONS

When discussing about protocols in computer networks some terms find very frequent usage. For a better grip on the concepts, let us learn about some of those basic terms here, to facilitate our learning.

- Data link frame:** A frame is a unit of communication in the data link layer. Data link layer takes the packets from the Network Layer and encapsulates them into frames. If the frame size becomes too large, then the packet may be divided into small sized frames. At receiver's end, data link layer picks up signals from hardware and assembles them into frames.
- Simplex:** The transmission mode defines the direction of signal flow between two connected devices. There exist three modes of communication, namely simplex, half-duplex, and full-duplex. In simplex mode of transmission, the communication is unidirectional, or one-way, for e.g., keyboard, monitor etc.
- Half-duplex:** The second type of transmission mode is the half-duplex, in such a transmission the communication is two-directional, but the channel is interchangeably used by both of the connected devices, for e.g., walkie talkie.
- Full-duplex:** The third type of transmission mode is the full-duplex, in this transmission mode the communication is bi-directional or two-way, and the channel is used by both of the connected devices simultaneously, for e.g., telephone.

Space for learners

- v. **Noiseless channel:** An idealistic channel in which no frames are lost, corrupted or duplicated is called a noiseless channel. The protocols do not implement error control in this category as it being an idealistic channel, it is considered to be error-free.
- vi. **Noisy channel:** Unlike a noiseless channel, it is not an idealistic channel. A noisy channel signifies disturbances or occurrence of unwanted interference during data transmission from sender to receiver. It is also a practical and realistic approach towards data transmission, as noiseless channel is a hypothetical concept.

Space for learners

CHECK YOUR PROGRESS - I

1. The _____ of signal flow between two _____ devices are defined by transmission mode.
2. A simplex mode of transmission is _____.
3. _____ is an example of a half-duplex device.
4. In _____ transmission mode both sender and receiver can communicate at the same time.
5. A noiseless channel is _____ in nature.
6. Error control is required in a _____ channel.
7. State true or false
 - a. The term used for data units at the data link layer is frames.
 - b. Two computers connected via an Ethernet cable is an example of half-duplex.
 - c. SMS is an example of full-duplex.

2.4 THE PROTOCOLS

Data-link frames do not cross the boundaries of a local network. Inter-network routing and global addressing are higher-layer functions, allowing data-link protocols to focus on local delivery,

addressing, and media arbitration. The DLL also takes care of flow control of the data. When devices attempt to use a medium simultaneously, frame collisions occur. In this situation, data-link protocols also specify how devices can be detected and recovered from such collisions, and may provide mechanisms to reduce or prevent them. As the DLL assumes various roles and responsibilities, these are carried out with the help of some protocols specifically designed for the purpose. One of the major functions of the data link layer is to control the flow of data to and from the adjacent layers. A receiving node can receive the frames at a faster rate than it can process the frame. Without flow control, the receiver's buffer can overflow, and frames can get lost. To overcome this problem, the data link layer uses the flow control to prevent the sending node on one side of the link from overwhelming the receiving node on another side of the link.

Many protocols are defined for the data transmission in the DLL. The protocols have been categorized as shown in Figure 2.1.

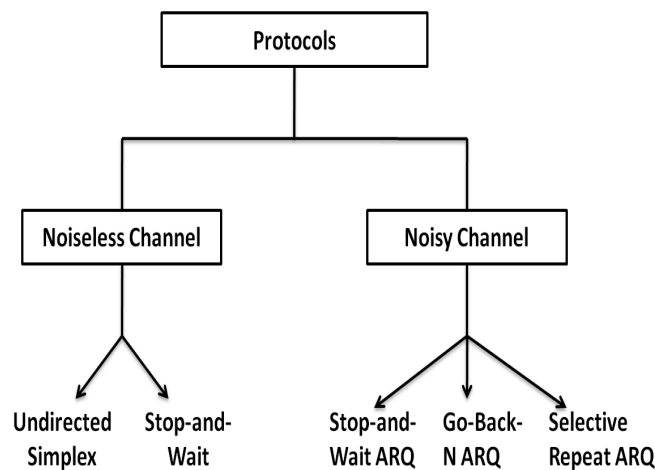

Fig 2.1: Categorization of flow control protocols

2.5 NOISELESS CHANNEL PROTOCOLS

In this type of noiseless channel protocol, no frames are lost, corrupted or duplicated. So, no error control mechanism is implemented here. Some of the noiseless channel protocols are explained below.

2.5.1 Unrestricted Simplex Protocols

The simplex protocol is a data link layer protocol for transmission of frames over the computer network. It is a hypothetical protocol designed for unidirectional data transmission over an ideal channel, i.e., a channel through which transmission can never go wrong.

It is assumed that both the sender and the receiver are always ready for data processing and both of them have infinite buffer. The sender simply sends all the available data onto the channel as soon as buffer is available. The receiver is assumed to process all incoming data instantly. It does not handle flow control or error control. Since this protocol is totally unrealistic, it is often called Utopian Simplex protocol. Figure 2.2 presents the concept of Unidirectional Simplex protocol.

The significance of this protocol lies in the fact that it shows the basic structure on which the usable protocols are built.

Design:

- **Sender Side:** The data link layer in the sender side waits for the network layer to send a data packet. On receiving the packet, it immediately processes it and sends it to the physical layer for transmission.
- **Receiver Side:** The data link layer in the receiver side waits for a frame to be available. When it is available, it immediately processes it and sends it to the network layer.

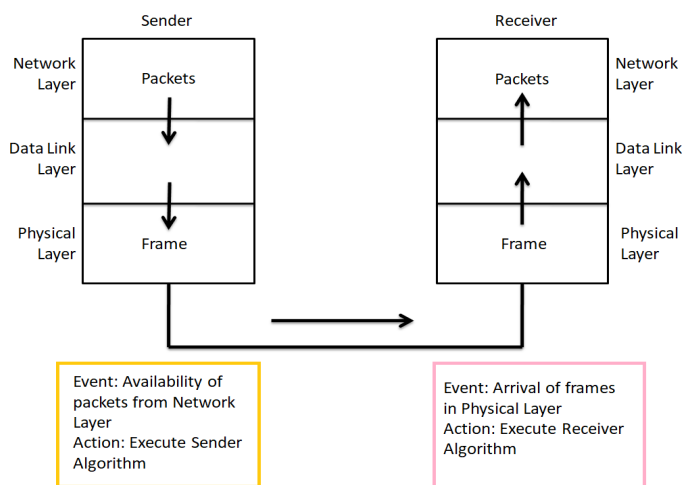

Figure 2.2: Unidirectional Simplex Protocol

Space for learners

The algorithm of this protocol is stated in the following.

```
Algorithm
Sender Side:
1  while (true)                # repeat forever
2  {
3  EventWait();                # sleep until an
                               event occurs
4  if (Event (SendRequest))    # there is a packet
                               to send
5  {
6      GetData();
7      MakeFrame();
8      SendFrame();            # send the frame
9  }
10 }
```

```
Algorithm
Receiver Side:
1  while (true)                # repeat forever
2  {
3  EventWait();                # sleep until an
                               event occurs
4  if (Event (ArrivalNotification)) # frame arrived
5  {
6      ReceiveFrame();
7      ExtractData();
8      DeliverData();          # deliver data to
                               network layer
9  }
10 }
```

Space for learners

Figure2.3 depicts communication via unrestricted simplex protocol for noiseless channel.

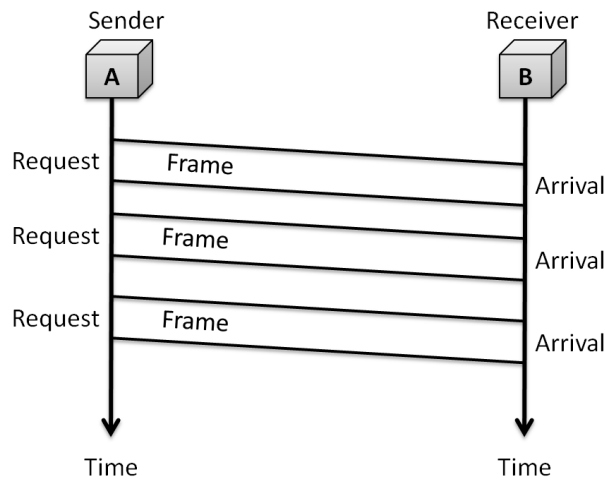

Figure2.3: Flow of Unrestricted Simplex Protocol

Space for learners

2.5.2 Simplex Stop-And-Wait Protocol

Stop and Wait protocol is a data link layer protocol for transmission of frames over noiseless channels. It provides unidirectional data transmission with flow control facilities but without error control facilities.

This protocol takes into account the fact that the receiver has a finite processing speed. If data frames arrive at the receiver's end at a rate which is greater than its rate of processing, frames are dropped out. In order to avoid this, the receiver sends an acknowledgement for each frame upon its arrival. The sender sends the next frame only when it has received a positive acknowledgement from the receiver that it is available for further data processing. Figure2.4 depicts Simplex Stop-and-Wait protocol.

Design

- **Sender Side:** The data link layer in the sender side waits for the network layer for a data packet. It then checks whether it can send the frame. If it receives a positive notification from the physical layer, it makes frames out of the data and sends it. It then waits for an acknowledgement before sending the next frame.

- **Receiver Side:** The data link layer in the receiver side waits for a frame to arrive. When it arrives, the receiver processes it and delivers it to the network layer. It then sends an acknowledgement back to the sender.

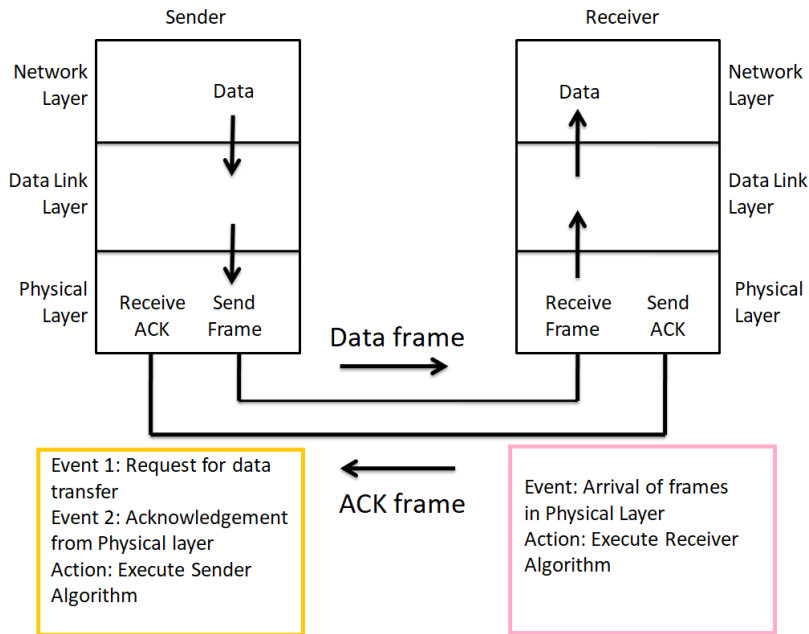

Figure2.4: Simplex Stop-and-Wait protocol

Algorithm of Simplex Stop-and-Wait protocol is explained in the following.

```

Algorithm
Sender Side:
1  while (true)                                # repeat forever
2  canSend = true;                             # allow first frame to go
3  {
4  EventWait();                                # sleep until an event occurs
5  if (Event (SendRequest) AND                 # there is a packet to send
    canSend)
6  {
7      GetData();
8      MakeFrame();
9      SendFrame();                             # send the frame

```

Space for learners

```

10  canSend = false;                # cannot send until
                                     ACK arrives
11  }
12  EventWait();                    # sleep until an event
                                     occurs
13  if (Event (ArrivalNotification)) # an ACK has arrived
14  {
15  ReceiveFrame();                 # receive the ACK
                                     frame
16  canSend = true;
17  }
18  }

```

Space for learners

Algorithm

Receiver Side:

```

1  while (true)                      # repeat forever
2  {
3  EventWait();                      # sleep until an
                                     event occurs
4  if (Event (ArrivalNotification)) # frame arrived
5  {
6  ReceiveFrame();
7      ExtractData();
8      DeliverData();                # deliver data to
                                     network layer
9  SendFrame();                      # send an ACK
                                     frame
10 }
11 }

```

The Figure2.5 presents communication via simplex stop-and-wait protocol for noiseless channel.

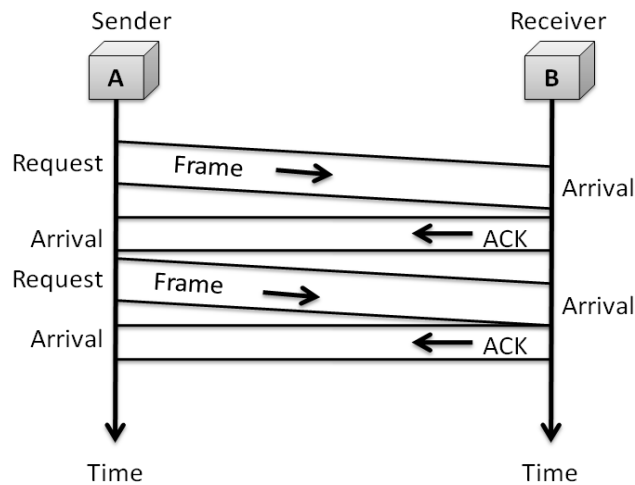

Figure2.5: Communication via Simplex Stop-and-Wait protocol

Space for learners

STOP TO CONSIDER

- Data link layer protocols can be categorized on the basis of type of channel, i.e. noiseless or noisy.
- Flow control is a way of controlling the amount of data being sent or received in order to avoid unnecessary collisions and reduce network traffic or congestion.

CHECK YOUR PROGRESS - II

Fill up the blanks:

8. The unrestricted simplex protocol can be implemented for a _____ channel.
9. State true or false:
 - a. In unrestricted protocol it is assumed that both stations have infinite buffer.
 - b. Simplex Stop-and-Wait allows data transmission with error control facilities but without flow control facilities.

2.6 NOISY CHANNEL PROTOCOLS

Unlike a noiseless channel, noisy channel is not an idealistic channel. A noisy channel may have disturbances or occurrence of unwanted interference during data transmission from sender to receiver. Some of the noisy channel protocols are explained below.

2.6.1 Simplex Protocol for Noisy Channel

Simplex Stop and Wait protocol for noisy channel is a data link layer protocol for data communications with error control and flow control mechanisms. It is popularly known as Stop-and-Wait Automatic Repeat Request (Stop-and-Wait ARQ) protocol. It adds error control facilities to Stop-and-Wait protocol. Figure 2.6 shows Stop-and-Wait Protocol for noisy channel.

This protocol takes into account the facts that the receiver has a finite processing speed and that the frames get corrupted while transmission. If data frames arrive at the receiver's end at a rate which is greater than its rate of processing, frames can be dropped out. Also, frames may get corrupted or entirely lost when they are transmitted via network channels. So, the receiver sends an acknowledgment for each valid frame that it receives. The sender sends the next frame only when it has received a positive acknowledgment from the receiver that it is available for further data processing. Otherwise, it waits for a certain amount of time and then resends the frame.

Design:

- **Sender Side:** At the sender side, a field is added to the frame to hold a sequence number. If data is available, the data link layer makes a frame with the certain sequence number and sends it. The sender then waits for arrival of acknowledgment for a certain amount of time. If it receives a positive acknowledgment for the frame with that sequence number within the stipulated time, it sends the frame with next sequence number. Otherwise, it resends the same frame.
- **Receiver Side:** The receiver also keeps a sequence number of the frames expected for arrival. When a frame arrives, the receiver processes it and checks whether it is valid or not. If it is valid and its sequence number matches the sequence

Space for learners

number of the expected frame, it extracts the data and delivers it to the network layer. It then sends an acknowledgement for that frame back to the sender along with its sequence number.

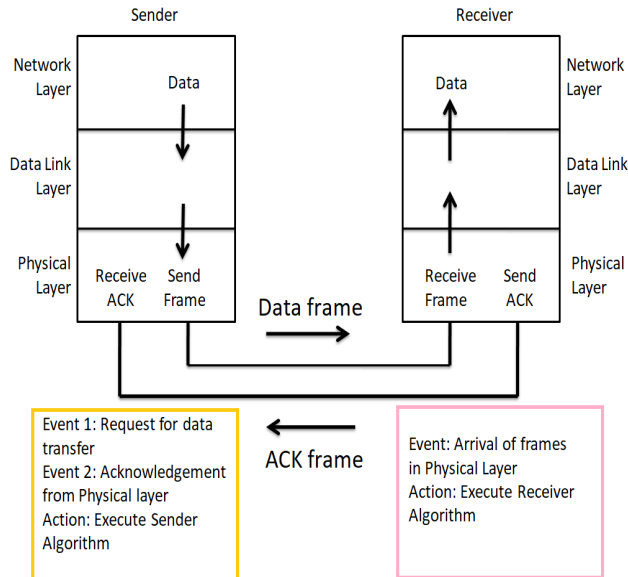

Figure2.6: Stop-and-Wait Protocol for noisy channel

The following flow diagram as depicted in figure 2.7 presents communication via simplex stop – and – wait ARQ protocol for noisy channel –

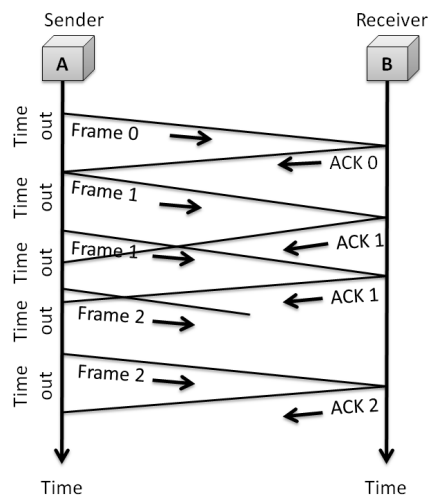

Figure2.7: Communication via Simplex Stop-and-Wait ARQ protocol for noisy channel

Space for learners

The Stop-and-Wait protocol is inefficient if the channel is thick and long. By thick, a channel with a large bandwidth is indicated and by long the round-trip delay is indicated to be long. The product of both is the bandwidth delay product. The bandwidth delay product is a measure of the number of bits that can be sent out of the system while waiting for news from the receiver.

Example 1:

Assume that in a Stop-and-Wait ARQ system, the bandwidth of the line is 1.5 Mbps, and 1 bit takes 10 ms to make a round trip. What is the bandwidth delay product? If the system data frames are 1000 bits in length, what is the utilization percentage of the link?

Solution: The bandwidth delay product is $(1.5 \times 10^6) \times (10 \times 10^{-3}) = 15,000$ bits

The system can send 15,000 bits during the time it takes for the data to go from sender to receiver and back to again. But, the system sends only 1000 bits. We can say that the link utilization is only $1000/15,000$, or 6.67%. For this reason, for a link with a high bandwidth or long delay, the use of Stop-and-Wait ARQ wastes the capacity of the link.

Example 2:

In the previous example, what is the utilization percentage of the link if we have a protocol that can send up to 10 frames before stopping and worrying about acknowledgements?

Solution: The bandwidth delay product continues to be 15,000 bits. The system can send up to 10 frames or 10,000 bits during a round trip. This means the utilization is $10,000/15,000$, or 66.67%. In case there are damaged frames, the utilization percentage is much less as frames have to be resent.

2.6.2 Sliding Window Protocol

The sliding window is a technique for sending multiple frames at a time. It controls the data packets between the two devices where reliable and gradual delivery of data frames is needed. It is also used in TCP (Transmission Control Protocol).

In this technique, each sending frame has the sequence number. The sequence numbers are used to find the missing data in the receiver end. The purpose of the sliding window technique is to avoid duplicate data, so it uses the sequence number. Sliding window protocol has two types:

1. Go-Back-N ARQ
2. Selective Repeat ARQ

2.6.2.1 Protocol using Go Back N

In Go-Back-N ARQ, **N** is the sender's window size. Suppose we say that Go-Back-3, which means that the three frames can be sent at a time before expecting the acknowledgment from the receiver. It uses the principle of protocol pipelining in which the multiple frames can be sent before receiving the acknowledgment of the first frame. If we have five frames and the concept is Go-Back-3, which means that the three frames can be sent, i.e., frame no 1, frame no 2, frame no 3 can be sent before expecting the acknowledgment of frame no 1.

In Go-Back-N ARQ, the frames are numbered sequentially as Go-Back-N ARQ sends the multiple frames at a time that requires the numbering approach to distinguish the frame from another frame, and these numbers are known as the sequential numbers. The number of frames that can be sent at a time totally depends on the size of the sender's window. So, we can say that 'N' is the number of frames that can be sent at a time before receiving the acknowledgment from the receiver. If the acknowledgment of a frame is not received within an agreed-upon time period, then all the frames available in the current window will be retransmitted. Suppose we have sent the frame no 5, but we didn't receive the acknowledgment of frame no 5, and the current window is holding three frames, then these three frames will be retransmitted.

The sequence number of the outbound frames depends upon the size of the sender's window. Suppose the sender's window size is 2, and we have ten frames to send, then the sequence numbers will not be 1,2,3,4,5,6,7,8,9,10. Let's understand through an example.

- N is the sender's window size.

- If the size of the sender's window is 4 then the sequence number will be 0,1,2,3,0,1,2,3,0,1,2, and so on.

The number of bits in the sequence number is 2 to generate the binary sequence 00,01,10,11.

Example 3:

A 2 Mbps satellite link connects two ground stations. The altitude of the satellite is 36504 km and speed of the signal is 3×10^8 m/sec. What should be the packet size for a channel utilization of 50% for a satellite link using go back 127 sliding window protocol?

Solution: Given-

- Bandwidth = 2 Mbps
- Distance = 2×36504 km = 73008 km
- Propagation speed = 3×10^8 m/sec
- Efficiency = 50% = 1/2
- Go back N is used where N = 127

Let the packet size be L bits.

Transmission delay (T_t) = Packet size / Bandwidth

$$= L \text{ bits} / 2 \text{ Mbps}$$

$$= 0.5 L \text{ } \mu\text{sec}$$

Propagation delay (T_p) = Distance / Speed

$$= (73008 \times 10^3 \text{ m}) / (3 \times 10^8 \text{ m/sec})$$

$$= 24336 \times 10^{-5} \text{ sec}$$

$$= 243360 \text{ } \mu\text{sec}$$

$$a = T_p / T_t$$

$$a = 243360 \text{ } \mu\text{sec} / 0.5L \text{ } \mu\text{sec}$$

$$a = 486720 / L$$

Efficiency (η) = $N / (1+2a)$

Substituting the values, we get-

$$1/2 = 127 / (1 + 2 \times 243360 / L)$$

Space for learners

$$1/2 = 127 \times L / (L + 486720)$$

$$L + 486720 = 254 \times L$$

$$253 \times L = 486720$$

$$L = 1924$$

From here, packet size = 1924 bits or 240 bytes.

Example 4:

A 20 Kbps satellite link has a propagation delay of 400 ms. The transmitter employs the “go back n ARQ” scheme with n set to 10. Assuming, that each frame is 100 bytes long, what is the maximum data rate possible?

Solution: Given-

Bandwidth = 20 Kbps

Propagation delay (T_p) = 400 ms

Frame size = 100 bytes

Go back N is used where $N = 10$

Transmission delay (T_t) = Frame size / Bandwidth

$$= 100 \text{ bytes} / 20 \text{ Kbps}$$

$$= (100 \times 8 \text{ bits}) / (20 \times 10^3 \text{ bits per sec})$$

$$= 0.04 \text{ sec}$$

$$= 40 \text{ msec}$$

$$a = T_p / T_t$$

$$a = 400 \text{ msec} / 40 \text{ msec}$$

$$a = 10$$

Efficiency (η) = $N / (1+2a) = 10 / (1 + 2 \times 10)$

$$= 10 / 21$$

$$= 0.476$$

$$= 47.6 \%$$

Space for learners

Maximum data rate possible or Throughput

= Efficiency x Bandwidth

= 0.476 x 20 Kbps

= 9.52 Kbps

≅ 10 Kbps

Space for learners

2.6.2.1 Protocol Using Selective Repeat

Selective repeat protocol, also called Selective Repeat ARQ (Automatic Repeat Request), is a data link layer protocol that uses sliding window method for reliable delivery of data frames. Here, only the erroneous or lost frames are retransmitted, while the good frames are received and buffered.

It uses two windows of equal size: a sending window that stores the frames to be sent and a receiving window that stores the frames received by the receiver. The size is half the maximum sequence number of the frame. For example, if the sequence number is from 0 – 15, the window size will be 8.

Working Principle:

Selective Repeat protocol provides for sending multiple frames depending upon the availability of frames in the sending window, even if it does not receive acknowledgement for any frame in the interim. The maximum number of frames that can be sent depends upon the size of the sending window.

The receiver records the sequence number of the earliest incorrect or un-received frame. It then fills the receiving window with the subsequent frames that it has received. It sends the sequence number of the missing frame along with every acknowledgement frame. The sender continues to send frames that are in its sending window. Once, it has sent all the frames in the window, it retransmits the frame whose sequence number is given by the acknowledgements. It then continues sending the other frames.

STOP TO CONSIDER

- In Stop-and-Wait ARQ, an improvisation was made to the simplex Stop-and-Wait by adding an error control mechanism.
- In Go-Back-N ARQ a number of frames are sent sequentially before receiving acknowledgement to improve transmission efficiency.
- In Selective Repeat only lost or erroneous frames are resent.

CHECK YOUR PROGRESS - III

Fill up the blanks:

10. ARQ stands for _____.
11. The Stop-and-Wait protocol is inefficient if the channel is _____ and _____.
12. The purpose of the sliding window technique is to avoid _____ data, so it uses the _____ number.
13. State true or false
 - a. In Stop-and-Wait ARQ the sender sends an acknowledgement _____ on receiving acknowledgement from receiver.
 - b. The concept of acknowledgement and timeout is introduced in Stop-and-Wait for noisy channels.
 - c. TCP stands for Transportation Control Protocol.
 - d. 'N' in Go-Back-N ARQ is the number of frames that can be sent at a time before receiving the acknowledgment from the receiver.

2.7 HDLC (HIGH-LEVEL DATA LINK CONTROL)

HDLC (High-level Data Link Control) is a group of protocols or rules for transmitting data between network points (sometimes called nodes).

In more technical terms, HDLC is a bit-oriented, synchronous data link layer protocol created by the International Organization for Standardization (ISO). The standard for HDLC is ISO/IEC 13239:2002. ECI stands for the International Electrotechnical Commission, an international electrical and electronic standards body that often works with the ISO.

Working Principle:

HDLC provides two common transmission modes namely normal response mode (NRM) and asynchronous balanced mode (ABM).

In normal response mode the station configuration is imbalanced. There exists one primary station and multiple secondary stations. While a primary station is used for sending instructions or commands, the secondary stations are only capable of responding. The NRM is applied at both point-to-point as well as multi-point links.

In asynchronous balanced mode as the name suggests, the station configuration is balanced. The link is point-to-point, and each station acts as both primary and secondary stations (act as peers).

To provide flexibility, HDLC basically uses and explains three different types of frames:

1. I-Frames (Information)
2. S-Frames (Supervisory)
3. U-Frames (Unnumbered)

Type of frame is basically determined by control field of frame. Each type of frame generally serves as an envelope for transmission of various types of messages.

I-frame stands for Information frames. This frame is generally used for transporting user data from network layer. These frames actually carry actual data or information of upper layer and some control information. This frame carries data along with both send sequence number and an acknowledgment number. It can also be used to piggyback acknowledgment information in case of ABM (Asynchronous Balanced Mode). The first bit of this frame of control field is 0.

S-frame stands for Supervisory frames. These frames are basically required and essential for error control and flow control. They also provide control information. It contains or includes only an Acknowledgment number. First two bit of this frame of control field is 10. S-frame does not have any information fields. This frame contains send and receives sequence numbers.

Space for learners

U-frame stands for Unnumbered frames. These frames are also required in various functions like link setup and disconnections. These frames basically support control purposes and are not sequenced. First two bits of this frame of control field is 11. Some U-frames contain an information field depending upon type. These frames are also used for different miscellaneous purposes along with link management. U-frame is required for managing link itself. This frame does not include any type of acknowledgment information i.e. in turn it includes or contained in sequence number. These frames are generally reserved for system management.

Each frame in the HDLC frame format consists up to six fields as shown in Figure 2.8.

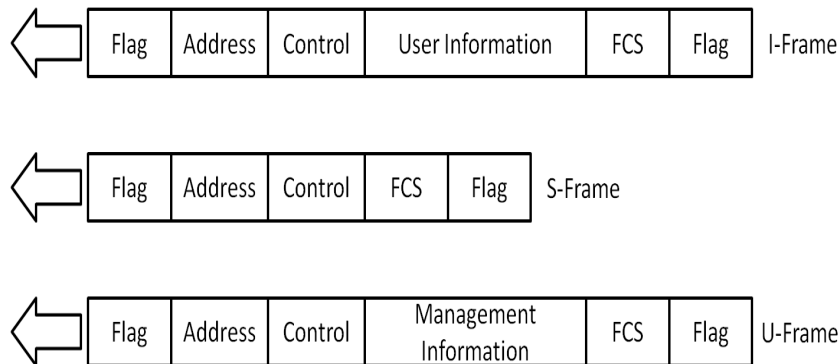

Figure 2.8: Frame format fields in HDLC

The functions of the different fields are as follows:

- **Flag field:** The flag field of an HDLC frame is an 8-bit sequence with the bit pattern 01111110 that identifies both the beginning and the end of a frame and serves as a synchronization pattern for the receiver.
- **Address field:** The second field of an HDLC frame contains the address of the secondary station. If a primary station created the frame, it contains a to address. If a secondary creates the frame, it contains a from address. An address field can be 1 byte or several bytes long depending upon the needs of the network.
- **Control field:** The control field is a 1 or 2 bytes segment of the frame used for flow and error control. The

interpretation of bits in this field depends on the frame type.

- Information field: The information field contains the user's data from the network layer or management information. Its length can vary from one network to another.
- FCS field: The frame check sequence (FCS) is the HDLC error detection field. It can contain either a 2- or 4-byte ITU-T CRC.

CHECK YOUR PROGRESS - IV

Fill up the blanks:

14. The maximum window size for data transmission using the selective repeat protocol with n bit frame sequence numbers is _____.

15. In selective repeat only the _____ or _____ frames are retransmitted.

16. HDLC is a _____ oriented protocol.

17. NRM is applied to both _____ as well as _____ links.

STOP TO CONSIDER

- HDLC protocol is a bit-oriented protocol which is used for data transmission that classifies frames into I-Frame, S-Frame, and U-Frame.

2.8 SUMMING UP

- The second layer of the OSI model i.e., the Data Link Layer is responsible for data transmission between the Physical and Network Layers.
- For accomplishing various tasks on the network, the DLL implements certain protocols specific to data transmission activities.

Space for learners

- Protocols can be categorized on the basis of type of channel: noiseless or noisy.
- Flow control is the task of controlling amount of data being sent or received in order to avoid unnecessary collisions and reduce network traffic or congestion.
- For noiseless channels we discussed Unrestricted Simplex protocol and Simplex Stop-and-Wait protocol which lack either flow control or error control activities or both.
- For noisy channels we discussed Stop-and-Wait ARQ, Go-Back-N ARQ and Selective Repeat protocols. In Stop-and-Wait ARQ, an improvisation was made to the simplex Stop-and-Wait by adding an error control mechanism. In Go-Back-N ARQ a number of frames are sent sequentially before receiving acknowledgement to improve transmission efficiency, and in Selective Repeat only lost or erroneous frames are resent.
- Both Go-Back-N ARQ and Selective Repeat use the concept of sliding window. If m is the number of bits for the sequence number, then the size of the send window must be less than 2^m , size of the receiver window must always be 1. In Selective repeat the size of sender and receiver window must be at most one half of 2^m .
- HDLC protocol is a bit oriented protocol used for data transmission which classifies frames into I-Frame, S-Frame, and U-Frame.

Space for learners

2.9 ANSWERS TO CHECK YOUR PROGRESS

1. Direction, Connected
2. Unidirectional
3. Walkie talkie
4. Full-duplex
5. Idealistic
6. Noisy
7. a. True, b. False, c. False
8. Noiseless
9. a. True, b. False
10. Automatic Repeat Request
11. Thick, Long

12. Duplicate, Sequence
13. a. False, b. True, c. False, d. True
14. 2^{n-1}
15. Erroneous, Lost
16. Bit
17. Point-to-point, Multi-point

Space for learners

2.10 POSSIBLE QUESTIONS

Short answer type questions:

1. What is protocol?
2. State three examples of half-duplex transmission mode.
3. Define framing and the reason for its need.
4. Differentiate between noiseless and noisy channels.
5. What are the two sliding window protocols?
6. What is the size of the window for Go-Back-N ARQ Protocol?
7. What is the size of the window for Selective Repeat ARQ Protocol?
8. Give the full forms of: NRM, ABM
9. Differentiate between NRM and ABM.
10. What is bandwidth propagation delay?
11. Differentiate between I-Frame and S-Frame.
12. Why is the U-Frame used in HDLC?
13. What is frame check sequence?

Long answer type questions:

1. Discuss the functions of the Data Link Layer.
2. Distinguish between Simplex, Half-Duplex and Full-Duplex.
3. Describe the Unrestricted Simplex Protocol for Noiseless channel.
4. Differentiate between the Stop-and-Wait protocols for noiseless and noisy channels.
5. Explain with reasons why Go-Back-N ARQ was introduced and how it improved Stop-and-Wait protocol.
6. What are the advantages of Selective Repeat ARQ over other transmission protocols?
7. Compare and contrast the two sliding window protocols.
8. How is the HDLC Protocol different from the other data transmission protocols?

9. Elaborate the types of data frames used by the HDLC Protocol.
10. What are the fields used in the HDLC frame formats?

2.11 REFERENCES AND SUGGESTED READINGS

1. Computer Networks, Andrew S. Tanenbaum, David J. Wetherall.
2. Data Communications and Networking, Behrouz A. Forouzan

Space for learners

UNIT 3: MAC SUB LAYER

Unit Structure:

- 3.1 Introduction to MAC Sub Layer
 - 3.1.1. Functions of MAC Sub Layer
- 3.2. The Channel Allocation Problem in Computer Network
 - 3.2.1. Static Channel Allocation in LANs and MANs
 - 3.2.2. Dynamic Channel Allocation
- 3.3. ALOHA
 - 3.3.1. Pure ALOHA
 - 3.3.2. Slotted ALOHA
- 3.4. Carrier Sense Multiple Access (CSMA)
 - 3.4.1.1-Persistent
 - 3.4.2. Non-Persistent
 - 3.4.3. P-Persistent
- 3.5. Carrier Sense Multiple Access with Collision Detection (CSMA/CD)
- 3.6. Carrier Sense Multiple Access with Collision Avoidance (CSMA/CA)
- 3.7. Collision Free Protocols
 - 3.7.1. A Bit Map Protocol
 - 3.7.2. Binary Countdown
 - 3.7.3. Limited Contention Protocols
 - 3.7.4. Adaptive Tree Walk Protocol
- 3.8. Wavelength Division Multiple Access Protocol
- 3.9. Summing Up
- 3.10. Answers to Check Your Progress
- 3.11. Possible Questions
- 3.12. References and Suggested Readings

3.1 INTRODUCTION TO MAC SUBLAYER

Network can be divided into two categories: 1) Point to point and 2) Broadcast Channels. MAC sub layer deals with broadcast networks and their protocols. It is also known as the Media Access Control-a sub layer of the data link layer. It shares a common communication medium and these are local area networks. This layer is the “low” part of the second OSI layer. The IEEE divided this layer into two layers “above” is the control layer the logical connection (Logical Link Control, LLC) and “down” the control layer, the medium access (MAC).

Figure 3.1 depicts the presence of the MAC layer in data link layer.

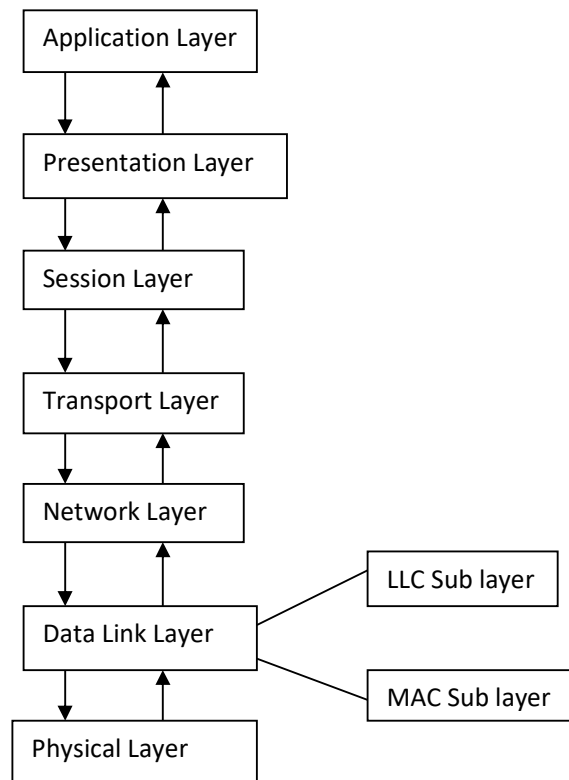

Figure 3.1 The presence of the MAC layer in data link layer

Space for learners

3.1.1 Functions of MAC Sublayer

- 1) It provides an abstraction of the physical layer to the LLC and upper layers of the OSI network.
- 2) It is responsible for encapsulating frames so that they are suitable for transmission via the physical medium.
- 3) It resolves the addressing of source station as well as the destination station or groups of destination stations.
- 4) It performs multiple access resolutions when more than one data frame is to be transmitted.
- 5) MAC deals with broadcast channels and is especially important in LANs, many of which use a multi-access channel as the basis of communication.

3.2 THE CHANNEL ALLOCATION PROBLEM IN COMPUTER NETWORK

Channel allocation is a process in which a single channel is divided and allotted to multiple users for user specific tasks. User's quantity may vary every time the process takes place.

If there are M number of users and channel is divided into M equal-sized sub channels, each user is assigned one portion. If the number of users is small and don't vary at times, then Frequency Division Multiplexing can be used.

Channel allocation problem can be solved by two schemes:

- 1) Static channel allocation in LANs and MANs and
- 2) Dynamic channel allocation.

3.2.1 Static Channel Allocation in LAN and MAN

It is an approach of allocating a single channel among multiple competing users through Frequency Division Multiplexing (FDM). If there are M users, the bandwidth is divided into M equal sized portions, each user being assigned one portion. Since,

each user has a private frequency band, there is no interface between users.

Space for learners

STOP TO CONSIDER

$$T=1/(U*C-L)$$

$$T(\text{FDM})=N*T(1/U(C/N)-L/N)$$

Where T=mean time delay,

C=Capacity of channel,

L=arrival rate of frames,

1/U=bits/frame,

N=number of sub channels,

T(FDM)=Frequency Division Multiplexing Time.

3.2.2 Dynamic Channel Allocation

Possible assumptions include:

1) Station Model: Assumes that each of N stations independently produce frames.

2) Single Channel Assumption: Here all stations are equivalent and can send and receive on that channel.

3) Collision Assumption: If two frames overlap in time-wise, then collision occurs. Any collision is an error and both frames must be re-transmitted.

4(a) Continuous Time: Frame transmission can begin at any instant. There is no master clock dividing time into discrete intervals.

4(b) Slotted Time: Time is divided into discrete intervals (slots). Frame transmissions always begin at the start of a slot.

5(a) Carrier Sense: Stations can tell if the channel is in use before trying to use it. If the channel is sensed as busy, no station will attempt to use it until it goes idle.

5(b) No Carrier Sense: Stations cannot sense the channel before trying to use it. They just go ahead and transmit. Only later they determine whether the transmission was successful.

A set of protocols are used in MAC layer which are presented in figure 3.2.

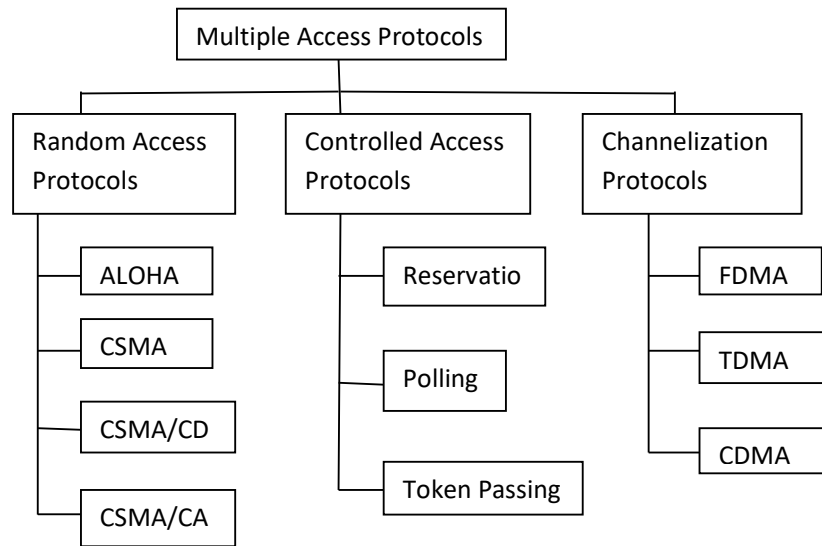
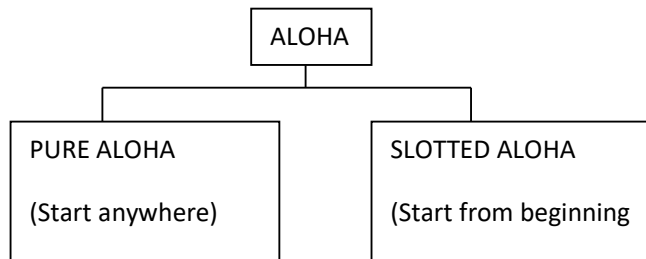

Figure 3.2 Classification of protocols in MAC layer

Space for learners

3.3 ALOHA



3.3.1 Pure ALOHA

The original ALOHA protocol is called pure ALOHA. This is simple but elegant protocol. The idea is that each station sends a frame whenever it has a frame to send. However, since there is only one channel to share, there is the possibility of collision between the frames from different stations. Figure 3.3 shows an example of frame collisions in pure ALOHA.

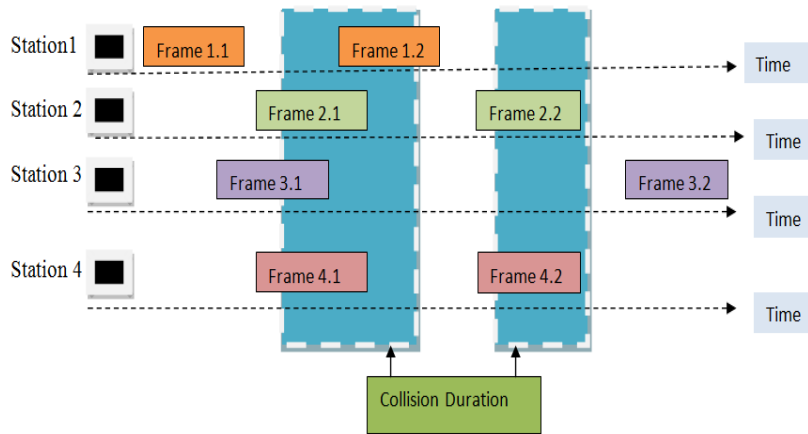

Figure 3.3: Frame collisions in a pure ALOHA network

There are four stations that contend with one another for access to the shared channel. The figure 3.3 shows that each station sends two frames; there are a total of eight frames on the shared medium. Some of these frames collide because multiple frames are in contention for the shared channel. Figure shows that only two frames survive: frame 1.1 from station1 and frames 3.2 from station 3. Even if one bit of frame coexists on the channel with one bit from another frame, there is a collision and both will be destroyed.

It is obvious that we need to resend the frames that have been destroyed during transmission. The pure ALOHA protocol relies on acknowledgments from the receiver. When a station sends a frame, it expects the receiver to send an acknowledgment. If the acknowledgment does not arrive after a time-out period, the station assumes that the frame (or the acknowledgment) has been destroyed and resends the frame.

A collision involves two or more stations. If all these stations try to resend their frames after the time-out, the frames will collide again. Pure ALOHA dictates that when the time-out period passes, each station waits a random amount of time before resending its frame. The randomness will help avoid more collisions. We call this time the back-off time T_B .

The Procedure of pure ALOHA protocol is depicted in figure 3.4.

Space for learners

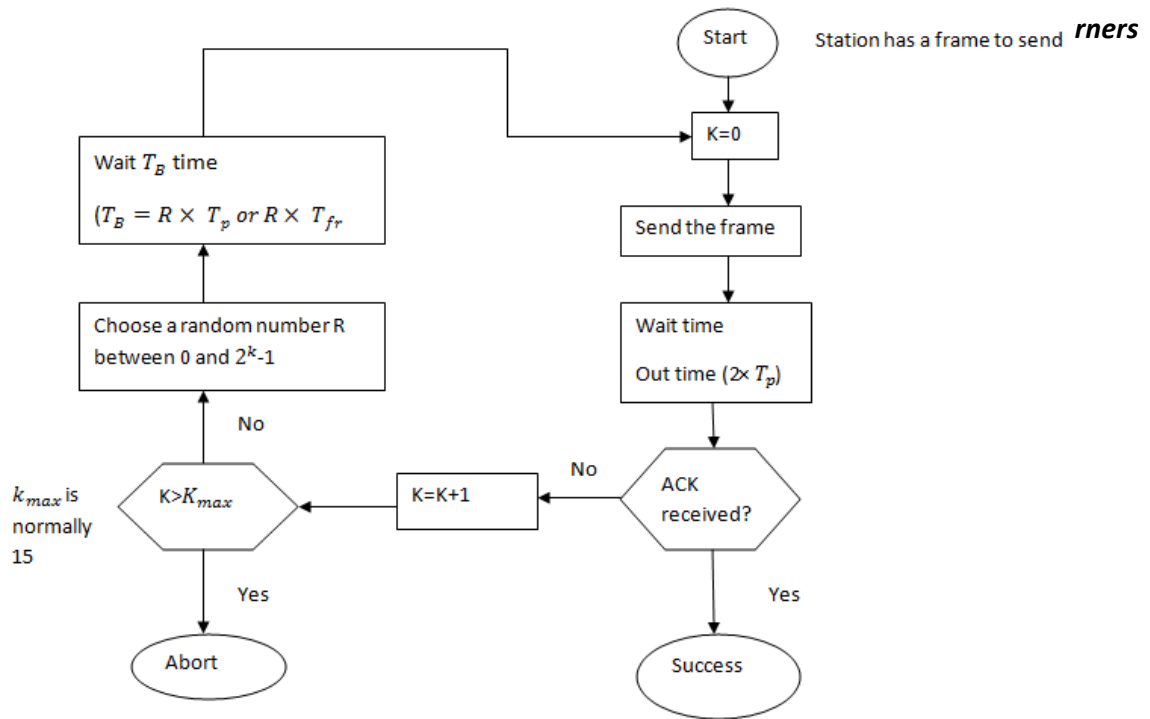

Figure 3.4: Procedure of pure ALOHA protocol

STOP TO CONSIDER

K: Number of attempts

T_p : Maximum propagation time

T_{fr} : Average transmission time for a frame

T_B : Back off time

Pure ALOHA vulnerable time = $2 \times T_{fr}$

The throughput for pure ALOHA is $S = G \times e^{-2G}$

The maximum throughput $S_{max} = 0.184$ when $G = (1/2)$

Problem 1: A pure ALOHA network transmits 200bit frames on a shared channel of 200 kbps. What is the throughput if the system (all stations together) produces?

- a) 1000 frames per second.
- b) 500 frames per second.
- c) 250 frames per second.

Solution: The frame transmission time is $200/200$ kbps or 1ms.

a) If the system creates 1000 frames per second, this is 1 frame per millisecond. The load is 1. In this case, $S=G \times e^{-2G}$ or $S=0.135$, here $G=1$.

b) If the system creates 500 frames per second, this is (1/2) frames per millisecond. The load is (1/2). In this case, $S=G \times e^{-2G}$ or $S=0.184$ (18.4%). This means that the throughput is $500 \times 0.184=92$ and that only 92 frames out of 500 will probably survive.

c) If the system creates 250 frames per second, this is (1/4) frame per millisecond. The load is (1/4). In this case, $S=G \times e^{-2G}$ or $S=0.152$ (15.2%). This means that the throughput is $250 \times 0.152=38$. Only 38 frames out of 250 will probably survive.

3.3.2 Slotted ALOHA

Pure ALOHA has a vulnerable time of $2 \times T_{fr}$. This is so because there is no rule that defines when the station can send. A station may send soon after another station has started or soon before another station has finished. Slotted ALOHA was invented to improve the efficiency of pure ALOHA.

In slotted ALOHA, we divide the time into slots of T_{fr} and force the station to send only at the beginning of the time slot. Figure 3.4 shows an example of frame collisions in slotted ALOHA.

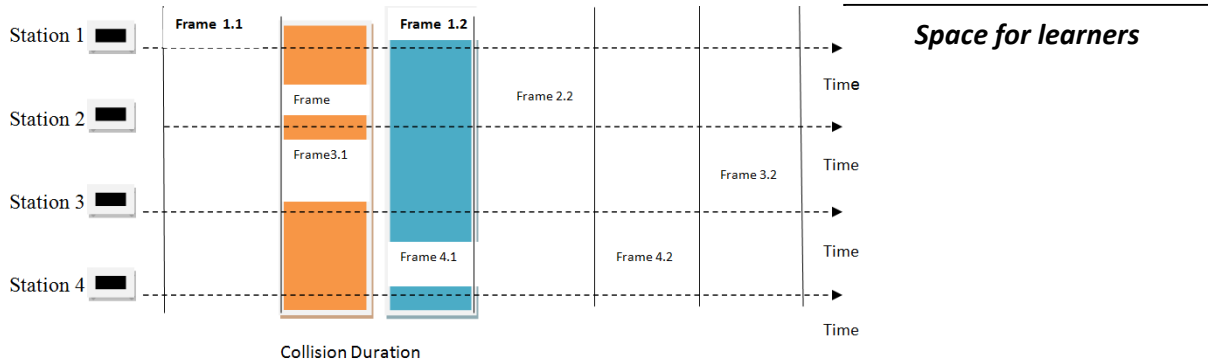

Figure 3.4 Frame collisions in slotted ALOHA

Because a station is allowed to send only at the beginning of the synchronized time slot, if a station misses this moment, it must wait until the beginning of the next time slot. This means that the station which started at the beginning of this slot has already finished sending its frame. But there is still the possibility of collisions if two stations try to send at the beginning of the same time slot. So, the vulnerable time is now reduced to one-half, equal to T_{fr} . Figure 3.4 shows the situation. Also it proves that the vulnerable time for slotted ALOHA is one-half that of pure ALOHA.

Slotted ALOHA vulnerable time = T_{fr}

The throughput for slotted ALOHA is $S = G \times e^{-G}$

The maximum throughput $S_{max} = 0.368$ when $G = 1$.

Problem 2: A slotted ALOHA network transmits 200-bit frames using a shared channel with a 200kbps bandwidth. Find the throughput if the system (all stations together) produces

- 1000 frames per second.
- 500 frames per second.
- 250 frames per second.

Solution: The frame transmission time is $200/200$ kbps or 1 ms.

a) In this case G is 1. So, $S = G \times e^{-G}$ or $S = 0.368$ (36.8%). This means that the throughput is $1000 \times 0.0368 = 368$ frames. Only 368 out of 1000 frames will probably survive.

Space for learners

b) Here G is $\frac{1}{2}$. In this case $S=G \times e^{-G}$ or $S = 0.303$ (30.3%). This means that the throughput is $500 \times 0.303 = 151$. Only 151 frames out of 500 will probably survive.

c) Now G is $\frac{1}{4}$. In this case $S=G \times e^{-G}$ or $S = 0.195$ (19.5%). This means that the throughput is $250 \times 0.195 = 49$. Only 49 frames out of 250 will probably survive.

Space for learners

CHECK YOUR PROGRESS - I

1. State whether true or false
 - a) MAC sub layer using broadcast networks and their protocol.
 - b) LLC is down layer of data link layer.
 - c) MAC layer is responsible for encapsulating frames.
 - d) ALOHA is a random access protocol.
2. Fill in the blanks:
 - a) In ALOHA, it starts anywhere.
 - b) ALOHA improves the efficiency of ALOHA

3.4. CARRIER SENSE MULTIPLE ACCESS (CSMA)

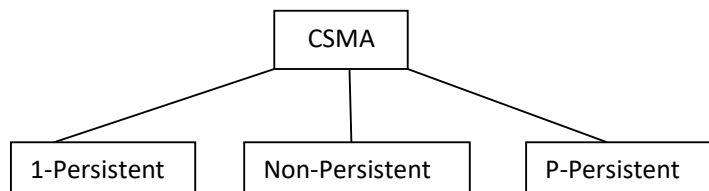

3.4.1 1-Persistent

The 1-persistent CSMA method is simple and straight forward. In this method, after the station finds the line idle, it sends its frame immediately (with probability 1). This method has the highest chance of collision because two or more stations may find the line idle and send their frames immediately.

3.4.2. Non-Persistent

In the non-persistent method, a station has a frame to send senses the line. If the line is idle, it waits a random amount of time and then senses the line again. The non-persistent approach reduces the chance of collision because it is unlikely that two or more stations will wait the same amount and retry to send simultaneously. However, this method reduces the efficiency of network because the medium remains idle when there may be stations with frames to send.

3.4.3 P-Persistent

The p-persistent method is used if the channel has time slots with slot duration equal to or greater than the maximum propagation time. The p-persistent approach combines the advantages of the other two strategies. It reduces the chance of collisions and improves efficiency. In this method, after the station finds the line idle it follows these steps:

1. With probability p , the station sends its frame.
2. With probability $q=1-p$, the station waits for the beginning of the next time slot and checks the line again.

Figure 3.5a, b, c presents the flow diagram for three persistence methods.

Space for learners

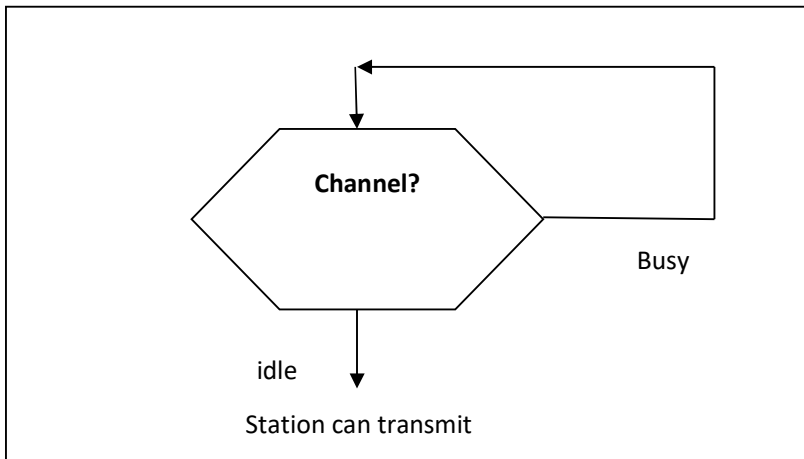

Figure 3.5 (a): Flow diagram of 1-Persistent CSMA

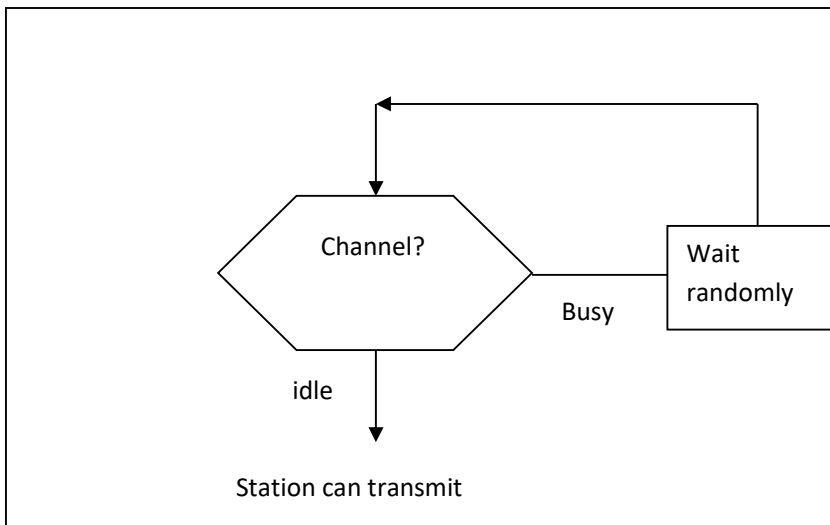

Figure 3.5 (b): Flow diagram of non-Persistent CSMA

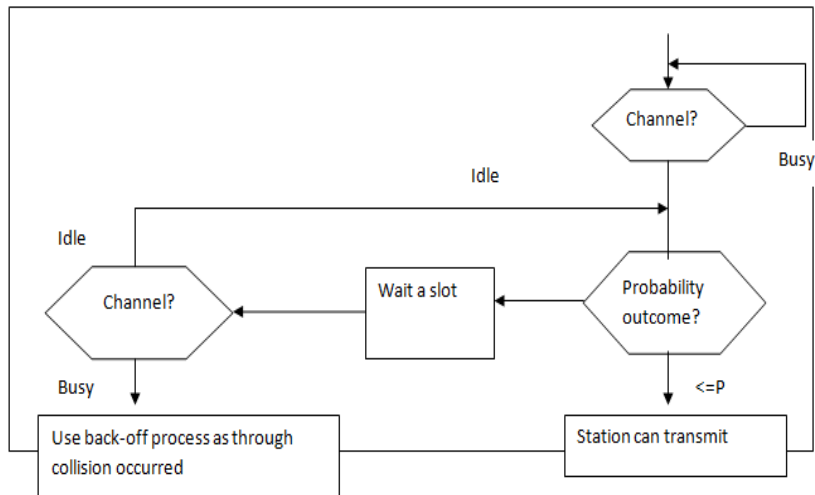

Figure 3.5 (c): Flow diagram of P-Persistent CSMA

Space for learners

3.5 CARRIER SENSE MULTIPLE ACCESS WITH COLLISION DETECTION (CSMA/CD)

- CSMA/CD helps the CSMA algorithm to handle collision.
- In this method, a station monitors the medium after it sends a frame to see transmission was successful. If so, station is finished. If there is a collision, the frame is sent again.
- For CSMA/CD to work, we need a restriction on the frame size. Before sending last bit of frame, the sending station must detect collision, if any, and abort transmission.
- This is so because once the entire frame is sent, station does not keep copy of it. Therefore, transmission time must be at least twice of maximum propagation time T_p .

Q) A network using CSMA/CD has a bandwidth of 10 Mbps. If the maximum propagation time is $25.6 \mu\text{s}$. What is minimum size of frame?

Solution:

$$\begin{aligned}
 m/B &\geq 2T_p \\
 &= m \geq 2 \times 25.6 \times 10^{-6} \times 10 \times 10^6 \\
 &= m \geq 512 \text{ bits or message size} = 64 \text{ bytes}
 \end{aligned}$$

3.6 CARRIER SENSE MULTIPLE ACCESS WITH COLLISION AVOIDANCE (CSMA/CA)

Collision detection using energy level is possible in case of wired medium. But in case of wireless medium, much of the sent energy is lost in transmission. Thus, energy level cannot be used for collision detection. So, we need to avoid collision on wireless because they cannot be detected.

CSMA avoids collision by using three strategies:

- 1) Interface Space, 2) the contention window and 3) Acknowledgement.

Q) Consider a CSMA/CD network that transmits data at rate of 100 Mbps over a 1 km cable with no repeaters. If minimum frame size required for this network is 1250 bytes. What is signal speed (km/sec) in the cable?

Solution: $T_t \geq 2 \times T_p$
 $m/B \geq 2d/V$
 $= 1250/100 \times 10^6 \geq 2 \times 1 \times 10^3 / V$
 $= V \leq 2 \times 10^3 \times 10 \times 10^6 / 1250 \times 8$
 $= V \leq 20000$

3.7 COLLISION FREE PROTOCOLS

Collisions can be avoided in CSMA/CD but they can still occur during the contention period. This affects the system performance, especially when the cable is long and the frames are short. Again, CSMA/CD is not universally applicable. Here, we shall discuss some protocols that resolve the collision during the contention period.

- 1) A Bit Map Protocol.
- 2) Binary Countdown.
- 3) Limited Contention Protocols.
- 4) Adaptive Tree Walk Protocol.

3.7.1 A Bit Map Protocol

It is our first collision free protocol; each contention period consists of exactly N slots. If station 0 has a frame to send, it transmits a 1bit during the zeroth slot. No other station is allowed to transmit during this slot. In this way, each station has complete knowledge of which station wishes to transmit. There will never be any collisions because everyone agrees on who goes next. Protocols like this which the desire to transmit is broadcasting for the actual transmission are called Reservation Protocols. Figure 3.6 presents a Bit Map protocol.

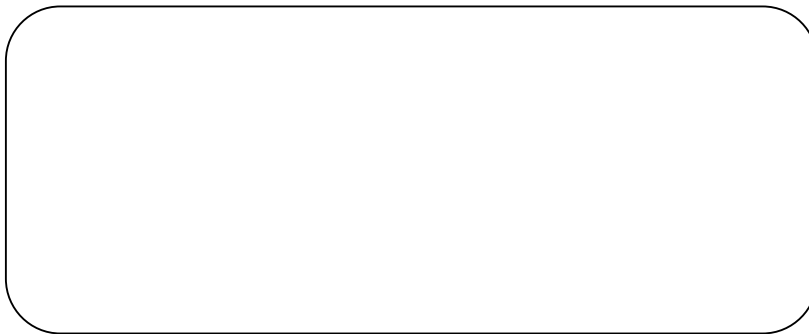

Figure 3.6: A Bit Map Protocol

For analysing the performance, we will measure time in units of the contention bit slot, with a data frame of d time units. Under low load conditions, this will simply repeat over and over for lack of data frames.

3.7.2 Binary Countdown

This protocol is used to overcome the overhead 1 bit per binary station. Here, binary station addresses are used. All addresses are assumed of the same length. All the station at first broadcast their most significant address bit that I 0,1,1,1 respectively. The most significant bits are ORed together. Binary Countdown protocol is shown in figure 3.7.

Station 0001 sees the 1 MSB in another station addresses. Other three stations 1001, 1100, 1011 continue. The next bit is at station

Space for learners

1100; swiss station 1011 and 1001 give up. Then station 1100 starts transmitting a frame, after which bidding cycle starts.

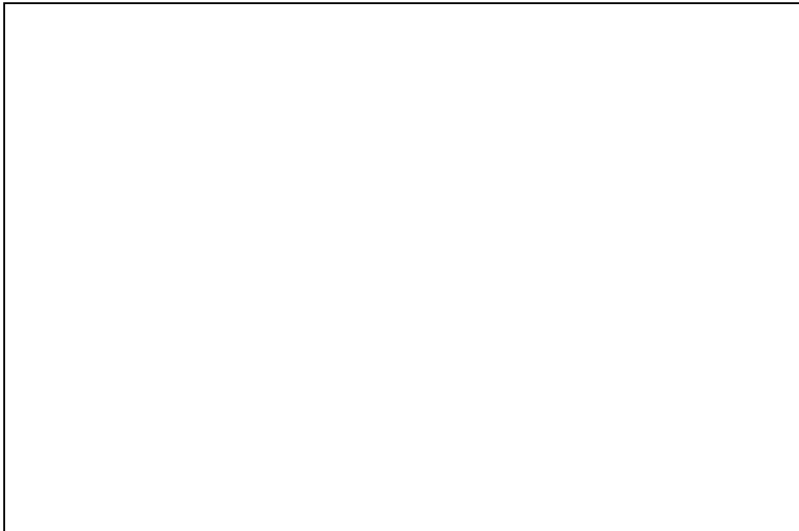

Figure 3.7: Binary Countdown

Space for learners

3.7.3 Limited Contention Protocols

- Collision based protocols (pure and slotted ALOHA, CSMA/CD) are good when the network load is low.
- Collision free protocols (bitmap, binary countdown) are good when load is high.
- When combining their advantages
 1. Behave like the ALOHA scheme under light load.
 2. Behave like the bitmap scheme under heavy load.

3.7.4 Adaptive Tree Walk Protocol

- Partition the group of station and limit the contention for each slot.
- Under light load, everyone can try for each slot like ALOHA.
- Under heavy load, only a group can try for each slot.
- How do we do it:
 1. Treat every station as the leaf of a binary tree.

2. First slot (after successful transmission), all station can try to get the slot (under the root node).
3. If no conflict, fine.
4. In case of conflict, only nodes under a sub tree get to try for the next one (depth first search).

Space for learners

3.8 WAVELENGTH DIVISION MULTIPLE ACCESS PROTOCOLS

It is a technique of multiplexing multiple optical carrier signals through a single optical fiber channel by varying the wavelengths. It allows communication in both the directions in the fiber cable. Here, the optical signals from different sources are combined so that their wavelengths are different.

The combined signal is transmitted via a single optical fiber strand. At the receiving end, a demultiplexer splits the incoming beam into its components and each of the beams is sent to the corresponding receivers.

Based upon the wavelength, it can be divided into two categories-

1. Course WDM (CWDM) and
2. Dense WDM (DWDM)

CHECK YOUR PROGRESS - II

1. Choose the correct one:
 - a) 1-Persistent/ Non-Persistent/ P-Persistent method has the highest chance of collisions.
 - b) 1-Persistent/ Non-Persistent/ P-Persistent method has the lowest chance of collisions.
 - c) CSMA avoids collision using two/three/four strategies.
 - d) A bit map/ Limited Contention Protocols behave like the ALOHA Scheme under light load and bitmap scheme under heavy load.

3.9. SUMMING UP

- MAC sub layer deals with broadcast networks and their protocols. It is also known as **Media Access Control Protocol**.
- In channel allocation, single channel is divided and allotted to multiple users. It can be solved by two schemes- **static** and **dynamic** channel allocation.
- ALOHA is divided into two parts- **Pure ALOHA** and **Slotted ALOHA**. In pure ALOHA, we can start anywhere but in case of slotted ALOHA, we can start from beginning.
- Carrier sense multiple access protocol is divided into three parts- **1-persistent, non-persistent** and **p-persistent**.
- CSMA/CD helps the CSMA algorithm to **handle collision**.
- CSMA/CA avoids collisions using **three** strategies: **interface space, the contention window** and **acknowledgement**.
- Some protocols resolve collisions during the contention period. They are a **bit map protocol, binary countdown, limited contention protocols** and **adaptive tree walk protocol**.

3.10 ANSWERS TO CHECK YOUR PROGRESS

Check Your Progress 1:

1)

a) True, b) False, c) True, d) True

2)

a) Pure ALOHA, b) Slotted ALOHA, Pure ALOHA

Check Your Progress 2:

1)

a) 1-Persistent, b) P-Persistent, c) two, d) Limited Contention Protocols

Space for learners

3.11 POSSIBLE QUESTIONS

Space for learners

Short Answer Type Questions:

1. What is MAC Sub Layer?
2. What is ALOHA?
3. What are the types of ALOHA?
4. What is CSMA?
5. What are the different types of CSMA?
6. What are the collision free protocols?

Long Answer Type Questions:

1. Define MAC Sub Layer. What are the various functions of MAC Sub Layer?
2. What are the difference between the MAC sub layer and LLC sub layer?
3. What is the channel allocation problem? How can we solve this problem?
4. What are the basic assumptions in dynamic channel allocation?
5. Define ALOHA. What is its type? Differentiate between pure and slotted ALOHA.
6. Discuss pure ALOHA with example.
7. Define slotted ALOHA with example.
8. Define different types of CSMA.
9. What are the different types of collision free protocols? Briefly explain.
10. Write short notes on
 - a) CSMA/CD
 - b) CSMA/CA
 - c) Wavelength Division Multiple Access Protocols.

3.12 REFERENCES AND SUGGESTED READINGS

- Computer Network, Fourth Edition, Andrew S. Tanenbaum

UNIT 4: LOCAL AREA NETWORK (LAN)

Unit Structure:

- 4.1 Introduction
- 4.2 Unit Objectives
- 4.3 Ethernet cabling
 - 4.3.1 10 base 5
 - 4.3.2 10 base 2
 - 4.3.3 10 base T
 - 4.3.4 10 base-F
- 4.4 Hubs
- 4.5 Patch Panels
- 4.6 Wiring Closet
- 4.7 Manchester Encoding
- 4.8 MAC Sub-Layer Protocol
- 4.9 Ethernet Performance
- 4.10 Switched Ethernet
- 4.11 FDDI
- 4.12 Fiber Channel
 - 4.12.1 Point-to-Point
 - 4.12.2 Arbitrated Loop
 - 4.12.3 Switched Fabric (FC-SW).
- 4.13 Fast Ethernet
 - 4.13.1 100 BASE-T4
 - 4.13.2 100 BASE-TX
 - 4.13.3 100 BASE-T4
 - 4.13.4 Gigabit Ethernet
- 4.14 Summing up
- 4.15 Answers to Check Your Progress
- 4.16 Possible Questions
- 4.17 References and Suggested Readings

4.1 INTRODUCTION

A *local-area network (LAN)* is a computer network that covers a relatively small geographical area, typically confined to a single building premises. Most of the LANs connect Workstations and Personal Computers where each station has its own CPU and programs for sharing of resources. LANs are capable of transmitting data at very fast rates, much faster than data can be transmitted over a telephone line. Schematic diagram of Lan is shown in figure 4.1.

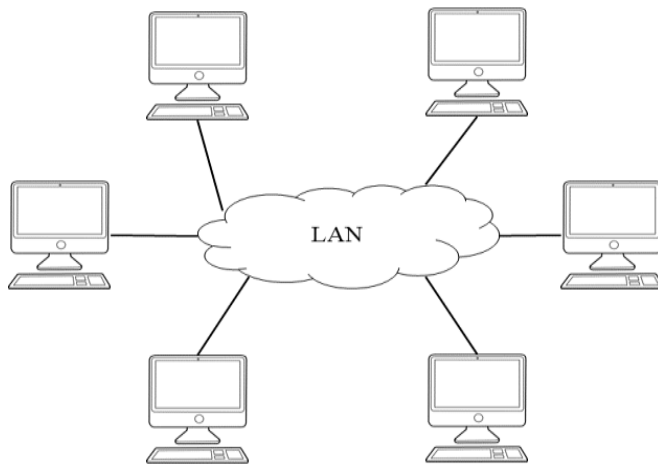

Figure 4.1: Local Area Network

LAN can be connected to other LANs over any distance via telephone lines and radio waves. A system of LANs connected in this way is called a wide-area network (WAN). The difference between a LAN and WAN is that the wide-area network spans a relatively large geographical area. LAN requires Ethernet cables and Layer 2 switches.

4.2 UNIT OBJECTIVES

After going through this unit, you will be able to -

- understand the basic concepts of LAN
- Know different types of Ethernet Cablings and frame format
- Get the working mechanism of Hubs and switches
- design wiring closets and patch panels

- learn Data encoding Techniques
- understand Fast and gigabit Ethernet

4.3 ETHERNET CABLING

IEEE has standardized local area networks under the name project IEEE 802. The most important LAN standards are IEEE 802.3 Ethernet and IEEE 802.11 (wireless LAN) where both the standards have different physical layers and different MAC sub-layers.

The name "Ethernet" is meaning cables. There is wide variety of options available for the physical medium to be used in 10 Mbps specification for IEEE 802.3 (Ethernet).

There is a concise notation:

<Data rate in Mbps><signaling method><maximum segment length in hundreds>

The standard specifications of Ethernet are:

10 BASE 5

10 BASE 2

10 BASE-T

10 BASE-F

4.3.1 10 BASE 5

10Base5 cabling, popularly called thick Ethernet, was introduced first. Connections to it are generally made using vampire taps, in which a pin is very carefully forced halfway into the coaxial (RG-58) cable's score. The notation 10Base5 means that it operates at 10 Mbps, uses baseband signaling, and can support segments of up to 500 meters.

4.3.2 10 BASE 2

The second cable type is 10Base2, or thin Ethernet. Connections to it are made using industry-standard BNC connectors to form T junctions, rather than using vampire taps. BNC connectors are easier to use and more reliable. Thin Ethernet is much cheaper and easier

to install, but it can run for only 185 meters per segment, each of which can handle only 30 machines

4.3.3 10 BASE-T

10BASE-T has a maximum segment length of 100m and has a 10Mbps data transmission speed. 10BASE-T can use Category 3, 4, or 5 unshielded twisted-pair (UTP) or shielded twisted-pair (STP) cables for connectivity. Computers are connected through these cables to a central hub. With 10Base-T, there is no shared cable at all. Adding or removing a station is simpler in this configuration, and cable breaks can be detected easily. The disadvantage of 10Base-T is that the maximum cable run from the hub is only 100 meters, maybe 200 meters if very highquality category 5 twisted pairs are used.

4.2.4 10 BASE-F

10BASE-F type uses fiber optics cable. This alternative is expensive due to the cost of the connectors and terminators, but it has excellent noise immunity and is the method of choice when running between buildings or widely-separated hubs. Runs from the hub up to km are allowed. It also offers good security since wiretapping fiber is much more difficult than wiretapping copper wire.

Summary of IEEE 802.3 10 Mbps Ethernet Characteristics

Standard	Cable	Maximum Distance	Connector Used
10BASE-2	Thin Coax	185m	BNC
10BASE-5	Thick Coax	500m	BNC
10BASE-T	Twisted Pair	100m	RJ-45
10BASE-FL	Fiber optics	Up to 2km	SC or ST

4.3 HUBS

An Ethernet hub or simply a hub is a network device for connecting Ethernet devices together to act as a single network segment. Hub comprises of multiple input/output (I/O) ports. The connection of nodes to a hub is shown in figure 4.2. A device which has to be connected to the LAN is plugged in to one of these ports. When a data frame arrives at one port, it is relayed to every other port, without considering whether it is destined for a particular destination or not. If two frames arrive at the same time, they will collide, just as on a coaxial cable. In other words, the entire hub forms a single collision domain. Hub is just a central meeting point of all devices present in the network. Hub does not have any intelligence i.e.it does not examine the 802 addresses or use them in any way.

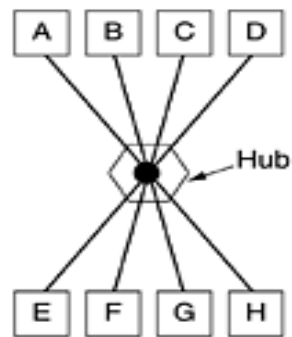

Figure 4.2: Hub

There are three types of network hubs: passive, active, and intelligent.

Passive Hubs do not amplify or regenerate any incoming signals before sending them to the LAN. Passive hubs are connected to other devices in a star configuration.

Active Hubs amplify the incoming electrical signals. If the signal is too weak for rebroadcasting, active hubs apply retiming and resynchronization techniques.

Intelligent Hubs work like active hubs and include the facility of remote management. They also provide flexible data rates to network devices.

A hub works at the physical layer (layer 1) of the OSI model. Hubs are now largely obsolete, having been replaced by network switches.

4.4 PATCH PANELS

A patch panel is hardware unit with multiple ports that helps organize a group of cables. A patch panel used in a LAN is a mounted hardware assembly that contains ports used to connect and manage incoming and outgoing LAN cables. Each of these ports contains a wire that goes to a different location. Patch panels can be small having just a few ports, or very large with many hundreds of ports. They can also be set up for, cat5 cables, RJ45 cables, fiber optic cables and many types. Figure 4.3 depicts a patch panel connections.

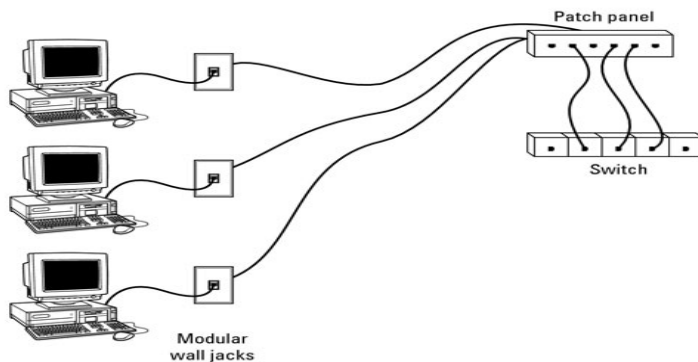

Figure 4.3: Patch Panel

The idea of Patch panels is to connect various IT devices together in an organized manner. They are in many different environments including communications closets, telephone company central offices, and data centers. Each port in a patch panel goes to a different device somewhere in the installation.

4.5 WIRING CLOSEST

Wiring closet is also known as an equipment room or server room. It is a dedicated room on the floor of a building that contains hubs, switches, and any other network components. While they are used for many purposes, their primary use is for computer networking where it may be called a premise wire distribution room (PWD room). Equipment that may be found in a wiring closet includes: Alarm systems, Circuit breaker panels, Video systems, such as cable TV and closed-circuit television systems, Ethernet routers, Network switches, Firewalls, Fiber optic terminations, Patch panels, Wireless access points etc. A wiring closet is presented in figure 4.4.

While planning a wiring closet, it is important that the control panel fronts are kept safely which are within easy reach and if necessary, the panels should be mounted on the walls. It is to be ensured that adequate ventilation facilities are provisioned in the wiring closets. It should be designed in such a way that the operators have easy access to both front and rear of all equipment.

Figure 4.4: Wiring Closet

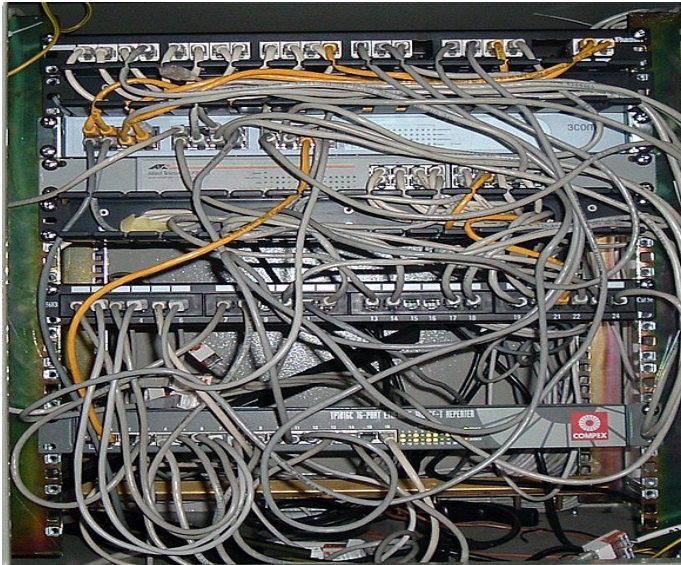

4.6 MANCHESTER ENCODING

Manchester encoding is a synchronous clock-encoding technique used by the physical layer to encode the clock and data of a synchronous bit stream. In this technique, the actual binary data to be transmitted over the physical media are not sent as a sequence of logic 1s and 0s (known as Non Return to Zero (NRZ)). Instead, the bits are converted into a slightly different format.

In Manchester encoding a binary 0 (zero) is indicated by a 1 to 0 transition in the middle of the bit and a binary 1 is indicated by a 0 to 1 transition in the middle of the bit. The signal transitions do not always occur at the *bit boundaries* (the division between one bit and another), but that there is *always* a transition in the middle of each bit.

The following diagram i.e. figure 4.5 shows a typical Manchester encoded signal with the corresponding binary representation of the data (0100110100) being sent.

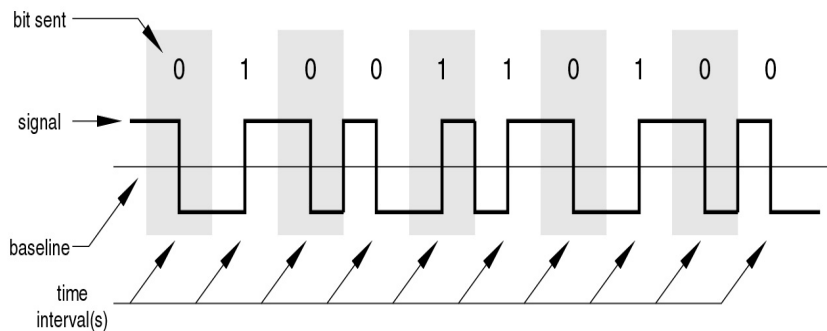

Figure 4.5: Encoding of Signal in Manchester Encoding

Advantage: DC component of the signal carries no information which makes it possible that standards that usually do not carry power can transmit this information.

Drawback: It requires more bandwidth than other encoding techniques.

4.7 MAC SUB-LAYER PROTOCOL

Media access control (MAC) protocols specifies how multiple devices access to a shared media network. The protocols used to determine who goes next on a multi access channel belong to a sub layer of the data link layer called the MAC (Medium Access Control) sublayer. Carrier sense multiple access/collision detection (CSMA/CD) is the most used contention-based MAC protocol, used in Ethernet networks. The channel access protocols are discussed in details in another part of the Syllabus.

4.7.1 IEEE 802.3 (Ethernet) Frame Format

Total basic frame format which is required for all MAC implementation is defined in **IEEE 802.3 standard**. The Ethernet frame contains seven fields: preamble, SFD, DA, SA, Length or Type field, upper-layer data, and the CRC. The format of the MAC frame is shown in figure 4.6.

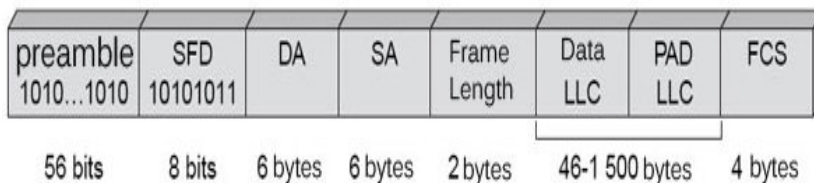

Figure 4.6: Ethernet Frame format

The frame starts with Preamble and SFD which are added by the Physical layer.

- **Preamble:** The first field of the 802.3 frame contains 7 bytes (56 bits) of alternating 0s and 1s that alerts the receiving system to the coming frame and enables it to synchronize its input timing. PRE (Preamble) was introduced to allow for the loss of a few bits due to signal delays.
- **Start Frame Delimiter (SFD):** The second field (1 byte: 10101011) signals the beginning of the frame. The last 2 bits is 11 and alerts the receiver that the next field is the destination address. The SFD warns station or stations that this is the last chance for synchronization.

- **Destination address (DA):** The DA field is 6 byte containing the physical address of the destination station or stations to receive the packets.
- **Source address (SA):** The SA field is also 6 byte and contains the physical address of the sender of the packet.
- **Length or Type:** This field is defined as a type field or length field. This is a 2-Byte field, which indicates the length of entire Ethernet frame. This 16-bit field can hold the length value between 0 to 65534, but length cannot be larger than 1500 because of some own limitations of Ethernet.
- **Data:** This is the place where actual data is inserted, also known as **Payload**. Both IP header and data will be inserted here if Internet Protocol is used over Ethernet. The maximum data present may be as long as 1500 Bytes. In case data length is less than minimum length i.e. 46 bytes, then padding 0's is added to meet the minimum possible length.
- **CRC:** CRC is 4 Byte field. This field contains a 32-bits hash code of data, which is generated over the Destination Address, Source Address, Length, and Data field. If the checksum computed by destination is not the same as sent checksum value, data received is corrupted

KEY NOTE:

The maximum data limit was chosen somewhat arbitrarily at the time the DIX standard was cast in stone, mostly based on the fact that a transceiver needs enough RAM to hold an entire frame and RAM was expensive in 1978. A larger upper limit would have meant more RAM, hence a more expensive transceiver.

In addition to there being a maximum frame length, there is also a minimum frame length. While a data field of 0 bytes is sometimes useful, it causes a problem. When a transceiver detects a collision, it truncates the current frame, which means that stray bits and pieces of frames appear on the cable all the time. Ethernet requires that valid frames must be at least 64 bytes.

STOP TO CONSIDER

- Preamble and SFD are not part of Ethernet Frame; but added by the Physical Layer.
- Maximum Frame Length is 1500+18=1518 Bytes
- Minimum Frame Length is 46 + 18=64 Bytes
where 18Bytes are calculated as :
DA (6 Bytes)+SA(6 Bytes) +Frame Length(2 Bytes)+FCS/CRC(4 Bytes)=18 Bytes

4.8 ETHERNET PERFORMANCE

Now let us analyze the performance of Ethernet under conditions of heavy and constant load. Assume k stations are always ready to transmit with probability p during each contention slot. Let A be the probability that some station acquires the channel. A is calculated as:

$$A = kp(1-p)^{kp}$$

The value of A is maximized at $p = 1/k$. If there are innumerable stations connected to the Ethernet network, i.e. $k \rightarrow \infty$, the maximum value of A will be $1/e$.

Let Q be the probability that the contention period has exactly j slots. Q is calculated as –

$$Q = A(1-A)^{j-1}$$

Let M be the mean number of slots per contention. So, the value of M will be –

$$M = \sum_{j=0}^{\infty} jA(1-A)^{j-1} = \frac{1}{A}$$

Given that τ is the propagation time, each slot has duration 2τ . Hence, the mean contention interval, w will be $2\tau/A$.

Let P be the time in seconds for a frame to propagate.

The channel efficiency, when a number of stations want to send frame, can be

calculated as –
$$\text{Channel Efficiency} = \frac{P}{P + 2\tau/A}$$

Let F be the length

of frame, B be the cable length, L be the cable length, c be the speed of signal propagation and e be the contention slots per frame.

The channel efficiency in terms of these parameters is –

$$\text{Channel Efficiency} = \frac{1}{1 + 2BLE/cF}$$

4.9 SWITCHED ETHERNET

Ethernet is classified into two categories: classic Ethernet and switched Ethernet. Where legacy Ethernet networks transmitted data at 10 megabits per second (Mbps), modern Ethernet networks can operate at 100Mbps, 1,000 Mbps or even more due to the use of **switched Ethernet** which is shown in figure 4.7. The first Ethernet cross-connecting devices were "hubs" that share the total bandwidth. However, the switch treats each send-receive pair at full speed, and most all hubs have been replaced with switches. Switched networks replace the shared medium of legacy Ethernet with a dedicated segment for each station. These segments connect to a switch, which acts much like an Ethernet bridge, but can connect many of these single station segments.

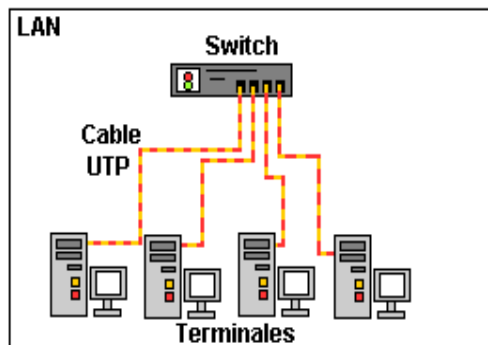

Figure 4.7: Switched Ethernet

The switch connects the high-speed backplane bus to all the stations in the LAN. The switch-box contains a number of ports, typically within the range of 4 – 48. Connections from a backbone Ethernet switch can go to computers, peripherals or other Ethernet switches and Ethernet hubs.

4.10 FDDI

Fiber Distributed Data Interface, or FDDI, is a high-speed network technology developed in the early 1980s by the American National Standards Institute (ANSI) for operating at speeds up to 100 Mbps over fiber-optic cabling that is often used for network backbones in a local area network (LAN) or Metropolitan Area Network (MAN). The FDDI network is set up in a ring topology fashion having two rings: a primary ring and a secondary ring, each is able to carry 100Mbps. FDDI makes use of the same token-passing scheme as the IEEE 802.5 Token Ring network to control transmission around the loop. Following are the two types of devices used in FDDI standard: one is end user stations and the second one is concentrators which connect the Single Attached Systems (SAS) to the FDDI ring. FDDI LAN is presented in figure 4.8.

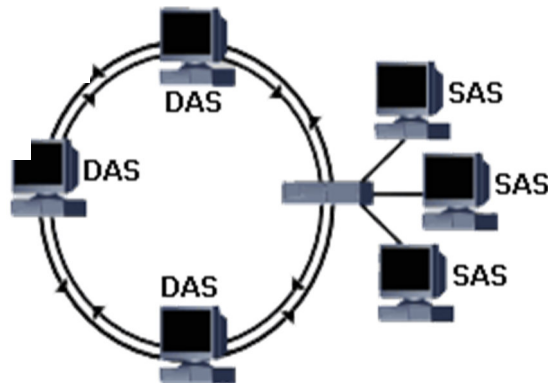

Figure: 4.8 FDDI LAN

The FDDI standard defines three ways of connecting devices to the ring:

- **Single Attached Systems (SAS):** These devices cannot connect directly to FDDI dual ring since they have a single port, to connect these device to the FDDI network a concentrator is used.
- **Dual Attached Systems (DAS):** All stations connected to the FDDI dual ring must be dual attached and always be up and running. For stations that cannot be connected using DAS methodology can use a SAS which uses a concentrator.

- **Dual Homing:** Some devices may connect to two concentrators using a DAS card for redundancy purposes. One link will be active and the other link will take the active role if the active links fails.

FDDI can handle data rates upto 100 mbps and provides good security because of Fiber Technology as eavesdrop on fiber optic link is quite difficult and the cable is not breakable like any other media types. Fiber optic Cable can transmit signal to long distances upto 200 kms and it is immune to the Electro Magnetic Interferences. FDDI can isolate faulty nodes with use of wiring concentrators for instantaneous re-routing. Wiring concentrators function as centralized cabling connection devices for workstations. FDDI is relatively more complex system than other systems because of its installation and maintenance issues which requires great deal of expertise.

4.11 FIBER CHANNEL

Fiber Channel (FC) is a high-speed data transfer protocol providing in-order, lossless delivery of raw block data. It is a serial I/O interconnect network technology capable of supporting multiple protocols. It is used primarily for storage area networks (SANs). Fiber Channel technology handles high-performance disk storage for applications on many corporate networks, and it supports data backups, clustering, and replication. The original version of Fiber Channel operated at a maximum data rate of 1 Gbps. Newer versions of the standard increased this rate up to 128 Gbps, with 8, 16, and 32 Gbps versions also in use. The FC SAN physical components such as network cables network adapters and hubs or switches can be used to design a Fiber channel SAN. The different types of FC architecture which can be designed are:

- Point-to-point
- Fiber channel arbitrated loop (FC-AL)
- Fiber channel switched fabric (FC-SW).

4.11.1 Port types in FC

The ports in a switched fabric can be one of the following types:

N_Port: It is an end point in the fabric. It is a computer system port (FC HBA port) or a storage system port that is connected to a switch in a switched fabric.

E_Port: It is a port that forms the connection between two Fiber Channel switches. The E_Port on an FC switch connects to the E_Port of another FC switch in the fabric ISLs.

F_Port: It is a port on a switch that connects an N_Port.

G_Port: It is a generic port on a switch that can operate as an E_Port or an F_Port and determines its functionality automatically during initialization.

There are various topologies defined for fiber channel with regard to application and installation requirements. Each of these topologies exhibit different performance characteristics.

4.11.2 Point-to-Point

Point-to-Point topology is the most basic and simple Fiber Channel topology amongst all. Here two devices are directly connected by a Fiber Channel cable. In general, it has been used to connect RAID (Redundant Array of Independent Disks) and other storage subsystems to servers in server-centric computing environments. Figure 4.9 depicts Point-to-Point topology.

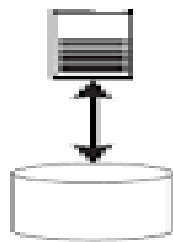

Figure 4.9: Point-to point

4.11.3 Arbitrated Loop

The arbitrated loop, also known as FC-AL, is a Fiber Channel topology in which devices are connected in a one-way loop fashion in a ring topology. It was a cost-effective alternative to

a fabric topology. FC-AL uses fiber optic cabling and copper wires to produce a maximum (burst) data transfer rate of more than 100 MB/sec. FC-AL is capable of supporting up to 127 devices as far as 10 kilometers away, thus opening a new perspective for remote data storage (web storage and storage networking).

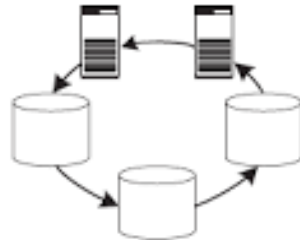

Figure 4.10: Arbitrated Loop

This topology is usually used to connect disk drives to RAID controllers or host bus adapters (HBA). Arbitrated loop topology is shown in figure 4.10.

4.11.3 Switched Fabric

Switched fabric or switching fabric is a network topology in which network nodes interconnect via one or more network switches (particularly crossbar switches). Because a switched fabric network spreads network traffic across multiple physical links, it yields higher total throughput than broadcast networks, such as the early 10BASE5 version of Ethernet and most wireless networks such as Wi-Fi. It essentially consists of one or more switches, controlling a large amount of port-to-port transfers of data and commands between nodes. A schematic diagram of Switched Fabric is shown in figure 4.11.

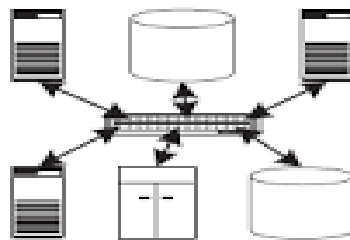

Figure 4.11: Switched Fabric

Fiber Channel networks have a historical reputation for being expensive to build, difficult to manage, and inflexible to upgrade due to incompatibilities between vendor products.

4.12 FAST ETHERNET

It is the Successor of 10-Base-T Ethernet. It is more popular than Gigabit Ethernet because its configuration and implementation is simple. There are several versions of 100 Mbps Ethernet and these are designated using the 100BASE-xx configuration where 100 indicates the speed in Mbps, Base indicates it is Baseband and the suffix indicates the medium either fiber cable or copper. It is faster than its successors. Its variants are:

4.12.1 100 BASE-T4

This is the early implementation of Fast Ethernet over twisted pair cables, carrying data traffic at 100 Mbps. It uses four pairs of category-3 UTP cable. Two of the four pairs are bi-directional, the other two are unidirectional. In each direction, three pairs are used at the same time to carry data. Encoding/decoding in 100Base-T4 is more complicated. As it uses category 3 UTP, each twisted pair cannot easily handle more than 25 Mbaud data.

4.12.2 100BASE-TX

100BASE-TX is the technical name of Fast Ethernet over twisted pair cables. This has either two pairs of unshielded twisted pairs (UTP) category 5 wires or two shielded twisted pairs (STP) type 1 wires to connect a station to the hub. Each network segment can have maximum length of 100m. Straight binary coding is not used; instead, a scheme called 4B/5B is used. The 100Base-TX system is full duplex; stations can transmit at 100 Mbps and receive at 100 Mbps at the same time.

4.12.3 100BASE-FX

100BASE-FX is the technical name of Fast Ethernet over fiber optic cables. It is a version of Fast Ethernet carrying data traffic at 100

Mbps. This has two pairs of optical fibers. One pair transmits frames from hub to the device and the other from device to hub. Maximum distance between hub and station is 2000m. It has a data rate of 125 Mbps. In most Fast Ethernet applications, fiber optics is used for the long-haul transmissions. In addition, the distance between a station and the hub can be up to 2 km.

Summary of IEEE 802.3 100 Mbps Ethernet Characteristics

Standard	Cable Type	Maximum Distance	Connector Used
100BaseT4	Category 3, 4, or 5 UTP or STP	100m	RJ-45
100BaseTX	Category 5 UTP or STP	100m	RJ-45
100BaseFX	Fiber-optic	412m with half-duplex 10,000m with full-duplex fiber	SC or ST

4.13 GIGABIT ETHERNET

The emergence of Gigabit Ethernet has been purely to increase the Ethernet performance while maintaining all Ethernet standards. Gigabit Ethernet supports two different modes of operation: full-duplex mode and half-duplex mode. Full-duplex mode allows traffic in two directions at the same time. When a central switch connected to computers on the periphery; this mode is used. A half-duplex mode is used when computers are connected to a hub rather than a switch. A hub does not buffer incoming frames. All the lines are electrically connected internally, simulating the multi-drop cable used in classic Ethernet. Standard CSMA/CD protocol is required in this mode because collisions are possible. Because a 64-byte frame can now be transmitted 100 times faster than in classic Ethernet, the maximum cable length must be 100 times less or 25 meters.

Gigabit Ethernet supports both copper and fiber cabling. Signaling at or near 1 Gbps over fiber means that the light source has to be turned on and off in under 1 ns. LEDs simply cannot operate this fast, so lasers are required. Two wavelengths are permitted: 0.85 microns (Short) and 1.3 microns (Long). Lasers at 0.85 microns are cheaper but do not work on single-mode fiber.

Summary of IEEE 802.3 1000 Mbps Ethernet Characteristics

Standard	Cable Type	Maximum Distance	Connector Used
1000BaseSX	MM fiber-optic	550m	SC or ST
1000BaseLX	Fiber cable	5000m	SC or ST
1000BaseCX	Shielded copper wire	25m	9-pin shielded connector

CHECK YOUR PROGRESS

Fill in the Blanks

1. The Full form of MAN is -----
2. The maximum length of a cable segment in 100BaseTX standard is -----meter.
3. The maximum and minimum size of data in IEEE 802.3 Ether Frame is-----bytes and -----bytes respectively.
4. The Full form of NRZ is-----
5. The maximum length of a cable segment in 10Base5 standard is -----meter

4.14 SUMMING UP

- IEEE has standardized a number of local area networks under the name project IEEE 802. The most important LAN standards are IEEE 802.3 Ethernet (Wired Network) and IEEE 802.11 (wireless LAN).

- An Ethernet hub or simply a hub is a network device for connecting **Ethernet** devices together to act as a single network segment. Hub comprises of multiple **input/output (I/O)** ports. There are three types of network hubs: passive, active, and intelligent.
- A patch panel is hardware unit with multiple ports that helps organize a group of cables. A patch panel in a local area network (**LAN**) is a mounted hardware assembly that contains **ports** used to connect and manage incoming and outgoing LAN cables.
- In Manchester encoding, a binary 0 (zero) is indicated by a 1 to 0 transition in the middle of the bit and a binary 1 is indicated by a 0 to 1 transition in the middle of the bit. it requires more bandwidth than other encoding techniques.
- Ethernet Frame has minimum size of 64 bytes and maximum of 1500 bytes.
- Ethernet is classified into two categories: classic Ethernet and switched Ethernet. Where legacy Ethernet networks transmitted data at 10 **megabits** per second (Mbps), modern Ethernet networks can operate at 100Mbps, 1,000 Mbps or even more due to use of switched Ethernet
- The FDDI network is set up in a ring topology fashion. FDDI can handle data rates upto 100 mbps.
- Fiber Channel (FC) is a high-speed data transfer protocol capable of supporting multiple protocols. It is used primarily for storage area networks (SANs). The different types of FC architecture which can be designed are -Point-to-point Fibre channel arbitrated loop (FC-AL) and Fiber channel switched fabric (FC-SW)
- Gigabit Ethernet supports both copper and fiber cabling. Signaling at or near 1 Gbps over fiber.

4.15 ANSWERS TO CHECK YOUR PROGRESS

1. Metropolitan Area Network

2. 100

3. 46 and 1500

4. Non Return To Zero

5. 550

4.16 POSSIBLE QUESTIONS

Short Answer type Questions:

1. What is LAN and MAN?
2. What is Ethernet? What is Fast and Gigabit Ethernet?
2. Explain the characteristics of IEEE 802.3 100 Mbps Ethernet standard.
3. Explain the characteristics of IEEE 802.3 1000 Mbps Ethernet standard.
4. What is Fiber Channel?
5. What is Patch Panel?
6. What is Thick and thin Ethernet?
7. What is Preamble and SFD in Ethernet Frame?
8. What is Switched network and its Advantages?
9. What is MAC?
10. What is the major Drawback of Manchester Encoding Technique?

Long Answer type Questions:

1. What is FDDI? Explain SAS and DAS.
2. Explain the Frame format of IEEE 802.3 Ethernet standard.
3. Explain the Manchester Encoding of a signal with a suitable representation of binary data. What are the advantages and disadvantages of Manchester Encoding technique?
4. What is Fiber channel? Explain various types of ports in FC.
5. What is Hub? What are the various types of Hubs? What are the advantage of network Switch over network Hubs

2.17 REFERENCES AND SUGGESTED READINGS

- Computer Network, By Andrew S Tanenbaum
- **Online Reference Sources:**
 - <https://en.wikipedia.org/>
 - <https://www.lifewire.com/>
 - <https://www.geeksforgeeks.org/>
 - <https://www.certificationkits.com/>
 - <https://www.mycloudwiki.com/>
 - <https://www.tutorialspoint.com>

UNIT 5: THE WIRELESS LAN

Space for learners

Unit Structure:

- 5.1 Introduction
- 5.2 Unit Objectives
- 5.3 Wireless LAN
 - 5.3.1 Uses of WLAN
 - 5.3.2 Advantages of WLAN
 - 5.3.3 Disadvantages of WLAN
 - 5.3.4 Working of WLAN
- 5.4 Architecture
 - 5.4.1 Station
 - 5.4.2 Service
 - 5.4.3 Types of WLAN
- 5.5 Wireless LAN protocol
 - 5.5.1 MACA
 - 5.5.2 MACAW
- 5.6 The IEEE standard
 - 5.6.1 Protocol
- 5.7 Protocol stack
 - 5.7.1 Data link layer
 - 5.7.2 Physical layer
- 5.8 Physical layer transmission technique
 - 5.8.1 Infrared
 - 5.8.2 FHSS
 - 5.8.3 DSSS
 - 5.8.4 OFDM
 - 5.8.5 HR-DSSS
- 5.9 Frame structure
- 5.10 Service
 - 5.10.1 Distribution service
 - 5.10.2 Station service
- 5.11 Summing Up
- 5.12 Answers to Check Your Progress
- 5.13 Possible Questions
- 5.14 References and Suggested Readings

5.1 INTRODUCTION

A wireless LAN is a computer network in wireless form that links two or more devices using wireless communication which forms a local area network within a limited area such as a home, school, computer laboratory, campus, or office building. In this unit, you will learn about Wireless LAN(WLAN) and how a mobile user can connect to a Local Area Network (LAN) through wireless connection. WLAN use high frequency radio wave and allow using the internet, checking e-mail and receiving instant messages while user is moving. You will get an idea about station and its categories, services, types of WLAN. You will also learn about wireless LAN protocol MACA and MACAW and the problem related to this protocol. You will be able to understand the hidden station and the exposed station problem. This unit will also discuss about IEEE standard for WLAN. This unit gives you an idea about IEEE protocol and protocol stack. A protocol is a set of rules for data communication. You will learn about the two 802.11 MAC sublayer function DCF and PCF. You will also learn about the different techniques that are used for data transmission in physical layer of WLAN. You will know about the different types of frame in 802.11. You can understand the data frame structure of 802.11 standard and its field. You will get an idea about the distribution service and the station service that are provided by 802.11 standard.

5.2 UNIT OBJECTIVES

After going through this unit, you will be able to:

- Know about the Wireless LAN, its uses, advantages and disadvantages.
- Understand station, service and types of Wireless LAN.
- Know about wireless protocol MACA and MACAW.
- Describe the IEEE 802.11 standard and its different variant.
- Understand the IEEE 802.11 sublayer protocol.
- Know how the IEEE 802.11 protocol stack is designed.
- Understand the data frame structure of 802.11.
- Describe the distribution service and the station service.

Space for learners

5.3 WIRELESS LAN

Wireless LAN stands for Wireless Local Area Network. It is also called WLAN (Local Area Wireless Network). WLAN is a local area network. It uses radio communication to provide mobility. In WLAN, a mobile user can connect to a Local Area Network (LAN) through a wireless connection that means a WLAN extends wired local area network. Users connected by wireless LANs can move around within a limited area such as home, school, campus, office building, railway platform, etc. The performance of WLAN is high as compared to other wireless networks. The IEEE 802.11 group of standards defines the technologies for wireless LANs. Most modern WLANs are based on IEEE 802.11 standards and are marketed under the Wi-Fi brand name

The workstations and the servers of a wired LAN are fixed in their native locations. For users who are highly mobile and if there is no possibility to install and lay down the cables of a wired LAN, a good solution is to install a wireless LAN. Wireless LANs transmit and receive data over the atmosphere, using radio frequency (RF) or infrared optical technology by eliminating the need for fixed wired connections. Wireless LANs provides dual advantage of connectivity and mobility. Wireless LANs have gained strong popularity in applications like health-care, retail, manufacturing, warehousing, and academic. A Wi-Fi network is a type of WLAN.

5.3.1 Uses of WLAN

Wireless LAN has many important uses. Some uses of WLANs are—

- Users would be able to surf the Internet, check e-mail, and receive Instant Messages while they are moving.
- WLANs are easy to set up networks in the areas that are affected by earthquakes or other such disasters where no suitable infrastructure may be available on the site.
- In historic buildings, WLANs are very good to set up networks where wiring may not be permitted or the building design may not be conducive to efficient wiring.

Space for learners

5.3.2 Advantages of WLAN

- **Flexibility:** A user can communicate without further restriction within radio coverage. Wireless network is suitable for any kind of geographical conditions. Installation requires to properly setup the transmitter and the receiver antenna (RF) or infrared system. This is much easier than cable installation of a wired LAN. Radio waves can penetrate walls. Senders and receivers can be placed anywhere.
- **Planning:** Wireless LAN allows communication without previous planning.
- **Design:** Wireless LAN allows the independent design. For example, small devices which can be put into a pocket. Cables not only restrict users but also designers of small notepads, PDAs, etc.
- **Robustness:** Wireless LAN can handle disasters, e.g., earthquakes, flood etc. But a LAN which requires a wired infrastructure will usually break down completely in disasters.
- **Cost:** The cost of installing and maintaining a wireless LAN is on average lower than the cost of installing and maintaining a traditional wired LAN. This is because adding additional users to a Wireless LAN will not increase the cost. Wireless LAN eliminates the direct costs of cabling.
- **Ease to Use:** Wireless LAN is easy to use and the users need very little new information to take advantage of WLAN.

5.3.3 Disadvantages of WLAN

- Wireless LAN is very prone to interference and noise.
- It has limited coverage area.
- Communication is not very secure and unauthorized access is common.
- License is required. The equipment must operate in a license free band, such as the 2.4 GHz ISM band.
- If wireless LAN uses radio transmission, many other electrical devices can interfere with them.

Space for learners

- Several govt. and non-govt. institutions regulate the operation in world-wide and restrict frequencies to minimize interference.

Space for learners

5.3.4 Working of WLAN

Wireless LANs use radio or infrared technology to communicate information from one point to another without relying on any physical connection. The data being transmitted is superimposed on the radio carrier so that it can be accurately extracted at the receiving end. It is the modulation of the carrier by which the information being transmitted. Multiple radio carriers can exist in the same space at the same time. This carrier does not interfere with each other if the radio waves are transmitted on different radio frequencies. To extract data, a radio receiver tunes in one radio frequency while rejecting all other frequencies. In a typical wireless LAN configuration, an access point connects to the wired network from a fixed location using standard cabling. The access point receives buffers and retransmits data between the wireless LAN and the wired network infrastructure. A single access point can support a small group of users and can function within a range of less than one hundred to several hundred feet.

Wireless LAN adapters provide an interface between the client network operating system (NOS) and the airwaves via an antenna. The nature of the wireless connection is transparent to the NOS.

5.4 ARCHITECTURE

In this section, we will discuss the components used in WLAN. We will learn about the purpose of these components.

5.4.1 Station

A Station refers to all components that can connect into a wireless medium in a network. All stations are equipped with wireless network interface controllers.

Wireless stations are of two categories

- Wireless access point

- Client.

Access points are normally wireless routers. These access points are base stations for the wireless network. They transmit and receive radio frequencies for wireless enabled devices to communicate. Wireless clients can be mobile devices such as laptops, personal digital assistants, IP phones and other smartphones, or non-portable devices such as desktop computers, printers, and workstations that are equipped with a wireless network interface.

Space for learners

5.4.2 Service

There are two types of services in WLAN

- Basic services set
- Extended Service Set

5.4.2.1 Basic Services Set

The basic services set (BSS) contain stationary or mobile wireless stations and a central base station called access point (AP). All station in basic service set can communicate with each other at Physical Layer. A Basic Service Set has an identification number known as BSSID. BSSID is the MAC address of the access point servicing the BSS.

There are two types of BSS---

- Independent BSS
- Infrastructure BSS

An independent BSS (IBSS) is an ad hoc network that contains no access points. They cannot send data to any other basic service set.

In Infrastructure BSS, the BSS contains an access point.

5.4.2.2 Extend Service Set

An extended service set (ESS) is created by joining two or more basic service sets (BSS) having access points (APs). Access points in an ESS are connected by a distribution system. Each ESS can be

identified by an ID called the SSID which is a 32-byte (maximum) character string.

ESS has two types of station---

- **Mobile station:** These are the normal stations inside a BSS.
- **Stationary station:** These are AP stations that are part of a wired LAN.

Two stations in two different BSS can communicate using their AP.

5.4.3 Types of WLAN

WLAN has two basic modes of operation

- Infrastructure
- Ad hoc mode.

5.4.3.1 Infrastructure Mode

In this mode, mobile units communicate through an access point that serves as a bridge to other networks (such as Internet or LAN). Wi-Fi networks are employed in infrastructure mode. A base station can work as a wireless access point hub through which nodes can communicate. The hub usually has a wired or fiber network connection and may have permanent wireless connections to other nodes. Wireless access points are usually fixed and provide service to their client nodes within range.

5.4.3.2 Ad-Hoc Mode

In this mode, mobile units transmit directly peer-to-peer.

There is no base station and no one gives permission to talk. This is accomplished using the Independent Basic Service Set (IBSS).

A peer-to-peer network allows wireless devices to directly communicate with each other. Wireless devices within range of each other can discover and communicate directly without involving central access points. This method is typically used by two computers so that they can connect to each other to form a network. This can basically occur in devices within a closed range.

Space for learners

CHECK YOUR PROGRESS

1. A WLAN uses _____ for communication.
2. WLAN can be configured in _____ ways.
3. A Basic Service Set has an identification number known as _____.
4. Access points are normally wireless _____.
5. State true or false
 - a. Wi-Fi allows only laptops in its range.
 - b. In Wireless ad-hoc network, access point is not required.
 - c. The cost of installing and maintaining a wireless LAN is higher than the cost of installing and maintaining a traditional wired LAN

Space for learners

5.5 WIRELESS LAN PROTOCOL

Wireless LAN is an extension of LAN. So, it has some different properties than the conventional LAN. A special MAC sublayer is required for wireless LAN. In a simple approach of Wireless LAN, CSMA protocol can be used. But Wireless stations have transmission ranges and all stations are not within radio range of each other. So, simple CSMA will lead to Hidden station problem and Exposed station problem.

Let us consider the situation given in a hidden station problem as shown in figure 5.1.

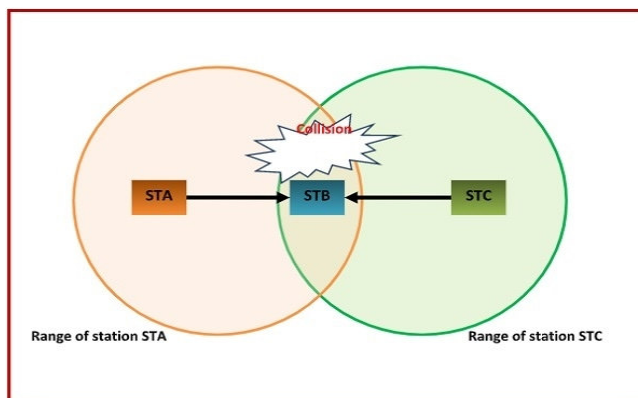

Figure 5.1: The hidden station problem

There are three stations labelled STA, STB, and STC in the above figure. The two stations STA and STC are not in the radio range of each other. The station STA and STC both cover station STB in their radio range

STA starts transmitting to station STB. Since station STC is out of radio range of STA, it concludes that the channel is free and starts transmitting to STB. The frames received by STC are garbled and collision occurs. The problem is a transmission problem that arises when two or more stations that are out of range of each other transmit simultaneously to a common recipient. This situation is known as the hidden station problem.

Let us consider another situation as shown in the figure 5.2.

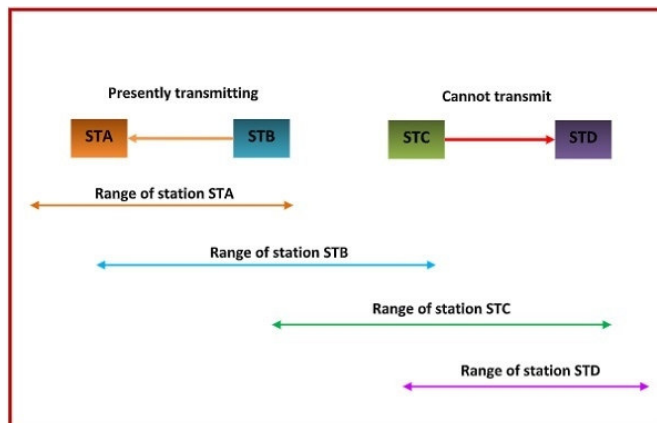

Figure5.2: The exposed station problem

The two receivers STA and STD are out of radio range of each other, but the station STB and STC are in radio range of each other in the above figure. When STB is transmitting to STA, STC falsely concludes that the transmission will cause collision and so stops its transmission to STD. But the collision would not have occurred because the transmission from STC to STD is out of range of STB. The problem is that a transmitting station is prevented from transmitting frames because of interference with another transmitting station. This problem is known as exposed station problem.

STOP TO CONSIDER

CSMA is a carrier sense multiple access based on media access protocol to sense the traffic on a channel before transmitting the data. The main idea is that if the channel is idle, the station can send data to the channel otherwise it must wait until the channel becomes idle. Hence, it reduces the chances of a collision on a transmission medium.

5.5.1 MACA

MACA (Multiple Access with Collision Avoidance) is a protocol designed for Wireless LAN. MACA was proposed to overcome the shortcomings of CSMA protocols when used for wireless networks. The hidden station problem and exposed station problem in CSMA can be solved using this protocol.

The main idea behind MACA is that the stations have to be synchronized with frame sizes and data speed. Before starting transmission of data frames between two stations, the sender transmits a frame called RTS (Request to Send) and the receiver responds with a frame called CTS (Clear to Send).

MACA protocol is presented in figure 5.3 where a station A has data frame to send to a station B. A will send RTS frame to the B. Then B will send CTS frame to A.

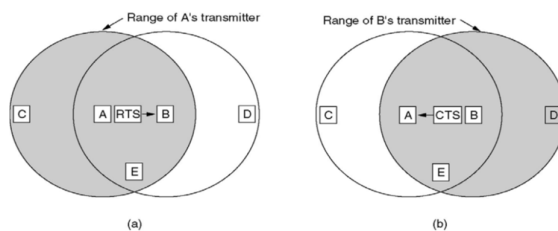

Figure 5.3: The MACA protocol. (a). A send an RTS to B. (b). B responds to A with a CTS

When A gets CTS frame from B, it starts to send data to station B.

After getting an RTS from a nearby transmitting station A, a station keeps silent until the CTS transmitted back to station A without conflict. Stations which get the CTS are near to the receiving station and keep silent during the data transmission.

Let us see how MACA solves the hidden and exposed station problem.

Station C gets RTS from station A. But the CTS from station B does not reach station C because C is not within the range of B. So, C is free to transmit while the data frame is being sent as it does not interfere with the CTS. In other hand, Station D does not get RTS from station A but it gets CTS frame from B. This is because D is in the range of B but not in range of A. So, it realizes that B is busy and defers its transmission to avoid collision. Thus, MACA resolves the hidden station problem and the exposed station problem with the help of RTS and CTS frame.

But collision can still occur in spite of all these provisions. In figure5.3, both station B and C can send RTS to station A simultaneously. These will cause collision and RTS will be lost.

5.5.2 MACAW

MACAW is an improved version of MACA protocol which is designed for Wireless LAN. It makes use of RTS and CTS from MACA protocol and employ RTS-CTS-DS-DATA-ACK frame sequence to transmit data.

MACAW initiates an ACK frame after each successful transmission of data frame. It also adds carrier sensing. The backoff algorithm is chosen to run individually for each data stream not per station. This change leads to a fair protocol. In this protocol, the backoff algorithm responds less violently to temporary problem by using a mechanism to improve system performance.

A successful data transfer (A to B) consists of the following sequence of frames:

1. A sends RTS to B
2. B sends CTS A
3. A sends “Data Sending” frame (DS) to B
4. A sends DATA fragment frame from to B
5. B acknowledges A bysending Acknowledgement frame (ACK).

Space for learners

CHECK YOUR PROGRESS

6. _____ sublayer is needed for WLAN.
7. _____ lead to hidden station and exposed station problem.
8. RTS stands for _____.
9. The improved version of MACA designed for WLAN is _____.
10. State true or false
 - a. MACAW uses an ACK frame.
 - b. Collision cannot occur in MACA.
 - c. The backoff algorithm run individually for each data stream in MACW.

Space for learners

5.6 THE IEEE STANDARD

IEEE formed a working group to develop a Medium Access Control (MAC) and Physical Layer standard for wireless connectivity for stationary, portable, and mobile computers within a local area. This working group is IEEE 802.11. IEEE 802.11 is the standard for WLAN. There are some standards of IEEE 802.11. The important among them are —

1. 802.11

IEEE 802.11 was the original version. It gives 1 Mbps or 2 Mbps data rate in the 2.4 GHz band but it is outdated now. Either frequency-hopping spread spectrum (FHSS) or direct-sequence spread spectrum (DSSS) is used by this standard.

2. 802.11a

This standard achieves data transfer speeds as high as 54Mbps within a 5GHz frequency range. It employs Orthogonal Frequency Division Multiplexing (OFDM). Due to its high frequency, it has difficulty in penetrating walls and other obstructions. Signal coverage is comparatively less than other standards but expensive to implement.

3. 802.11b

It operates within the 2.4GHz range and supports 11Mbps bandwidth speed. It uses the multiple access method known as Carrier Sense Multiple Access with Collision Avoidance (CSMA/CA). It is less vulnerable to obstructive

interferences such as walls. It has low implementation cost with a good data transmission signal. It facilitates path sharing through its supported bandwidth.

4. **802.11g**

This standard combines the features of 802.11a and 802.11b protocols. 802.11g supports both the 5GHz (802.11a standard) and 2.4GHz (802.11b standard) frequencies, which allows it to operate at wider ranges. It uses OFDM technique. 802.11g is backward compatible with 802.11b devices that means their access points and network adaptors can work interchangeably. It is more expensive for implementation but provides high speeds, varying signal range, and flexibility to obstruction.

5. **802.11n**

This standard is an upgraded version of 802.11g. 802.11n operates on variable data rate ranging from 54 Mbps to 600 Mbps which produces better signal coverage with wider radio frequency. It is an improvement over previous standards 802.11 by incorporating multiple-input multiple-output (MIMO). MIMO implements multiple antennas at both the transmitter end and receiver ends.

5.6.1 Protocol

The IEEE 802.11 protocol is specified in terms of coordination function. This function determines when a station is allowed to transmit and when it may be able to receive data over the wireless medium. The IEEE 802.11 MAC sublayer protocol is the standard for wireless LAN. IEEE 802.11 MAC sublayer uses two coordination functions for collision avoidance before transmission –

1. Distributed Coordination Function
2. Point Coordination Function

Space for learners

5.6.1.1 Distributed Coordination Function

The Distributed coordination function (DCF) is an improved version of Carrier Sense Multiple Access with Collision Avoidance (CSMA/CA). The DCF is used in BSS having no access point. It provides support for asynchronous data transfer. In this function, CSMA/CA uses both physical channel sensing and virtual channel sensing.

In physical channel sensing, a station senses the channel when it has to send data. If the channel is idle, the station sends the entire frame. During the transmission, it does not sense the channel so collision may occur. If the channel is busy, the station waits for it to be idle and then send. A colliding station waits for a random time using the binary exponential backoff algorithm after a collision occurs and try again.

The virtual channel sensing in CSMA/CA is based on MACAW. This works as presented in the figure 5.4.

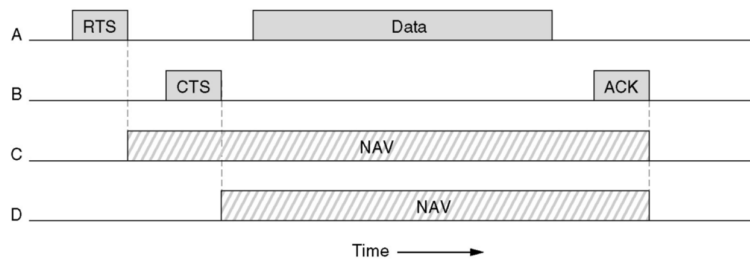

Figure 5.4: The virtual channel sensing using CSMA/CA

A sends an RTS frame to B when it has data to send. After receiving the request, B responds with CTS if it decides to give permission. A sends its data and starts an ACK timer when it gets the CTS from B. B sends an ACK frame after receiving the correct data. If the ACK reach A after the ACK timer of A expires, the whole protocol is run again.

C receives the RTS as it is in the range of A. Then C generates a virtual channel busy NAV (Network Allocation Vector) for itself. D is in the range of B so it gets the CTS. After getting the CTS, it creates a shorter NAV for itself. NAV is adjusted from the duration field in the data frame or in RTS and CTS frames. The stations

which assert NAV are not allowed to transmit data to avoid collisions

Space for learners

STOP TO CONSIDER

NAV is a virtual carrier sensing mechanism with collision avoidance (CSMA/CA). This signal is not transmitted. It is only an internal reminder to remain quiet for certain amount of time. The NAV can be considered as a counter which counts down to zero. When the counter is zero, the virtual carrier-sensing indicates that the channel is idle. When it is nonzero, the channel is busy.

For noisy channel, long packets have less probability of being successfully transmitted. It will result high error rates. To solve this problem, 802.11 allow fragmentation with stop-and-wait protocol on the fragments as depicted in the figure 5.5.

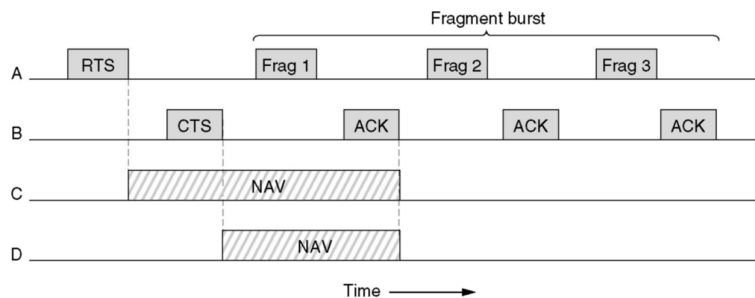

Figure 5.5: Data fragmentation

Multiple fragments can be transmitted in a row after getting the channel. It will increase the throughput because the bad fragment is only transmitted rather than the entire frame.

5.6.1.2 Point Coordination Function

It is an optional function used by 802.11 MAC Sublayer. The point coordination function (PCF) is a polling-based access scheme with no contention. The base station performs polling for stations that wants to transmit data. Base station sends beacon frame periodically. The various stations are polled one after the other. In PCF, the base station takes control of the transmission. So, no collision occurs.

STOP TO CONSIDER

Beacon frame contains network information needed by a station before it can transmit a frame. They are used for announcing the presence of devices in a WLAN as well as synchronization of the devices and services. It is a management frame.

5.6.1.3 Co-existence of PCF and DCF

In 802.11, point and distribution control function can co-exist using interframe Spacing (IFS). The Inter Frame Spaces define the minimum time that a station needs to wait after it senses the channel free. Shorter IFS denotes a higher priority to access the medium. Four different intervals are defined for their specific purpose. Figure 5.6 presents Interframe spacing.

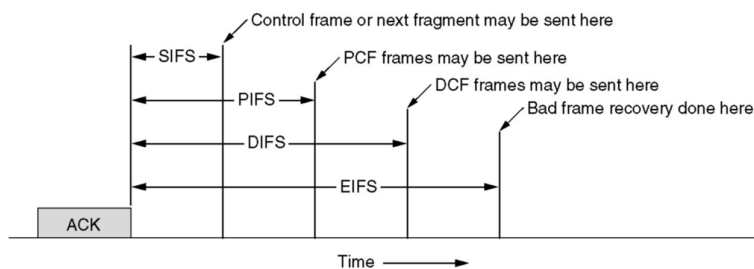

Fig:5.6 Interframe spacing in 802.11

1. SIFS

SIFS (Short Interframe Spacing) is the shortest IFS used for the high priority frames like acknowledgement frames, CTS frames, poll response etc. The transmission of fragment should begin only after the channel is sensed to be idle for a minimum time period of at least SIFS.

2. PIFS

When no station responds to SIFS and a time PIFS (PCF Interframe Spacing) times out, then the base station can issue beacon or poll which allow a station to send data frame.

3. DIFS

When there is no PIFS and a time DIFS (DCF interframe Spacing) expires, any station can attempt to acquire the

channel to transmit data frame. It is equal to SIFS plus two time slots and is the longest inter frame gap.

4. EIFS

Extended IFS is the lowest priority interval used to report bad or unknown frame.

CHECK YOUR PROGRESS

11. _____ is the standard for WLAN.
12. The original standard of WLAN uses _____ and _____ transmission technique.
13. The throughput of IEEE standard 802.11b is less than or equal to _____.
14. CSMA/CA uses both _____ and _____ in DCF.
15. State true or false
 - a. 802.11 allow fragmentation of data using sliding window protocol.
 - b. DCF performs polling for station.
 - c. When PIFS time out, base station can send beacon frame.

Space for learners

5.7 PROTOCOL STACK

A protocol stack refers to a group of protocols that are running concurrently. The interconnectivity rules for a layered network model are determined by the protocol stack. To become a stack, the protocols must be interoperable for being able to connect both vertically between the layers of the network and horizontally between the end-points of each transmission segment. A certain similarity of structure is used by the all the 802 variants. A partial view of 802.11 protocol stack is given in the figure 5.7.

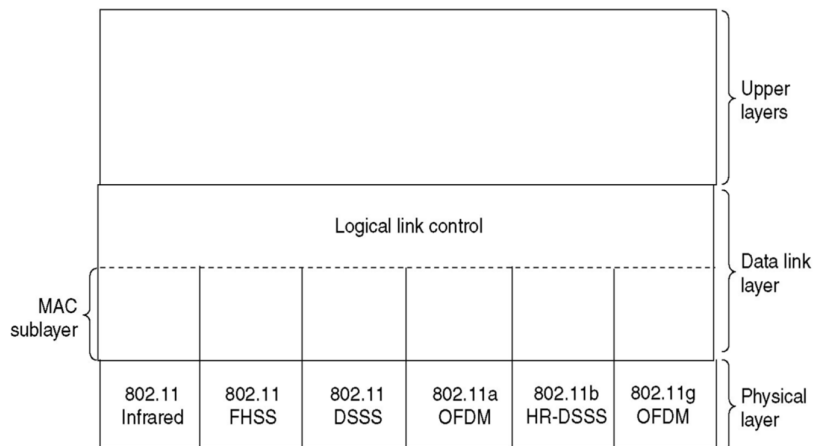

Figure 5.7: Part of 802.11 protocol stack

5.7.1 Data Link Layer

The data link layer is split into two sub layers:

- Logical Link Control
- MAC sublayer

The dissimilarity between the different standard of 802 are hidden by the logical Link Control (LLC). Thus, LLC makes 802 standards identical for the network layer. MAC sublayer determines who acquires the channel to transmit next.

5.7.2 Physical Layer

The physical layer resembles to the OSI layer. It is responsible for converting data stream into signals. The bits of 802.11 networks can be converted to radio waves or infrared waves.

5.8 PHYSICAL LAYER TRANSMISSION TECHNIQUE

There are five transmission techniques allowed in the physical layer. The techniques are Infrared, FHSS, DSSS, OFDM and HR-DSSS. We will discuss it briefly in next section. It is possible to send data from one station to another using the transmission technique.

Space for learners

5.8.1 Infrared

It uses diffused infrared light in the range of 800 to 950 nm. It allows two different speeds that are 1Mbps and 2Mbps. For converting digital signal to analog, pulse position modulation (PPM) is used. Infrared method uses the same technology as television remote controls.

5.8.2 FHSS

Frequency Hopping spread spectrum (FHSS) spreads the signal over a wider frequency to minimize the interference from other devices. This method uses 2.4 GHz ISM band. This band is divided into 79 sub-bands of 1MHz with some guard bands. A pseudo random number generator selects the hopping sequence. The allowed data rates are 1 or 2 Mbps. This method uses frequency shift keying for modulation.

5.8.3 DSSS

Direct Sequence Spread Spectrum (DSSS) spreads signal over entire spectrum using pseudo-random sequence as CDMA. Each bit is transmitted in an 11-bit chipping Barker sequence. It uses phase shift keying (PSK) technique at 1 M baud. This technique operates on 1 or 2 Mbps.

5.8.4 OFDM

Orthogonal Frequency Division Multiplexing (OFDM) uses for signal generation. This method is capable of delivering data upto 18 or 54 Mbps. It uses 5 GHz ISM band. The data rate is 18 Mbps if phase shift keying (PSK) is used for modulation. If quadrature amplitude modulation (QAM) is used, the data rate can be 54 Mbps. It uses 5 GHz ISM band. This band is divided into 52 sub-bands. 48 sub bands are used for data and 4 sub bands are used for control information.

Space for learners

5.8.5 HR-DSSS

High-Rate Direct Sequence Spread Spectrum (HR-DSSS) uses 11 million chips/sec. It achieves 11 Mbps in 2.4 GHz band. It supports four data rates: 1,2,5.5 and 11 Mbps. 1 Mbps and 2 Mbps data rates uses phase shift modulation.

5.9 FRAME STRUCTURE

The 802.11 framing is complex because the wireless medium requires several management features and frame types that are not required in wired networks. It defines three types of frames that are data, control and management.

Data frame are used for carrying data and control information. Control frame are used for accessing the channel and acknowledging frames. The control frames are RTS and CTS. Management frame are used for initial communication between stations and access points.

The 802.11 frames consist of 9 fields. Figure 5.8 shows the basic structure of an IEEE 802.11 data frame along with the content of the frame control field.

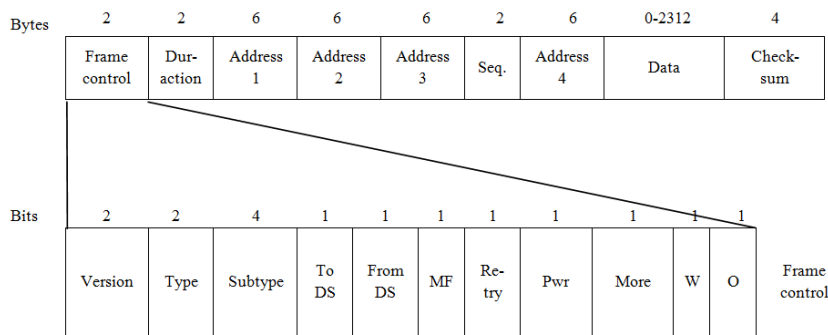

Figure 5.8: The data frame structure of 802.11

Frame Control is a 2byte starting field composed of 11 subfields. It defines type of frame and some control information. The 11 subfields are –

1. **Version** – It is a two-bit long field which indicates the current protocol version which is fixed to be 0 for now. It has been included to allow future versions of IEEE 802.11 to operate simultaneously.
2. **Type** – It is a two-bit subfield that specifies whether the frame is a data frame, control frame or a management frame.

Space for learners

3. Subtype –It is a four-bit long field which indicates sub-type of the frame. It states whether the field is a Request to Send (RTS) or a Clear to Send (CTS) control frame. For a regular data frame, the value is set to 0000.

4. To DS –It is a single bit subfield indicating whether the frame is going to a distributed system. This bit is set to 1 if the frame was sent to the DS.

5. From DS – It is a single bit subfield and set to 1 if the frame is coming from the distributed system.

6. MF – It is a single bit subfield which is set to 1 to indicate that the fragments are followed by more fragment.

7. Retry –It is single bit long field and set to 1 if the current frame is a retransmission of an earlier frame.

8. Pwr –It is 1-bit long field which indicates the mode of a station after successful transmission of a frame. It is set to 1 to indicate that the station goes into power-save mode. If the field is set to 0, the station stays active.

9. More Data – It is a single bit subfield to indicate that sender has further data frames for the receiver.

10.W –It is 1-bit long field which indicates that the frame body has been encrypted using WEP algorithm.

11. Order –It is 1-bit long field. It is set to 1 to inform the receiver that the frames should be in an ordered sequence.

Duration is a 2-byte field that specifies the time period for which the frame and its acknowledgement occupy the channel.

Address fields are 6-byte address fields which contain standard IEEE 802 MAC addresses (48 bit each). Two addresses contain the addresses of source and destination. And the other two are source and destination base station respectively.

Seq is a 2 bytes field that stores the frame numbers. Among the 16 bits, the 4 bits identify the fragment and the rest 12 bits identify the frame.

Data is a variable length field which contain information specific to individual frames which is transferred transparently from a sender to the receiver. The maximum size of data field is 2312 bytes.

Checksum is 4 bytes long and contains a 32-bits CRC error detection sequence to ensure error free frame.

Space for learners

5.10 SERVICES

The 802.11 standard services provide the functions that require for sending data between two entities on the network. These services fall into two categories

- Distribution Service
- Station Service

5.10.1 Distribution Service

Access points provide distribution services that deal with station mobility. The distribution service is used to manage cell membership and to interact with stations outside the cell. Distribution system services provide functionality across a distribution system. The function are as follows.

5.10.1.1 Association

Each station uses the association service to connect an access point before it can send information through a distribution system. The association maps a station to the distribution system via an access point. A station moves within the radio range of base station and uses this service. It declares its identity and capabilities after arrival. Each station can associate with only a single access point, but each access point can associate with multiple stations. The base station may accept or reject the mobile station.

5.10.1.2 Disassociation

A station or access point can invoke the disassociation service to break an existing association. Stations should use disassociation before leaving the network. An access point may disassociate all its stations before removed for maintenance.

5.10.1.3 Distribution

A station uses this service for sending frames to the base station. The distribution service provides information about how to route

frames sent to base station. A frame can be sent over air directly when the destination is local for base station. If not, the frame has to be sent over wired network.

5.10.1.4 Reassociation

The reassociation service enables a station to change its current state of association. A station can change its association from one access point to another by this service. The mobile station always initiates the reassociation service. No data will be lost due to handover if the service is properly used.

5.10.1.5 Integration

The integration service enables the delivery of a frame through a non-802.11 network. The integration function performs all required translations from the 802.11 format to the required format of destination network.

5.10.2 Station Service

The 802.11 standard defines services for providing functions among stations. All access points implement station services. This service is used after a station connects to base station. To provide necessary functionality, these stations need to implement adequate levels of security.

5.10.2.1 Authentication

Every 802.11 station must use the authentication service before establishing a connection with another station with which it will communicate. Stations performing authentication send a unicast management authentication frame to the corresponding station. This type of authentication assumes that each station has received a secret shared key through a secure channel independent from the 802.11 network. Stations authenticate through shared knowledge of the secret key. 802.11 requires mutually acceptable, successful authentication before association.

Space for learners

5.10.2.2 Deauthentication

A station invokes the deauthentication service when it wants to disassociate from another station. Deauthentication is a notification and cannot be refused.

5.10.2.3 Privacy

All stations and other devices can hear data traffic taking place within range on the network. It affects the security level of a wireless link. So, data sent over the Wireless network must be encrypted. The encryption and decryption are managed by this service.

5.10.2.4 Data Delivery

This service determines how data are transmitted and received. Detecting and correcting errors must be handled by the higher layers.

Space for learners

CHECK YOUR PROGRESS

16. The data link layer in 802.11 protocol stack is divided into _____ and _____.
17. DSSS uses _____ modulation technique.
18. _____ frames are used for accessing the channel and to acknowledge frames.
19. Source and destination address are stored in _____ fields of data frames.
20. **State True or False:**
 - a. The maximum size of data field in 802.11 data frame structure is 2312 bytes.
 - b. In association, an access point can associate with a single station.
 - c. Privacy service in 802.11 manages encryption and decryption.

5.11 SUMMING UP

- A Wireless LAN connects computers without using network cables. Computer uses radio frequency to send data between each other.
- You can communicate directly with other wireless computer or connect to an existing network through an access point.
- User can use Internet, check mail while they are moving. WLAN are flexible with independent design. It eliminates the direct cost of cabling. But it is prone to interference and noise.
- Wireless station has two types of station which are Wireless access point and clients.
- WLAN has two types of service that are Basic service set (BSS) and Extended service set (ESS).
- WLAN has two modes of operation that are infrastructure and Ad hoc mode. In infrastructure mode, communication uses an access point and in Ad hoc mode, there is no access point.
- CSMA protocol leads to hidden station and exposed station problem. MACA is used to solve these problems using RTS and CTS frame but it may also lead to collision.
- MACAW is an improved version of MACA designed for WLAN. It uses ACK frame after each data frame.
- The IEEE 802.11 is a standard for WLAN. 802.11a, 802.11b, 802.11g and 802.11n are some important standards of IEEE 802.11.
- The IEEE 802.11 sublayer protocol uses two functions DCF and PCF. DCF uses physical channel sensing and virtual channel sensing with CSMA/CA. 802.11 allows data fragmentation for noisy channel which increase throughput. PCF performs polling for station and use beacon frame periodically.
- DCF and PCF can co-exist using interframe spacing.
- In 802.11 protocol stack, the data link layer is subdivided into two sublayer that are logical link control and MAC

Space for learners

sublayer. The physical layer uses five different data transmission technique Infrared, FHSS, DSSS, OFDM and HR-DSSS.

- 802.11 supports three types of frames that are data, control and management frames.
- Access point provides distribution service for station mobility and station service relate to activity within in a single station.

5.12 ANSWERS TO CHECK YOUR PROGRESS

1. Radio frequency
2. Two
3. BSSID
4. Routers
5. a. F b. T c. F
6. 802.11 MAC
7. CSMA
8. Request to Send
9. MACW
10. a. T b. F c. T
11. IEEE 802.11
12. FHSS and DSSS
13. 11 Mbps
14. Physical channel sensing and virtual channel sensing
15. a. F b. F c. T
16. Logical link control and MAC sublayer
17. Phase shift keying
18. Control
19. Address
20. a. T b. F c. T

5.13 POSSIBLE QUESTIONS

Short answer type questions:

1. Why do you need WLAN?
2. What are the uses of WLAN?

Space for learners

3. What do you mean by station in WLAN?
4. What is the Extended Service set?
5. What do you mean by Ad hoc mode in WLAN?
6. What is the hidden station problem?
7. What do you mean by exposed station problem?
8. What is the main idea behind MACA?
9. What is IEEE 802.11?
10. What is the principle behind point Coordination Function?
11. What is the principle behind FHSS?
12. What is infrared transmission?
13. What are the main types of frame in 802.11 frame structure?
14. Explain the importance of version field in 802.11 frame structure.
15. What are the main types of service present in 802.11 standard?
16. Define the authentication service in IEEE802.11.

Long answer type questions:

1. What is WLAN? Discuss its advantages and disadvantages.
2. What are the types of WLAN? Explain.
3. How can MACA protocol be used to solve hidden and exposed station problem? Explain.
4. Explain the DCF mechanism used in IEEE 802.11 WLAN.
5. Explain the advantages of MACAW over MACA.
6. Explain some important standard of IEEE 802.11.
7. What do you understand by inter frame spacing. Explain briefly its type.
8. Explain the 802.11 protocol stack.
9. Describe the different transmission technique used in the physical layer of 802.11.
10. Explain briefly the different field present in 802.11 data frame structure.

Space for learners

11. What are the 802.11 standard distribution services? Explain.

Space for learners

5.14 FURTHER READINGS

1. Tanenbaum, Andrew S. Computer Network. Pearson.
2. <https://ecomputernotes.com/computernetworkingnotes/communication-networks/wireless-lan>.
3. <https://www.tutorialspoint.com/what-are-wireless-lans>.

BLOCK III:
THE NETWORK, TRANSPORT AND
APPLICATION LAYERS

UNIT 1: THE NETWORK LAYER: DESIGN ISSUES

Space for learners

Unit Structure:

- 1.1 Introduction
- 1.2 Unit Objectives
- 1.3 Introduction to network layer
- 1.4 Store and forward packet switching
- 1.5 Transport Layer and its Services
 - 1.5.1 Services
 - 1.5.2 Connection
 - 1.5.3 TPDU
- 1.6 Connection-less and Connection oriented services
- 1.7 Virtual Circuit Vs Datagram Subnets
 - 1.7.1 Virtual Circuits
 - 1.7.2 Datagram Subnets
 - 1.7.3 Comparison
- 1.8 Summing Up
- 1.9 References and Suggested Readings
- 1.10 Possible Questions
- 1.11 Answers to Check Your Progress

1.1 INTRODUCTION

The Network layer manages device addressing, tracks the location of devices on the network. It determines the best path to move data from source to the destination based on the network conditions, the priority of service, and other factors. The protocols which are used for executing all these services are known as Network layer protocols. Transport layer is a Layer 4 of the OSI stack. The main responsibility of the transport layer is to transfer the data completely. It receives the data from the upper layer and converts them into smaller units known as segments. This layer can be termed as end-to-end layer as it provides a point-to-point connection between source and destination to deliver the data reliably. Two main protocols used in this layer are TCP (Transmission Control Protocol) and UDP (User Datagram Protocol). Simply, Network layer and Transport layer are responsible for moving messages from

end to end in a network. The transport layer performs some main functions like linking the application layer to the network, segmentation (breaking long messages into smaller packets for transmission), and session management (establishing an end-to-end connection between the sender and receiver). The network layer performs some crucial functions like routing and addressing (finding the address of that next computer). In this unit, we will study some of the important topics related to both the Network and Transport Layers.

Space for learners

1.2 UNIT OBJECTIVES

This unit significantly covers functionalities and services of Network and Transport Layer. After going through this unit, you will be able to –

- Know the functionalities of Network Layer.
- Know the functionalities of Transport layer
- Learn various services of Transport layer.
- Learn various services of Network Layer.
- Acquire the concept of store and forward packet switching.
- Know about connection establishment and connection termination.
- Get to know thoroughly about virtual circuit and datagram subnets.
- Understand about connection oriented and connectionless services.

1.3 INTRODUCTION TO NETWORK LAYER

In the 7-layers Open Systems Interconnection (OSI) communications model, Network Layer is the layer 3 (Third layer) of the OSI model from the physical point of view. The main function of network layer is to forward the packets from sender to destination(receiver) along with some other works such as routing packets, logical addressing, etc.; that is why this layer is considered as the backbone of OSI model. Network layer responds to requests from the layer above it (transport layer) and accepts a packet, encapsulates it and then

issues requests to the layer below it (data link layer) so that it can be sent to the receiver since data link layer already contains information about the source and destination hosts. Some of the functionalities and services of network layer are –

- **Routing:** It determines the route from the source to the destination and also manages the traffic problems such as switching, routing and controls the congestion of data packets.
- **Addressing:** The data link layer implements the physical addressing and network layer implements the logical addressing. Logical addressing is used to distinguish between source and destination system. The source and destination addresses are added to the data packets inside the network layer header.
- **Internetworking:** It is the exercise of interconnecting multiple computer networks, such that any pair of hosts in the connected networks can exchange messages irrespective of their hardware-level networking technology.
- **Fragmentation:** If the packets are too large for delivery, they are fragmented i.e., broken down into smaller packets.
- **Packetizing:** The process of encapsulating the data received from upper layers of the network (also called as payload) in a network layer packet at the source and un-wrapping the payload from the network layer packet at the destination is known as packetizing.
- **Network Layer protocols:** Numerous numbers of protocols are employed for controlling and managing tasks of switching, routing, error control, flow control and congestion of data.
- **Guaranteed Delivery:** The Network Layer provides the service which guarantees the delivery of packets in the destination. With guaranteed delivery, network layer also ensures that the packet arrives at the destination in the order in which they are sent.

1.4 STORE AND FORWARD PACKET SWITCHING

The packet switching is a switching technique in which the data is transferred in one go, but it is divided into smaller pieces called packets, and they are sent individually. Generally, the network layer

Space for learners

operates in an environment that uses store and forward packet switching. In store and forward packet switching which is shown in Figure 1, the data packets are stored in each intermediate node before they are forwarded to the next node. This technique is very beneficial because packets may get discarded at any hop due to some reason. More than one path is possible between a pair of sources and destinations. The intermediate node also checks whether the packet is error-free before transmitting, thus ensuring integrity of the data packets. Data packets belonging to the same file may or may not travel through the same path. If there is congestion at any path, packets are allowed to choose different paths over an existing network.

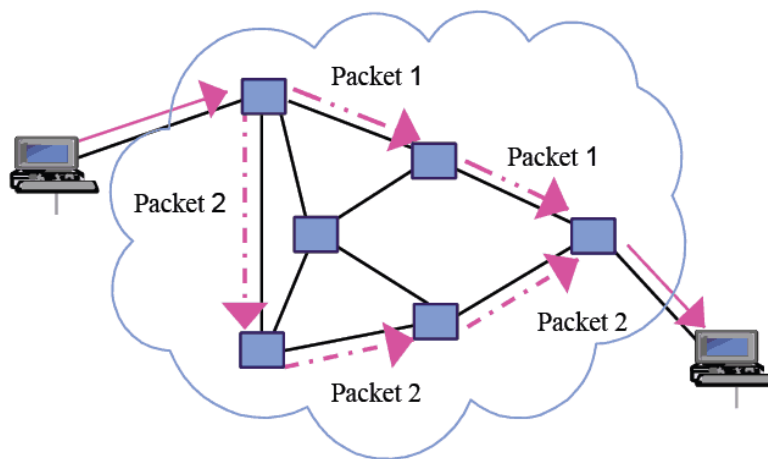

Figure 1: store and forward packet switching (Source: Network Encyclopedia)

1.5 TRANSPORT LAYER AND ITS SERVICES

Transport layer is the 4th layer in the OSI communications model. Transport layer's main goal is to make end to end communication over a given network, and it also delivers different communication services directly to application processes working on various dissimilar hosts. The services provided are similar to those of the data link layer. The data link layer, however, is designed to provide its services within a single network, while the transport layer provides these services across an internetwork made of many networks. The services provided by transport layer protocols can be

divided into five broad categories: end-to-end delivery, addressing, reliable delivery, flow control, and multiplexing. Figure 2 presents various transport layer services.

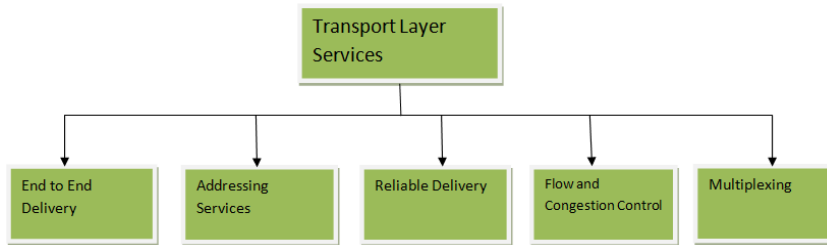

Figure 2: Transport layer services

1.5.1 Services

End to End Delivery:

The transport layer is responsible for creating the end-to-end connection between hosts for which it mainly uses TCP and UDP. TCP is a secure, connection-oriented protocol which uses a handshake mechanism to establish a robust connection between two end hosts. TCP ensures reliable delivery of messages and is used in various applications. UDP, on the other hand, is a stateless and unreliable protocol which ensures best-effort delivery. It also ensures process to process delivery from source to destination by invoking 16-bit port number, which can identify any client-server uniquely.

Addressing Services:

While we are communicating with different applications, sometimes it is important to ensure accurate delivery from the end-to-end application. That's why, we need another level of addressing just like data link layer and network layer addressing. In the transport layer, the protocol needs to know which upper-layer protocols are communicating.

Reliable Delivery:

Transport layer generally ensures reliable delivery using its efficient mechanisms like error control, sequence control, loss control, duplication control, etc.

Flow and Congestion Control:

Space for learners

In Flow and congestion control, mainly Traffic is controlled. In flow control, Traffic represents data flow from sender to receiver and in Congestion Control, Traffic represents data flow entering into the network. Flow control is used to prevent the sender from overloading the receiver side. If it is overloaded, then the receiver discards the packets and asks for the retransmission of packets. This increases network congestion and thus, reducing the system performance. Congestion is a situation in which too many sources over a network attempt to send data and the router buffers start overflowing due to which loss of packets occur. So, like data link layer, transport layer is also responsible for flow control and congestion control.

Multiplexing:

Multiplexing improves the efficiency of transmission. Packet streams from various applications can be sent simultaneously over a network using multiplexing. So, Multiplexing allows simultaneous use of different applications which run on a host. Those stream packets from different processes can be easily differentiated by their port numbers and then the layer will pass them to the network layer after adding proper headers. Similarly, De-multiplexing is required at the receiver side to obtain the data coming from various processes.

CHECK YOUR PROGRESS - I

- 1:** What is Packet Switching?
- 2:** Write a brief note about store and forward packet switching?
- 3:** What do you mean by flow control and congestion control?
- 4:** Explain the services provided by Transport Layer.
- 5:** Write down the functionalities of the Network Layer.

1.5.2 Connection

End to end delivery can be accomplished in two ways: connection-oriented and connectionless. A connection-oriented protocol establishes a virtual circuit or pathway through the internal between sender and receiver. All of the packets belonging to a message are then sent over this same path. Using a single pathway for the entire message facilitates the acknowledgement process and

Space for learners

retransmission of damaged and lost frames. Connection-oriented services is generally considered reliable. Connection-oriented transmission has three stages:

1. Connection establishment.
2. Data transfer
3. Connection termination.

Connection Establishment:

Before transferring data, device must determine the status of the receiver and a pathway must be found through the network by which information can be sent. This step is called connection establishment, which requires three-way handshaking mechanism:

- The computer or device requesting the connection sends a connection request packet to the intended receiver.
- The responding computer or device returns a confirmation packet to the requesting computer.
- The requesting computer or device returns a packet acknowledging the confirmation.

Connection Termination:

Once data transmission has been finished, then the connection must be terminated. Here, three- way handshaking rule is employed as -

- Requesting computer or device sends a disconnection request packet.
- Responding computer or device confirms the disconnection request.
- The requesting computer or device acknowledges the confirmation.

1.5.3 Transport Protocol Data Unit (TPDU)

The format of a transport protocol data unit is shown in the figure 3.

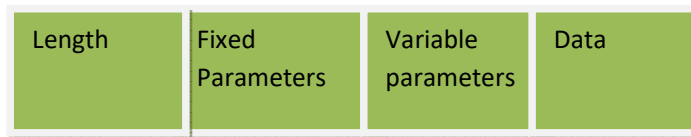

Space for learners

Figure 3: Format of TPDU

Length: The length field occupies the first byte and indicates the total number of bytes.

Fixed Parameters: The fixed parameters field contains parameters, or control fields, that are commonly present in all transport layer packets. It consists of five parts: code, source reference, destination reference, sequence number and credit allocation.

Variable parameters: This field contains parameters that occur infrequently. These control codes are used mostly for management.

Data: It contains regular data or expedited data coming from the upper layers. Expedited data consists of a high-priority message that must be handled out of sequence.

1.6 CONNECTION ORIENTED AND CONNECTIONLESS SERVICES

Connection oriented and Connectionless services are the two data transmission services provided by the network layer protocols and transport layer protocols. The Connection-oriented services establish a connection prior to sending the packets belonging to the same message from source to the destination. On the other hand, the connectionless service considers each packet belonging to the same message as a different & independent entity and route them with a different path.

In connection-oriented services, there is a sequence of operations:

1. Connection is established.
2. Information is sent.
3. Connection is released.

At first, we need to establish a connection, and then we can transfer data. Once data transfer is finished, then we use to terminate the connection. Example of connection oriented is TCP (Transmission Control Protocol) protocol. Connection oriented service is more reliable than connectionless service. We can send the data in connection-oriented service if there is an error at the receiver's end. Figure 4 shows an architecture of Connection oriented communication.

Space for learners

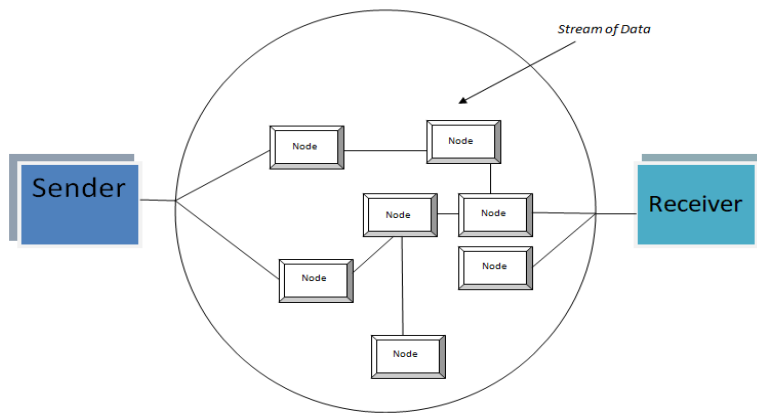

Fig 4: Connection Oriented Communication

Connection-oriented service interface is stream based and connectionless is message based. Each message is routed independently from source to destination. The order of packets of data sent can be different from the order of packets received in the receiver side. Unlike connection oriented, in connectionless service, authentication is not required i.e., without checking destination's existence data can be transferred in one direction. Example of Connectionless service is UDP (User Datagram Protocol) protocol. Figure 5 presents an architecture of Connection oriented communication.

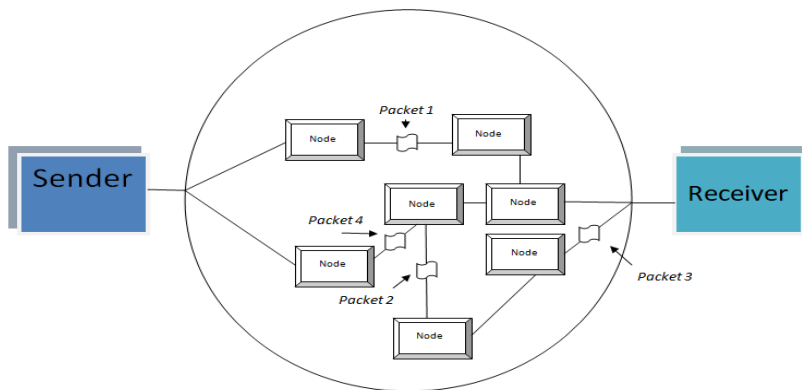

Figure 6: Connection-less Communication

1.7 VIRTUAL CIRCUIT VS DATAGRAM SUBNET

Computer networks that provide connection-oriented service are called Virtual Circuits (VC) while those providing connection-

Space for learners

oriented services are called as Datagram networks. For prior knowledge, the Internet which we use is actually based on connectionless i.e., datagram networks at network level as all packets from a source to a destination do not follow same path. Some important points about VC and datagram are given below:

Space for learners

1.7.1 Virtual Circuits

1. It is connection-oriented which means that there is a reservation of resources like buffers, CPU, bandwidth etc. for the time in which the newly setup virtual circuit is going to be used by a data transfer session.
2. First packet goes and reserves resources for the subsequent packets which as a result follow the same path for the whole connection time.
3. Since all the packets are going to follow the same path, a global header is required only for the first packet of the connection and other packets generally don't require global headers.
4. Since data follows a particular dedicated path, packets reach in to the destination.
5. From above points, it can be concluded that Virtual Circuits are highly reliable means of transfer.
6. Since each time a new connection has to be setup with reservation of resources and extra information handling at routers, so it is costlier to implement Virtual Circuits.

1.7.2 Datagram Networks

1. It is connectionless service. There is no need of reservation of resources as there is no dedicated path for a connection session.
2. All packets are free to go to any path on any intermediate router which is decided on the go by dynamically changing routing tables on routers.
3. Since every packet is free to choose any path, all packets must be associated with a header with proper information about source and the upper layer data.

4. The connectionless property makes data packets to reach the destination in any order, means they need not reach in the order in which they were sent.

5. Datagram networks are not reliable as Virtual Circuits.

6. But it is always easy and cost efficient to implement datagram networks as there is no extra headache of reserving resources and making a dedicated each time an application has to communicate.

Space for learners

CHECK YOUR PROGRESS - II

6: How we establish connection between sender and receiver?

7: What do you mean by connection-oriented service?

8: Write down the three differences between Virtual Circuit and Datagram Subnets.

1.7.3 Comparison of Virtual Circuit and Datagram Subnet

<i>Comparison</i>	Virtual Circuit	Datagram
Connection Setup	Required	None
Addressing	Packet Contains short virtual circuit number identifier.	Packet contains full source and destination address.
State Information	Each virtual circuit number entered to table on setup, used for routing.	None other than router table containing destination network.
Routing	Route established at setup, all packets follow same route.	Packets routed independently.
Effect of Router Failure	All virtual circuits passing through failed router terminated.	Only on packets lost during crash.
Congestion Control	Simple by pre-allocating enough buffers to each virtual circuit at setup, since maximum number of circuits fixed.	Difficult since all packets routed independently router resource requirements can vary.

1.8 SUMMING UP

The Network layer (layer 3) and transport layer (layer 4) are responsible for transferring data from end to end in a network. Network layer mainly decides which physical path the data will take and the transport layer simply transmits data using transmission protocols using TCP and/or UDP. The transport layer takes data

transferred in the session layer and breaks it into “segments” on the transmitting end. It is responsible for reassembling the segments on the receiving end, turning it back into data that can be used by the session layer. The transport layer carries out flow control, sends data at a rate that matches the connection speed of the receiving device, and error control, checking if data was received correctly and if not, requesting it again. The network layer has two main functions - One is breaking up segments into network packets, and reassembling the packets on the receiving end. The other is routing packets by discovering the best path across a physical network. The network layer uses network addresses (typically Internet Protocol addresses) to route packets to a destination node. This unit revolves around these two layers; we have studied some important topics. We have mainly studied the functionalities of network and transport layer, and then we have learnt about the connection establishment and termination. Lastly, we have discussed about virtual circuit and datagram subnets.

Space for learners

1.9 ANSWERS TO CHECK YOUR PROGRESS

1. The packet switching is a switching technique in which the data is transferred in one go, but it is divided into smaller pieces called packets, and they are sent individually.

2. Refer Section 1.4

3. In Flow and congestion control, mainly Traffic is controlled. In flow control, Traffic represents data flow from sender to receiver and in Congestion Control; Traffic represents flow entering into the network. Flow control is used to prevent the sender from overloading the receiver side. If it is overloaded, then the receiver discards the packets and asks for the retransmission of packets. This increases network congestion and thus, reducing the system performance. Congestion is a situation in which too many sources over a network attempt to send data and the router buffers start overflowing due to which loss of packets occur.

4. Refer Section 1.5.1

5. Some of the functionalities of network layer are –

- Internetworking
- Fragmentation

- Packetizing
- Network Layer protocols
- Guaranteed Delivery
- Routing
- Addressing

6. Before communicating device can send data to the other, the initializing device must first determine the availability of the other to exchange data and a pathway must be found through the network by which the data can be sent. This step is called connection establishment. Connection establishment requires three Transport Layer actions called three way handshaking -

- The computer requesting the connection sends a connection request packet to the intended receiver.
- The responding computer returns a confirmation packet to the requesting computer.
- The requesting computing returns a packet acknowledging the confirmation.

7. The Connection oriented services establish a connection prior to sending the packets belonging to the same message from source to the destination and it is more reliable than Connection less Services.

8. Differences between Virtual Circuit and Datagram Subnets are given below:

Virtual Circuit	Datagram Subnets
It is connection-oriented simply meaning that there is a reservation of resources like buffers, CPU, bandwidth etc. for the time in which the newly setup virtual circuit is going to be used by a data transfer session.	It is connectionless service. There is no need of reservation of resources as there is no dedicated path for a connection session.
First packet goes and reserves resources for the subsequent packets which as a result follow the same path for the whole connection time.	All packets are free to go to any path on any intermediate router which is decided on the go by dynamically changing routing tables on routers.

Space for learners

Virtual Circuits are highly reliable means of transfer.	Datagram networks are not reliable as Virtual Circuits.
---	---

Space for learners

1.10 POSSIBLE QUESTIONS

1. Write down the main roles of Network Layer.
2. Explain the services of Transport Layer.
3. What do you mean by Packet Switching? Explain Store and Forward Techniques.
4. How a connection-oriented service establish a path between sender and receiver?
5. What do you mean by Transport Protocol Data Unit?
6. Write down the differences between Connection Oriented and Connection Less Service.
7. How Reliable delivery from sender to receiver can be achieved?
8. Write down the services of the Network Layer.
9. What is the difference between Packets and Segments?
10. What is the fragmentation in Network Layer?
11. Explain Datagram Subnets.
12. Explain Virtual Circuit.
13. Distinguish between Virtual Circuit and Datagram Subnets.
14. What do you mean by End-to-End Delivery?
15. Explain about Multiplexing technique in the Transport Layer.

1.9 REFERENCES AND SUGGESTED READINGS

1. Computer networks / Andrew S. Tanenbaum, David J. Wetherall. -- 5th ed.
2. Data Communications and Networking - Behrouz A. Forouzan
3. Computer Networking: A Top-Down Approach - Jim Kurose
4. <https://www.geeksforgeeks.org/>
5. <https://www.studytonight.com/>

6. <https://www.javatpoint.com/>
7. <https://jyotinivas.org/>
8. <https://www.tutorialspoint.com/>
9. Lecture notes on Virtual Circuit v/s Datagram Subnets - Mrs. Shakti Pandey, J.D. Women's college, Patna
10. <http://what-when-how.com/>
11. <https://www.imperva.com/>

Space for learners

UNIT 2: THE NETWORK LAYER: ROUTING

Space for learners

Unit Structure:

- 2.1 Introduction
- 2.2 Unit Objectives
- 2.3 Concepts of Routing & Congestion
- 2.4 Routing Algorithms- Adaptive and Non-adaptive
- 2.5 The Optimality Principle
- 2.6 Shortest Path Routing
 - 2.6.1 Dijkstra's Algorithm
 - 2.6.2 Bellman Ford's Algorithm
 - 2.6.3 Floyd Warshall's Algorithm
- 2.7 Flooding
- 2.8 Distance Vector Routing
- 2.9 Link State Routing
- 2.10 Hierarchical Routing
- 2.11 Unicast, Broadcast and Multicast Routing
- 2.12 Queuing Theory
- 2.13 Summing Up
- 2.14 Answers to Check Your Progress
- 2.15 Possible Questions
- 2.16 References and Suggested Readings

2.1 INTRODUCTION

The main responsibility of the network layer is the source-to-destination delivery of a packet via multiple networks or links. The data link layer, on the other hand, is responsible for delivery of a packet on the same network or links. The network layer focuses on each packet which originates from its source must reach its final destination host. When a device finds that there are multiple paths to reach a destination, it selects a path (preferably the best one) over others. This mechanism of selecting the possible best path is termed as *routing*, one of the functions of the network layer. The routing process is performed by network layer (layer 3) devices such as a router or a layer 3 switch.

2.2 UNIT OBJECTIVES

After completing this unit, you will be able to learn:

- Why routing is needed?
- Goals of routing
- Basic concepts of congestion
- Adaptive and Non-adaptive Algorithms used for Routing
- The concept of the optimality principle
- Various widely used shortest path routing algorithms and their working rules.
- Unicast, broadcast, multicast and hierarchical routing
- Applications of queuing theory in computer networks

2.3 CONCEPTS OF ROUTING & CONGESTION

In case, if all hosts (systems) are attached to a same single physical segment, then there is no need of routers or any routing protocols to communicate within them. Figure 2.1 presents a scenario where all the hosts are present on the same segment and they can communicate among them without any router or any routing algorithm.

Routing involves the delivery of packets or datagrams between end systems situated on different networks. It is a process or mechanism to choose an optimal path between the source and destination which is performed by a device which works on network layer (layer 3). Figure 2.2 depicts how a router provides physical connection between different subnets or different networks to communicate from one end to the other end. Routers are configured with some type of routing algorithm to enable communication between hosts when they are situated outside the local segment.

Space for learners

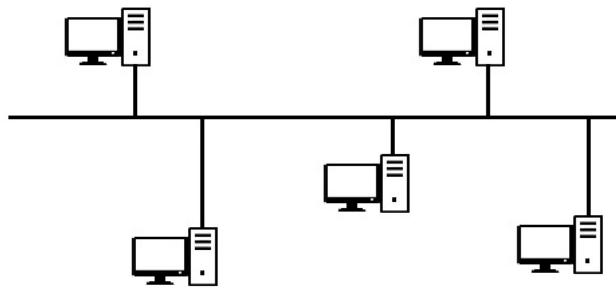

Figure 2.1: All systems located on a single segment

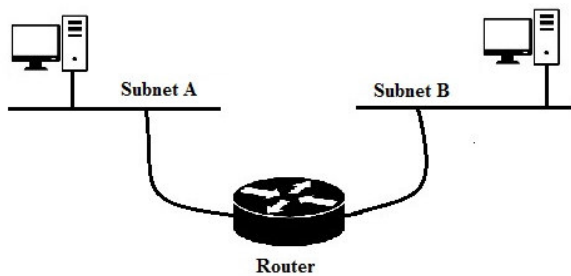

Fig 2.2: Different subnets connected by Router

There are some major goals of routing, which are:

- **Correctness:** Routing should be done properly and accurately so that the packets may reach their destination correctly.
- **Simplicity:** The network overhead increases with increasing the complexity of the routing algorithms. That is why Routing should be done in a simple manner to keep the overhead as low as possible.
- **Robustness:** The routing algorithms should be robust enough to handle the changes in the network topology and should be able to handle any failures in software or hardware without the need to abort all the jobs in all hosts and without rebooting the network whenever a router goes down.
- **Stability:** Under all possible conditions the routing algorithms should be stable.
- **Fairness:** Each and every node present in the network should get a fair chance of transferring its packets; which is usually done on a first come first serve basis.

Space for learners

- **Optimality:** Routing algorithms should be optimal in terms of increasing the throughput and minimizing the mean packet delays. There is a trade-off here and one has to choose which one is more suitable as per need.

On the other hand, congestion is a state of the network which deteriorates the network service because of carrying high amount of data which may lead to packet loss or frame loss. When congestion occurs in a network, the throughput of the network decreases along with the response time. In a network, congestion may occur when the allotted bandwidth becomes insufficient as the data traffic exceeds the capacity of the network bandwidth.

Congestion in a network may lead to *congestion collapse*- a condition in which the useful communication gets limited or prevented. Network congestion and collapse can be avoided by the following ways:

- When the router detects that critical level (exceeding the handling capacity) is reached while receiving the data packets, the router should be capable of dropping or reordering the packets.
- Use of any flow control mechanisms to respond efficiently whenever data flow rates reach the critical level or exceeds the handling capacity.

Space for learners

CHECK YOUR PROGRESS

1. The mechanism of selecting the best possible path is termed as _____.
a) Congestion b) Routing
c) Path finding d) None of these
2. Which one is **not** a goal of routing?
a) Correctness b) Optimality
c) Robustness d) Complexity
3. Router is a _____ device.
a) layer 1 b) layer 2
c) Layer 3 d) Layer 7
4. **State TRUE or FALSE:**
a) Congestion in a network may lead to congestion collapse.
b) Routing deteriorates the network service.
c) Congestion increases and accordingly throughput increases.

2.4 ROUTING ALGORITHMS

So far, we have learnt that Routing is the mechanism to forward the data packets from source to destination. But in order to find the best route or path from source to destination the network layer uses various routing algorithms or routing protocols through which the data packets can be transmitted. The routing algorithms can be classified as:

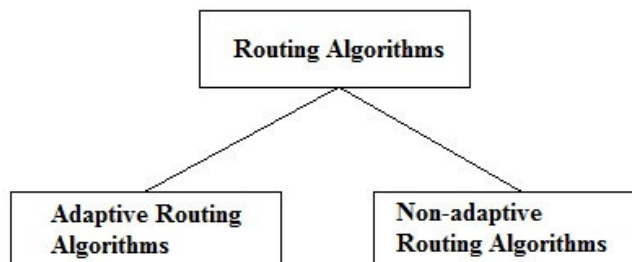

Adaptive Routing Algorithms:

Whenever there is a change in the network topology or the network traffic load, these algorithms change their routing decisions. That is why, these algorithms are also known as dynamic routing algorithms. The main parameters considered by these algorithms while updating the routing table are hop count, distance measure, estimated transmit time and delay etc. Furthermore, the adaptive algorithms can be classified into three categories which is shown below.

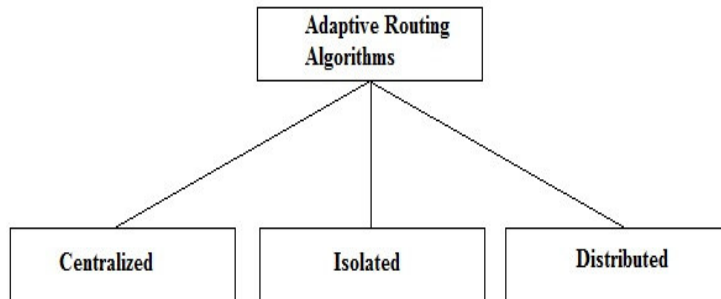

Centralized algorithms:

In centralized algorithm, there is a centralized node which has all the necessary global information related to the network and based on that it takes all the routing decisions to find the best route or optimal path. So, it is also termed as global routing algorithm. As the involvement of other nodes is very less, the resource requirement becomes very less too as all information are stored in the centralized node only. However, if only the central node goes down then the whole routing fails as the performance is too much dependent on the central node only. Centralized algorithms need to aware the cost of the links prior to performing any calculations. *Link State Routing* is one example of such algorithm which is aware of the costs of the paths or links present in the network.

Isolated algorithms:

In isolated routing, the routing decisions are made based on the local information available to them instead of seeking those from other nodes. Here, any information regarding the status of the links or paths is not known. Though this helps in making the routing decision faster but these algorithms may result in delay as the nodes may transmit data through a congested network. Some examples of

Space for learners

this type of algorithm for routing are: *Hot Potato* and *Backward Learning*. In hot potato algorithm, when a packet arrives to a node, it tries to get rid of that packet as fast as it can, by sending it on the shortest output queue without considering where that link leads. In backward learning algorithm, the routing table at each node is updated by the information it receives from the incoming packets. Backward learning can be implemented by including the identity of the source node in each packet with a hop counter that is incremented with each hop. When a node receives a packet, it counts the number of hops it has passed through from the source node to reach it. If the previous hop count value is found better than the current value then it does nothing, but if the current value is found better than the previous one then the value is updated for future use.

Distributed Algorithms:

In distributed routing algorithms, the nodes gather the information from their neighbors and based on that, the decision is taken which way to transmit the packet. It is also called as decentralized algorithm as no node has all the information related to cost of all the paths from source to destination. A node has the information of its directly connected nodes only and the complete least-cost path to the destination is calculated in an iterative and distributed manner. *Distance Vector Routing* is an example of this category where it never knows the complete path from source to destination. So, it forwards the packet to the direction through which the packet to be transmitted finding the least-cost path.

Non-adaptive Routing Algorithms:

The non-adaptive routing algorithms are also termed as static routing algorithms as they do not change their routing decisions based on the variations on the network traffic and topology. In fact, the route to be chosen to transmit packets from one node to another is determined in advance. The static routing table is formulated depending on the routing information stored in the routers when the network is booted. Once the static paths are computed and made available to all the routers, they start transmitting the packets through these paths. The routing decisions remain unaffected to any changes in the network. Non-adaptive routing algorithms can further be categorized as:

Space for learners

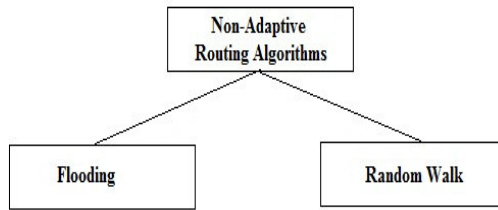

Space for learners

Flooding uses the technique in which a node forwards every incoming packet to every outgoing line except the one through which it arrived. Flooding in more detail will be discussed later on this unit.

Random Walk is a highly robust algorithm in which a node forwards a packet to one of its neighbours randomly. This is a probabilistic protocol to select the next random node to forward the data packet, so it does not have the need of any global information.

2.5 THE OPTIMALITY PRINCIPLE

A routing algorithm enables a router to find the output path through which an incoming packet can be forwarded. The path should be a least cost or optimal path. The optimality principle states that:

Given a network of routers, if a router 'J' lies on the optimal path from router 'I' to router 'K', then the optimal path to router 'J' to router 'K' also lies on the same route.

The optimality principle logically implies that:

If a better route between router J and router K is obtained and updated then the path from router I to router K is also updated via the same route. To understand this, let's consider an example:

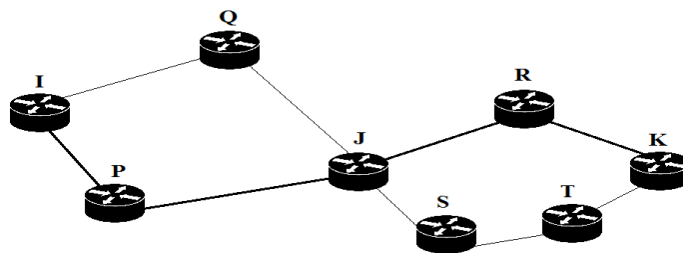

(a)

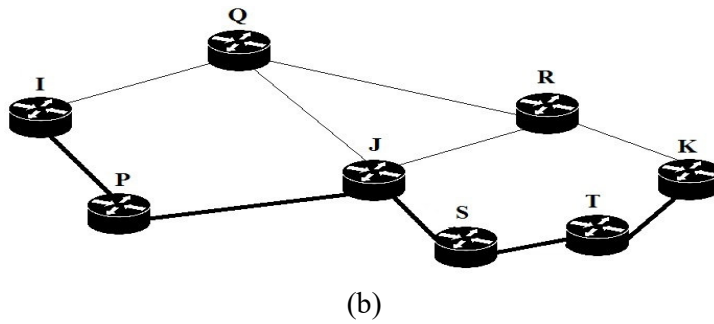

Fig 2.3(a), (b): Optimal paths

Suppose there is a network of routers I-P-Q-J-R-S-T-K as shown in figure 2.3 a & b. In case of figure 2.3 a, let's consider the optimal path from router I to router K be via I-P-J-R-K which is shown in bold line. Here, according to optimality principle the optimal path from router J to router K will also fall on the same route which is J-R-K.

Now, suppose a better route from router J to router K is found via J-S-T-K and updated as optimal route to router J to router K, then the optimal route from router I to router K is also updated via that route which becomes I-P-J-S-T-K.

Space for learners

CHECK YOUR PROGRESS

5. Adaptive routing algorithms are also termed as _____ algorithms.
 - a) Static Routing
 - b) Dynamic Routing
 - c) Fixed Routing
 - d) None of these
6. Link State Routing is an example of _____ algorithms.
 - a) Distributed adaptive routing
 - b) Non- adaptive routing
 - c) Centralized adaptive routing
 - d) Isolated adaptive routing
7. **State TRUE or FALSE:**
 - a) Non-Adaptive routing algorithms are also termed as dynamic routing algorithms.
 - b) Flooding is an example of adaptive routing algorithms.
 - c) Optimality principle helps to find and update least cost path.

2.6 SHORTEST PATH ROUTING

The goal of the shortest path routing is to minimize the routing cost by obtaining the shortest path between the nodes by applying some graph theory approaches. Some of the shortest path routing algorithms are:

- Dijkstra's Algorithm
- Bellman Ford's Algorithm
- Floyd Warshall's Algorithm

2.6.1 Dijkstra's Algorithm

This algorithm finds the shortest path from a single node (source) to all other nodes (vertices) in a weighted graph. Let's understand the working of Dijkstra's algorithm with an example.

The Algorithm:

1. Find a shortest-path tree set (*SPT*) that keeps track of vertices included in the shortest-path tree, Initially, this set is empty.
2. The distances from the Source Node to all other vertices are set to ∞ .
3. While *SPT* doesn't include all vertices
 - a) Pick a vertex *u* which is not there in *SPT* and has a minimum distance value.
 - b) Include *u* to *SPT*.
 - c) Update distance value of all adjacent vertices of *u*. To update the distance values, iterate through all adjacent vertices. For every adjacent vertex *v*, if the sum of distance value of *u* (from source) and weight of edge *u - v* which is given by $c(u, v)$, is less than the distance value of *v*, then update the distance value of *v*. That means If $d(u) + c(u, v) < d(v)$ then $d(v) = d(u) + c(u, v)$ [*principle of relaxation*].

Consider the following graph:

Space for learners

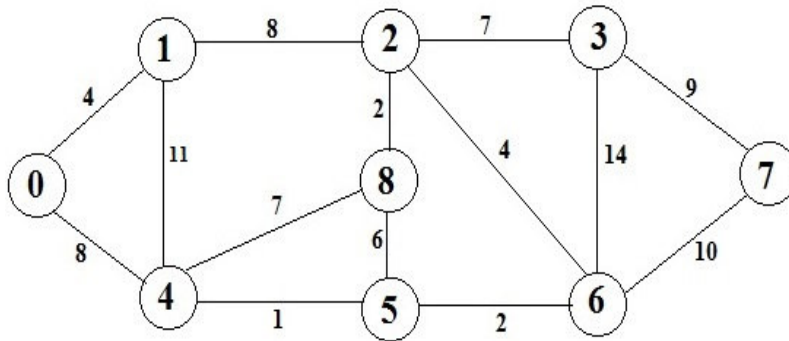

Space for learners

For the above weighted graph let's consider the Node 0 be the source node from which the shortest paths to all other vertices are to be found using Dijkstra's algorithm.

Initially *SPT* is kept empty and distances assigned to vertices are $[0, \infty, \infty, \infty, \infty, \infty, \infty, \infty]$. The vertex 0 is picked as source node, included it to the *SPT*. So *SPT* becomes $[0]$. After inserting node 0 to *SPT*, the distances of its adjacent vertices are updated. The adjacent vertices of node 0 are node 1 and node 4. The distance values of node 1 is updated as 4 as $d(u) + c(u, v) = 0 + 4 = 4$ which is less than $d(v) = \infty$. Similarly, the distance value of node 4 is also updated as 8. The following sub graph shows the vertices and their distance values. Bold vertices are added to the *SPT*.

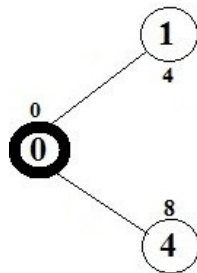

Next, select the vertex with minimum distance value which is not already included in the *SPT*. The vertex 1 is selected and inserted into *SPT*. Now the *SPT* becomes $[0, 1]$. The distance values of the adjacent vertices of node 1 are updated, so the distance value of node 2 becomes 12.

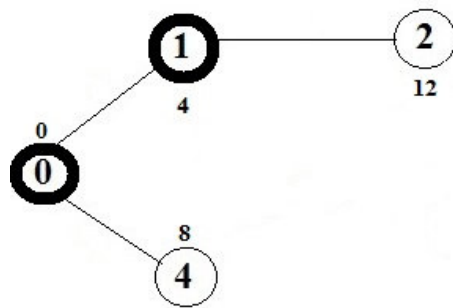

Next, select the vertex with minimum distance value which is not already included in the SPT. The vertex 4 is selected and inserted into SPT. Now the SPT becomes [0, 1, 4]. The distance values of the adjacent vertices of node 4 are updated. So, the distance values of node 5 and node 8 are updated as 9 and 15 respectively.

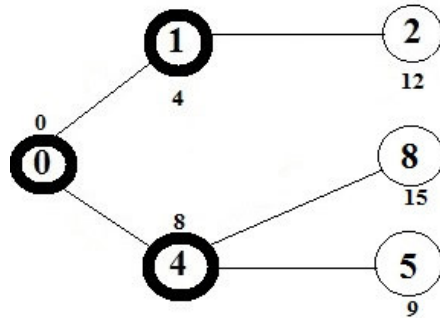

Next, select the vertex with minimum distance value which is not already included in the SPT. The vertex 5 is selected and inserted into SPT. Now the SPT becomes [0, 1, 4, 5]. The distance values of the adjacent vertices of node 5 are updated. So, the distance value of node 6 is updated as 11 and the distance value of node 8 is remained unaffected.

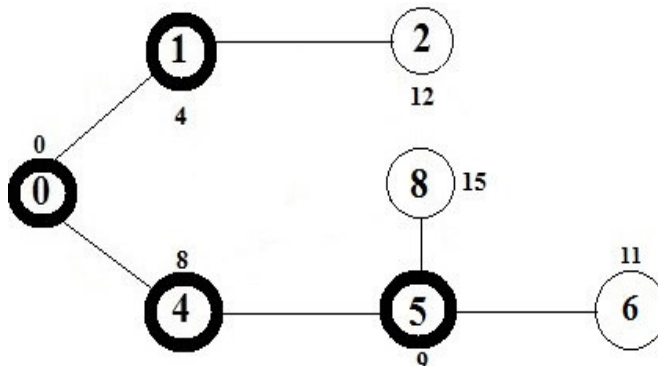

Space for learners

The steps are repeated iteratively until we get all the vertices inserted in the SPT. Finally, the following SPT is found:

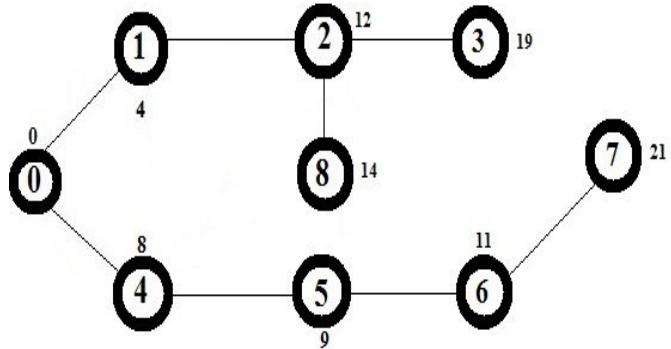

The weights written outside the nodes indicate the shortest distance from the source node (node 0) in the above example.

2.6.2 Bellman Ford's Algorithm

Dijkstra algorithm finds the shortest paths from the source node to all other target nodes but it may fail to find the shortest paths in the graphs having negative weights. Bellman Ford's algorithm works correctly for such graphs. But it is also noteworthy that Bellman Ford's algorithm is slower than Dijkstra's algorithm. The working principle of the Bellman Ford's algorithm is based on the *principle of relaxation* which states that if $d(u) + c(u, v) < d(v)$ then $d(v) = d(u) + c(u, v)$ for every adjacent vertex v from source u .

Algorithm

1. Initialize distances from the source node to all other vertices as ∞ and distance from the source to itself as 0. Create and initialize array $dist[]$ of size $|V|$ with all values as ∞ except $dist[src]$ where src is source vertex and $|V|$ is the number of vertices in given graph.
2. Calculate shortest distances for $|V|-1$ times where
 - a) Do the followings for each edge $u - v$

if $dist(u) + cost(u, v) < dist(v)$

then $dist(v) = dist(u) + cost(u, v)$
3. This step ensures if there is any negative weight cycle in graph. To find that we iterate through all edges and

Space for learners

calculate the shortest path once again and if we get a shorter path for any node, then there is a negative weight cycle.

Let's understand this algorithm with the help of an example:

Consider the following graph:

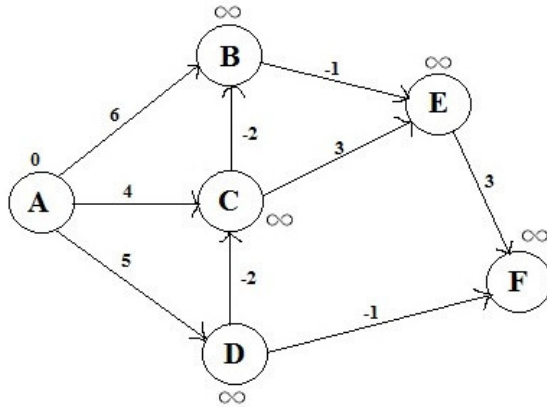

Initially,

A	B	C	D	E	F
0	∞	∞	∞	∞	∞

The graph has $|V|=6$, so there will be 5 ($|V|-1$) iterations.

For the iteration 1,

The edges (A,B), (A,C), (A,D), (B,E), (C,E), (D,C), (D,F), (E,F), (C,B) are processed. The order can be as per your choice.

For edge (A,B):

$u = A$ and $v = B$

$dist(u) + cost(u, v) = 0 + 6 = 6$ which is $< \infty$

So, $dist(v)$ is updated. Hence $B=6$

Similarly, if we process other edges the updates will be

For (A,C), $C = 4$,

For (A,D), $D = 5$,

For (B,E), $E = 5$,

For (C,E), E is not updated,

For (D,C), $C = 2$ (updated again),

For (D,F), $F = 4$,

For (E,F), F is not updated,

For (C,B), $B = 1$ (updated once again).

After the completion of iteration 1:

Space for learners

A	B	C	D	E	F
0	1	2	5	5	4

For the iteration 2,

The edges (A,B), (A,C), (A,D), (B,E), (C,E), (D,C), (D,F), (E,F), (C,B) are processed again. The updated costs are:

A	B	C	D	E	F
0	1	2	5	0	3

For the iteration 3,

The edges (A,B), (A,C), (A,D), (B,E), (C,E), (D,C), (D,F), (E,F), (C,B) are processed again. The updated costs are:

A	B	C	D	E	F
0	1	2	5	0	3

For the iteration 4,

The edges (A,B), (A,C), (A,D), (B,E), (C,E), (D,C), (D,F), (E,F), (C,B) are processed again. The updated costs are:

A	B	C	D	E	F
0	1	2	5	0	3

For the iteration 5,

The edges (A,B), (A,C), (A,D), (B,E), (C,E), (D,C), (D,F), (E,F), (C,B) are processed again. The updated costs are:

A	B	C	D	E	F
0	1	2	5	0	3

As you can see after iteration 3 the updating is not performed. But as per algorithm the iterations to be performed is $|V|-1$ times that is why we performed 5 iterations. There is a drawback of the algorithm that it may produce negative weight cycle in some of the cases.

2.6.3 Floyd Warshall's Algorithm

This algorithm is used to find all pair shortest paths. Unlike Dijkstra where shortest paths are found from just a single source, *Floyd Warshall's Algorithm* finds shortest paths from each of the vertices to all other vertices in just a single run. Let's understand the working of the algorithm with the help of an example.

Space for learners

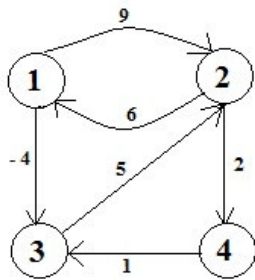

Space for learners

Considering the above directed weighted graph and let's apply the *Floyd Warshall's Algorithm* to find all pair shortest paths.

Initially a D^0 distance matrix is formed which includes distances to and from all the vertices.

	1	2	3	4
1	0	9	-4	∞
2	6	0	∞	2
3	∞	5	0	∞
4	∞	∞	1	0

Here, distance from node 1 to 1 is 0 and if there is no direct link to other nodes or vertex then that distance is considered as ∞ . Using this D^0 matrix, another distance matrix D^1 is formed, using D^1 , D^2 matrix is formed and like way depending on the number of total vertices available in the graph other matrices are formed. In this case, there will be four distance matrices (D^1 , D^2 , D^3 and D^4).

D^1 Matrix:

The matrix D^1 is calculated using the matrix D^0 . While calculating matrix D^1 , node 1 is considered as an intermediate node to reach other vertices.

	1	2	3	4
1	0	9	-4	∞
2	6	0	2	2
3	∞	5	0	∞
4	∞	∞	1	0

As you can see, the distance from 2 to 3 which is indicated by $D^1(2,3)$ is updated to 2 (earlier it was ∞).

As node 2 to node 3 can be reached via the intermediate node 1, so

$$D^1(2,3) = D^0(2,1) + D^0(1,3) \quad [\text{node 1 is intermediate}]$$

$$\infty > 6 + (-4) \quad [\text{Values are put using } D^0 \text{ matrix}]$$

$$\infty > 2$$

As we have found a lesser value than ∞ , so it is updated.

Let's find $D^1(2,4)$, which means finding path from node 2 to node 4 keeping node 1 as intermediate node.

$$D^1(2,4) = D^0(2,1) + D^0(1,4)$$

$$2 < 6 + \infty$$

$$2 < \infty$$

As there is no direct path from node 1 to node 4, so the value $D^0(1,4)$ becomes ∞ and this results that the previous value of $D^1(2,4)$ will not be updated. And similarly, rest other values are also not updated in the matrix D^1 .

D² Matrix

	1	2	3	4
1	0	9	-4	11
2	6	0	2	2
3	11	5	0	7
4	∞	∞	1	0

As we can see matrix D^2 is updated with a lot of changes keeping node 2 as intermediate node, let's evaluate one value, say $D^2(3,1)$.

$$D^2(3,1) = D^1(3,2) + D^1(2,1)$$

$$\infty > 5 + 6$$

$$\infty > 11$$

So, $D^2(3,1)$ is updated to 11.

D³ Matrix:

Matrix D^3 is updated keeping node 3 as intermediate node.

The resultant D^3 is:

	1	2	3	4
1	0	1	-4	3
2	6	0	2	2
3	11	5	0	7
4	12	6	1	0

D⁴ Matrix:

Matrix D^4 is updated keeping node 4 as intermediate node.

The resultant D^4 is:

	1	2	3	4
1	0	1	-4	3
2	6	0	2	2
3	11	5	0	7
4	12	6	1	0

As we have four vertices in the graph, we have to find 4 distance matrices. And this D^4 matrix will give us all pairs of shortest paths from any vertex as source vertex.

Suppose we take vertex 3 as source vertex then the shortest paths to all other vertices can be found using D^4 , and these are:

$$3 \rightarrow 1 = 11$$

$$3 \rightarrow 2 = 5$$

$$3 \rightarrow 4 = 7$$

Space for learners

CHECK YOUR PROGRESS

8. Principle of relaxation is:
- If $d(u) + c(u, v) < d(v)$ then $d(v) = d(u) + c(u, v)$
 - If $d(u) + c(u, v) > d(v)$ then $d(v) = d(u) + c(u, v)$
 - If $d(u) + c(u, v) > c(u, v)$ then $d(v) = d(u) + c(u, v)$
 - None of these
9. Single Source shortest path algorithms
- Find shortest path to all vertices from many sources
 - Find shortest path to all vertices from single source
 - Find all pair shortest paths from all vertices
 - None of these
10. State TRUE or FALSE:
- Bellman Ford's algorithm is faster than Dijkstra's algorithm.
 - Dijkstra's algorithm works well with graphs having negative weights.
 - Floyd Warshall's Algorithm finds all pair shortest paths.

2.7 FLOODING

Flooding is a non-adaptive routing algorithm which states that whenever a packet arrives at a router, it is forwarded to all the outgoing links of the router except the link through which the packet arrived. Let's consider the following network of 7 routers:

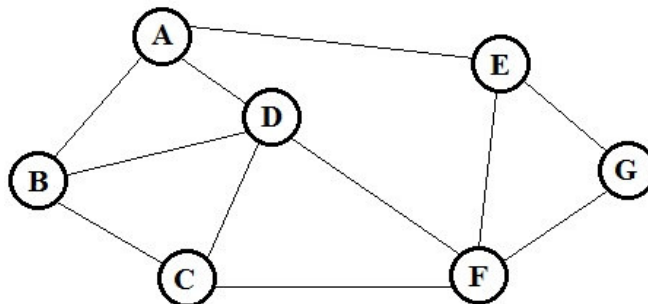

If flooding is applied to the above network, then

- An incoming packet to router A will be forwarded to router B, D and E,
- B again will forward the packet to C and D,
- D will forward the packet to C and F,
- C will forward the packet to F,
- F will forward the packet to E and G,
- E will forward the packet to G

Though flooding is a very simple and robust algorithm, here, we can see that a router may receive duplicate packets from other routers which is a disadvantage of flooding. Using a technique called *Hop Count*, this can be solved. The *Hop Count* is a counter attached with the packet which is decremented each time the packet passes through a router. Whenever it reaches Zero, the packet is discarded.

Types of Flooding:

Three types of flooding techniques are there.

- **Uncontrolled Flooding:** An incoming packet to a router is transmitted unconditionally to all the neighbours.
- **Controlled Flooding:** Here, some methods are used to control the forwarding of the packets to its neighbours. Sequence Number Controlled Flooding (SNCF) and Reverse Path Forwarding (RPF) are two popular controlled flooding algorithms.
- **Selective flooding:** This variant of flooding does not directly forward the packets to all the neighbors; instead, it only uses those lines which are linked to the routers that are approximately in the same direction as the recipient node.

2.8 DISTANCE VECTOR ROUTING

Distance vector routing algorithm is an asynchronous dynamic algorithm in which a node or a router 'X' sends the copy of its distance vector to all its neighbours. Node 'X' also receives the new distance vector from one of its neighbouring nodes, saves the distance vector and uses the Bellman-Ford's equation to find the shortest paths and update its own distance vector. When router X updates its own routing table, then it also sends the distance vector

to all of its neighbours to update their routing tables. Like this, the routing tables of all the nodes are updated. The working of this algorithm is based on exchange of the distance vectors among the nodes and that is why this algorithm is called Distance Vector Routing algorithm.

Important Steps of the algorithm:

1. A router exchanges its distance vector (included in a routing packet) to each of its direct neighbors.
2. Each router saves the most recently received distance vector from each of the neighbors.
3. Any router present in the network recalculates its distance vector when:
 - The distance vector received from a neighbor contains different information than before.
 - It discovers a link failure in the network.

When a router x receives new Distance Vector estimate from any neighbor v, it saves v's distance vector and updates its own Distance Vector using the Bellman-Ford's equation:

$$D_x(y) = \min \{ C(x, v) + D_v(y), D_x(y) \} \text{ for each node } y \in N$$

Let's understand the working of this algorithm with the help of an example.

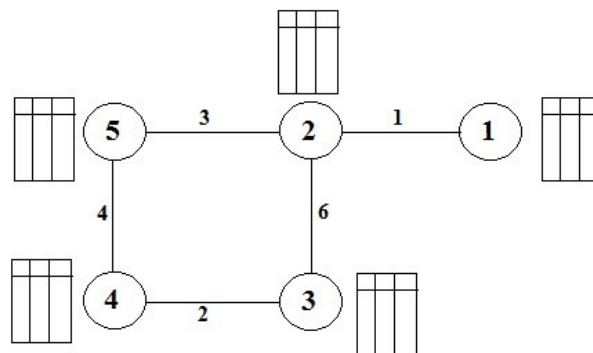

The above network has 5 routers and each router has its own routing table. A routing table as shown below contains at least three entries.

Destination	Cost	Next Hop
Node 1	-	-
Node 2	-	-
.	-	-
.	-	-
Node N	-	-

Here, Destination field refers to the destination from the source router, Cost refers to the distance or cost of the path upto that destination and Next Hop signifies the next node or next router through which the destination is reached.

First of all, each router or node creates its own routing table locally.

Routing table of node 1:

Destination	Distance	Next Hop
Node 1	0	Node 1
Node 2	1	Node 2
Node 3	∞	-
Node 4	∞	-
Node 5	∞	-

In this routing table of node 1, the distance from node 1 to itself is 0 and distance from node 1 to node 2 is 1 where the next hop is node 2. But other nodes like node 3, node 4 and node 5 are not reachable directly from node 1, so the cost is kept as ∞ and the next hop are unknown. Like this, other nodes also create their own routing tables.

Routing table of node 2:

Destination	Distance	Next Hop
Node 1	1	Node 1
Node 2	0	Node 2
Node 3	6	Node 3
Node 4	∞	-
Node 5	3	Node 3

Space for learners

Routing table of node 3:

Destination	Distance	Next Hop
Node 1	∞	-
Node 2	6	Node 2
Node 3	0	Node 3
Node 4	2	Node 4
Node 5	∞	-

Routing table of node 4:

Destination	Distance	Next Hop
Node 1	∞	-
Node 2	∞	-
Node 3	2	Node 3
Node 4	0	Node 4
Node 5	4	Node 5

Routing table of node 5:

Destination	Distance	Next Hop
Node 1	∞	-
Node 2	3	Node 2
Node 3	∞	-
Node 4	4	Node 4
Node 5	0	Node 5

Now, keep it in mind that only the distance column (not the whole routing table) of the routing tables is shared with the adjacent neighbours, which is known as the *Distance Vector*. After receiving these distance vectors from their neighbours, routers update their routing tables and again share the distance vectors with its neighbours and this process goes on until there is no change in the distance vector.

Let's consider some scenarios while sharing the distance vector

- Router 1 will receive the distance vector from router 2 only, as it is the only adjacent neighbour.
- Router 2 will receive the distance vectors from router 2, router 3 and router 5.

Space for learners

- Router 3 will receive the distance vectors from router 4 and router 5.
- Router 4 will receive the distance vectors from router 3 and router 5.
- Router 5 will receive the distance vectors from router 2 and router 4.

After getting all the distance vectors, all nodes updates their routing tables and again the updated distance vectors are shared with the neighbours.

Let's look at the update process of router 1.

The Distance vector received from router 2 is:

Distance
1
0
6
∞
3

This will be used to update the routing table of router 1. And the updated table is:

Destination	Distance	Next Hop
Node 1	0	Node 1
Node 2	1	Node 2
Node 3	7	Node 2
Node 4	∞	-
Node 5	4	Node 2

We can see that the routing table is updated. Let's see how it's done.

Node 1	0	Node 1
--------	---	--------

As we know that the distance from node 1 to node 1 the distance is 0, so it is not updated.

Node 2	1	Node 2
--------	---	--------

Node 2 can be reached via Node 1 \rightarrow Node 2 and Node 2 \rightarrow Node 2 path.

Distance of Node 1 \rightarrow Node 2 = 1 and

distance of Node 2 \rightarrow Node 2 = 0

So, total distance = 1 + 0 = 1.

Node 3	7	Node 2
--------	---	--------

Node 3 can be reached via Node 1 \rightarrow Node 2 and Node 2 \rightarrow Node 3 path.

Distance of Node 1 \rightarrow Node 2 = 1 and

Distance of Node 2 \rightarrow Node 3 = 6 [found form the received Distance vector]

So, total distance = 1 + 6 = 7.

Node 4	∞	-
--------	----------	---

Node 4 can be reached via Node 1 \rightarrow Node 2 and Node 2 \rightarrow Node 4 path.

Distance of Node 1 \rightarrow Node 2 = 1 and

Distance of Node 2 \rightarrow Node 4 = ∞ [found form the received Distance vector]

So, total distance = 1 + ∞ = ∞ .

This specifies that Node 4 is actually not reachable from Node 1.

Node 5	4	Node 2
--------	---	--------

Node 5 can be reached via Node 1 \rightarrow Node 2 and Node 2 \rightarrow Node 5 path.

Distance of Node 1 \rightarrow Node 2 = 1 and

Distance of Node 2 \rightarrow Node 5 = 3 [found form the received Distance vector]

So, total distance = 1 + 3 = 4

Thus, the routing table is updated in router 1.

Let's take one more case how the routing table of router 5 will be updated.

The Router 5 will receive two distance vectors each from Router 2 and Router 4. These are:

Space for learners

Node 2	Node 4
Distance	Distance
1	∞
0	∞
6	2
∞	0
3	4

The updated routing table will be:

Destination	Distance	Next Hop
Node 1	4	Node 2
Node 2	3	Node 2
Node 3	6	Node 4
Node 4	4	Node 4
Node 5	0	Node 5

Let's find out how it's updated:

Node 1	4	Node 2
--------	---	--------

Node 5 to Node 1 can be reached via

Path 1: Node 5 \rightarrow Node 2 and Node 2 \rightarrow Node 1.

Path 2: Node 5 \rightarrow Node 4 and Node 4 \rightarrow Node 1.

Path 1:

Distance of Node 5 \rightarrow Node 2 = 3 [known already from its RT]

Distance of Node 2 \rightarrow Node 1 = 1 [found from the received Distance vector from Node 2]

So, total distance = 3 + 1 = 4

Path 2:

Distance of Node 5 \rightarrow Node 4 = 4 [known already from its RT]

Distance of Node 4 \rightarrow Node 1 = ∞ [found from the received Distance vector from Node 4]

So, total distance = 4 + ∞ = ∞

From the two possible cases the least distance is kept, and it is 4. So, the updated distance becomes 4.

Space for learners

Like this, all other entries of the routing table are updated.

This process of updating the routing table goes on each node unless there are no more modifications in the shared distance vectors.

2.9 LINK STATE ROUTING

Link state routing is another routing protocol that has a different philosophy than the distance vector routing. Here, instead of sending a routing table, a node or a router sends some information which is called a *Link State Packet (LSP)* to its neighbourhood using *flooding* and for updating the routing table, a router can use Dijkstra's algorithm to find the shortest paths. The Link State Packet carries information about the node identity, sequence number, age and the list of links. So, every node has global knowledge about the network because of the sharing of this LSP packet which is not there in distance vector routing.

Four sets of actions are performed to create the routing table at each node showing the least-cost node to every other node.

1. Creation of the Link State Packet (LSP).
2. Using Flooding in an efficient way distribution of LSPs to every other node.
3. Calculation of shortest path tree at each node (using Dijkstra's algorithm)
4. Formation of Routing Table based on the shortest path tree.

Let's understand the working of this algorithm with the help of an example:

Consider the following network of 6 routers:

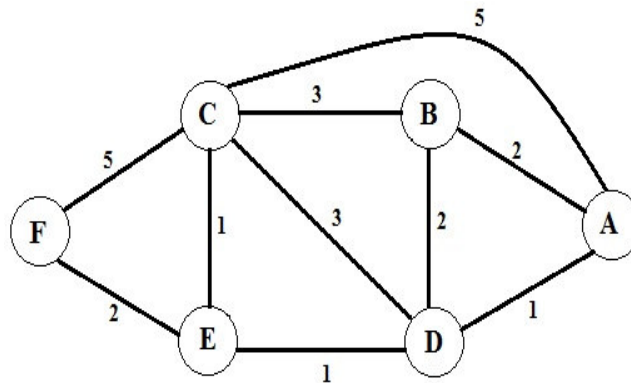

Space for learners

Considering the router, A, as the source router let's proceed step by step:

STEP 1:

This is initialization step. Source **A** has direct neighbours **B, D,** and **C** and the least cost path to reach them are 2, 1 and 5 respectively. Step 1 produces the following:

N	D(B), P(B)	D(C), P(C)	D(D), P(D)	D(E), P(E)	D(F), P(F)
A	2, A	5, A	1, A	∞	∞

Here,

N represents the node processed.

$D(v)$ represents the distance/ cost from the source node to node v ,

$P(v)$ represents the previous node (neighbour of v) from the source node along the least cost path.

STEP 2:

We can see in the above table from step 1 that node **D** has the shortest path, there for it is added in N. Now, the shortest path to other nodes will be calculated trough node **D**.

Calculating shortest path from **A to B:**

$$D(B) = \min(D(B) , D(D) + \text{cost}(D, B))$$

$$D(B) = \min(2, 1 + 3) \text{ [Values can be obtained from step 1 table]}$$

$$D(B) = \min(2, 4) = 2$$

Therefore, currently the shortest path becomes 2.

Calculating shortest path from **A to C:**

$$D(C) = \min(D(C) , D(D) + \text{cost}(D, C))$$

$$D(C) = \min(5, 1 + 3)$$

$$D(C) = \min(5, 4) = 4$$

Therefore, currently the shortest path becomes 4.

Calculating shortest path from **A to E:**

$$D(E) = \min(D(E) , D(D) + \text{cost}(D, E))$$

$$D(E) = \min(\infty , 1 + 1)$$

$$D(E) = \min(\infty , 2) = 2$$

Therefore, currently the shortest path becomes 2.

Space for learners

We don't need to find the shortest path from **A** to **F** as there is no direct link to node **F** via node **D**, it will be ∞ .

N	D(B), P(B)	D(C), P(C)	D(D), P(D)	D(E), P(E)	D(F), P(F)
A	2, A	5, A	1, A	∞	∞
A,D	2, A	4, D	-	2, D	∞

STEP 3:

We can see in the above table from step 2 that node **B** and **E** both have the shortest paths. Let's take node **E** and it is added in **N**. Now, the shortest path to other nodes will be calculated through node **E**.

Calculating shortest path from **A to B**:

$$D(B) = \min(D(B), D(E) + \text{cost}(E, B))$$

$$D(B) = \min(2, 2 + \infty) \text{ [Values can be obtained from step 2 table]}$$

$$D(B) = \min(2, \infty) = 2$$

Therefore, currently the shortest path becomes 2.

Calculating shortest path from **A to C**:

$$D(C) = \min(D(C), D(E) + \text{cost}(E, C))$$

$$D(C) = \min(4, 2 + 1)$$

$$D(C) = \min(4, 3) = 3$$

Therefore, currently the shortest path becomes 3.

Calculating shortest path from **A to F**:

$$D(F) = \min(D(F), D(D) + \text{cost}(D, F))$$

$$D(F) = \min(\infty, 2 + 2)$$

$$D(F) = \min(\infty, 4) = 4$$

Therefore, currently the shortest path becomes 4.

N	D(B), P(B)	D(C), P(C)	D(D), P(D)	D(E), P(E)	D(F), P(F)
A	2, A	5, A	1, A	∞	∞
A,D	2, A	4, D		2, D	∞
A, D, E	2, A	3, E			4, E

STEP 4:

We can see in the above table from step 3 that node **B** has the shortest path. So, it is added in **N**. Now, the shortest path to other nodes will be calculated through node **B**.

Calculating shortest path from **A to C**:

$$D(C) = \min(D(C), D(B) + \text{cost}(B, C))$$

$$D(C) = \min(3, 2 + 3)$$

Space for learners

$$D(C) = \min(3, 5) = 3$$

Therefore, currently the shortest path becomes 3.

Calculating shortest path from **A to F**:

$$D(F) = \min(D(F), D(B) + \text{cost}(B, F))$$

$$D(F) = \min(4, 2 + \infty)$$

$$D(F) = \min(4, \infty) = 4$$

Therefore, currently the shortest path becomes 4.

N	D(B), P(B)	D(C), P(C)	D(D), P(D)	D(E), P(E)	D(F), P(F)
A	2, A	5, A	1, A	∞	∞
A,D	2, A	4, D		2, D	∞
A,D,E	2,A	3, E			4, E
A,D,E,B		3, E			4, E

STEP 5:

From step 4table we can see that node **C** has the shortest path. So, it is added in N. Now, the shortest path to other nodes will be calculated trough node **C**.

Calculating shortest path from **A to F**:

$$D(F) = \min(D(F), D(C) + \text{cost}(C, F))$$

$$D(F) = \min(4, 3 + 5)$$

$$D(F) = \min(4, 8) = 4$$

Therefore, currently the shortest path becomes 4.

N	D(B), P(B)	D(C), P(C)	D(D), P(D)	D(E), P(E)	D(F), P(F)
A	2, A	5, A	1, A	∞	∞
A,D	2, A	4, D		2, D	∞
A,D,E	2,A	3, E			4, E
A,D,E,B		3, E			4, E
A,D,E,B,C					4, E

STEP 6:

From step 4 table we can see that node **F** has the shortest path. So, it is added in N. The Final routing table is found having the shortest distances to all nodes from source **A**.

.N	D(B), P(B)	D(C), P(C)	D(D), P(D)	D(E), P(E)	D(F), P(F)
A	2, A	5, A	1, A	∞	∞
A,D	2, A	4, D		2, D	∞
A,D,E	2,A	3, E			4, E
A,D,E,B		3, E			4, E
A,D,E,B,C					4, E
A,D,E,B,C,F					

2.10 HIERARCHICAL ROUTING

Hierarchical routing is the arrangement of organizing the routers in a hierarchical way and based on hierarchical addressing. Here the network is divided into different regions or groups which are connected in a hierarchical fashion and a router from a particular region knows only about its own domain and other routers. So, the network can be viewed in two levels.

- The sub-network level.
- The network level.

In the sub-network level, each node in a region or domain has knowledge about the region's interface with other domains and its peers in the same domain. A region may have different local routing mechanism to handle traffic within the same region and send outgoing packets to the appropriate interface.

In the network level, each region can be considered as a single node connected to its interface nodes. The routing mechanisms at the network level handle the routing of packets between two interface nodes only, with no relation to intra-regional transfer.

Advantage of hierarchical routing is that the sizes of the routing tables are smaller which reduces the calculations in updating the tables. But the disadvantage of hierarchical routing is that once it is imposed on a network, it is followed and possibility of finding the direct paths is ignored, which may lead to sub optimal routing.

CHECK YOUR PROGRESS

11. Bellman Ford's algorithm is used by
 - a) Links State Routing
 - b) Distance Vector Routing
 - c) Flooding
 - d) None of these
12. Dijkstra's algorithm is used by
 - a) Links State Routing
 - b) Distance Vector Routing
 - c) Flooding
 - d) None of these
13. Which one of the followings is a level in hierarchical routing?
 - a) Data Link level
 - b) Sub-network level
 - c) Transport level
 - d) Application level
14. State TRUE or FALSE:
 - a) Flooding forwards the packets to all the links including the incoming one.
 - b) Routing tables are comparatively smaller in Hierarchical routing which enhances its performance.

Space for learners

2.11 UNICAST, BROADCAST AND MULTICAST ROUTING

In *unicast routing*, there is one source and one destination which is called one-to-one relationship. A unicast packet sent from one source passes through routers to reach its destination. The routers forward the received unicast packets through only one of its interfaces.

In *multicast routing*, there is only one source and multiple numbers of destinations which is called one-to-many relationship. Here, the source address is a unicast address but the destination address is a group of addresses defining one or more destinations. A multicast packet sent from the source node goes to all destinations belonging to a group. The routers may forward the multicast packets through several of its available interface.

In *broadcast routing*, the source transmits the packet to all the nodes as destinations even if they don't want it. The relationship between the source and destination is called one-to-all. Broadcasting is not usually supported as it creates a huge amount of traffic.

2.12 QUEUING THEORY

Queuing theory is the study of formation, function and congestion of queues or waiting lines with the help of mathematics. A model is constructed for predicting the queue length and waiting time and is known as a queuing model.

A queuing situation involves two parts.

1. Someone or something that requests for a service which is usually referred to as a customer or job or request.
2. Someone or something that completes or delivers the services and is usually referred to as server.

Queuing theory inspects the whole system of waiting in line, including elements like the customer arrival rate, number of servers and customers, waiting area capacity, average service completion time and queuing discipline. Queuing discipline refers to the rules of formation of the queue, for example whether the queue is being formed based on a principle of first-in-first-out, last-in-first-out, prioritized or serve-in-random-order.

Space for learners

Applications of queuing theory includes management of single-server queues, retrial/balking queues, finite-buffer queues, multiple queues and optimization in queues as well. Queuing theory is also applied in performance analysis, various network model constructions and in performance enhancement of routing algorithms.

Space for learners

CHECK YOUR PROGRESS

15. Multicast routing is
- a) One-to-one relationship
 - b) many-to-one relationship
 - c) One-to-many relationship
 - d) Many-to-many relationship
16. If there is one source and one destination then it is
- a) Unicasting b) Multicasting
 - c) Broadcasting d) Supercasting
17. Mathematical study of queues or waiting lines is known as?
- a) Waiting Theory b) Relaxing Theory
 - c) Queen Theory d) Queuing theory
18. **State TRUE or FALSE:**
- a) In broadcast routing, source transmits the packet to all the nodes as destinations even if they don't want it.
 - b) In Queuing theory, someone that completes or delivers the services is usually referred to as server.
 - c) In Multicast routing, a router forwards the packets only via one interface.

2.13 SUMMING UP

- The network layer is responsible for the delivery of individual packets from source to destination host.
- Routing is one of the services provided by the network layer. Routing involves the delivery of packets or datagrams between end systems situated on different networks

- When congestion occurs in a network the throughput of the network decreases along with the response time.
- Adaptive routing algorithms change their routing decisions and also known as dynamic routing algorithms whereas static algorithms or Non-adaptive routing algorithms don't change their decisions.
- The goal of routing is to find and transmit through the optimal path.
- Dijkstra's Algorithm, Bellman Ford's Algorithm, Floyd Warshall's Algorithms are examples of some shortest path routing algorithms
- Some other dynamic routing algorithms are link state routing and distance vector routing.
- Queuing theory is the study of formation, function and congestion of queues or waiting lines with the help of mathematics. It helps in optimization in network models.

Space for learners

2.14 ANSWERS TO CHECK YOUR PROGRESS

1. (b), 2 (d), 3 (c), 4.a True, 4.b False, 4.c False, 5. (b), 6. (c), 7.a False, 7.b False, 7.c True 8. (a), 9. (b), 10.a False, 10.b False, 10.c True, 11. (b), 12. (a), 13. (b), 14.a False, 14.b True, 15. (c), 16. (a), 17. (d), 18.a True, 18.b True, 18.c False.

2.15 POSSIBLE QUESTIONS

Short answer type questions:

- What is need of routing? Explain.
- What do you mean by congestion in a network?
- What are the two types of routing algorithms?
- What do you mean by adaptive routing algorithms?
- What do you mean by non-adaptive routing algorithms?
- Give one examples of each adaptive routing algorithms and non-adaptive routing algorithms.
- What do you mean by flooding?
- What do you mean by random walk?
- What is a routing table?

- What do you mean by a distance vector?
- What do you mean by hierarchical routing?
- Explain the terms unicast, multicast and broadcast routing?
- What do you mean by queuing theory?

Long answer type questions:

- Explain the Dijkstra's algorithm to find a single source shortest path in a network.
- Explain the Bellman Ford's algorithm with an example.
- Explain the Floyd Warshall's algorithm with an example.
- Explain the Distance Vector Routing in details with a suitable example.
- Explain the working of Link State Routing in details with a suitable example.
- What is flooding? Explain various types of flooding techniques available.

2.16 REFERENCES AND SUGGESTED READINGS

- Behrouz A Forouzan, *Data Communications and Networking*, The McGraw-Hill Companies, Latest edition.

Space for learners

UNIT 3: THE NETWORK LAYER: THE INTERNET

Space for learners

Unit Structure:

- 3.1 Introduction
- 3.2 Unit Objectives
- 3.3 Introduction to Network Layer
- 3.4 Network Layer Design Issues
 - 3.4.1 Store-and-Forward Switching
 - 3.4.2 Services provided to the Transport Layer
 - 3.4.3 Implementation of Connectionless Services
 - 3.4.4 Implementation of Connection Oriented Services
- 3.5 Switching Techniques
 - 3.5.1 Circuit Switching
 - 3.5.2 Message Switching
 - 3.5.3 Packet Switching
- 3.6. Approaches in Packet Switching
 - 3.6.1 Virtual Circuit
 - 3.6.2 Datagram Subnets
 - 3.6.3 Comparison between VC and Datagram
- 3.7 Summing Up
- 3.8 Answers to Check Your Progress
- 3.9 Possible Questions
- 3.10 References and Suggested Readings

3.1 INTRODUCTION

In this unit, you will learn about the different design issues in network layer. You will be introduced to the connection oriented and connection less services of network layer. Switching techniques will also be explained in detailed in this unit. You will also learn about the approaches of packet switching techniques.

3.2 UNIT OBJECTIVES

After going through this unit, you will be able to:

- Distinguish between connection-oriented and connectionless services.

- Understand the nature of network services and use network primitives to describe network service scenarios.
- Describe how circuit switching works and appreciate its strengths and weaknesses.
- Describe how packet switching works and distinguish between the virtual circuit and datagram methods and their packet formats.

Space for learners

3.3 INTRODUCTION TO NETWORK LAYER

Network-to-network connections are what make the Internet possible. The "network layer" is the part of the Internet communications process where these connections occur, by sending packets of data back and forth between different networks. The network layer provides routing and related functions that enable multiple data links to be combined into an internetwork. This is accomplished by the logical addressing of devices. The network layer supports both connection-oriented and connectionless service from higher layer protocols. The Network layer routes data using

- Switching,
- Network layer addressing and
- Routing protocol.

The main objective of this layer is to control the operation of the subnet. It is the layer, which provides Internet Protocol (IP) to use it. It is mainly responsible for providing routing services from source to destination across the Internet. In doing so, it allows internetworking among heterogeneous networks using different addressing, length of packet, protocols, etc. The routing may be static or dynamic. Network layer also plays important role in congestion control. It also shields the above layers from details about the underlying network and the routing technology that might have been deployed to connect different networks together. In addition to routing, this layer is responsible for establishing and maintaining the connection. In broadcast networks, the routing problem is simple, so the network layer is often thin or even nonexistent.

Network Layer processes and methods are applicable for the following reasons:

- Logically separate networks must have unique network addresses.
- Switching determines how to make connections throughout the internetwork
- Implementation of router and to identify best data path through internetwork
- Implementing different levels of connection services, depending on the number of errors expected in the internetwork

3.4 NETWORK LAYER DESIGN ISSUES

The network layer or layer 3 of the OSI (Open Systems Interconnection) model is concerned delivery of data packets from the source to the destination across multiple hops or links. It is the lowest layer that is concerned with end-to-end transmission. The designers who are concerned with designing this layer needs to cater to certain issues. These issues encompass the services provided to the upper layers as well as internal design of the layer.

The design issues can be elaborated under four heads –

- Store-and-Forward Switching
- Services to Transport Layer
- Providing Connection Oriented Service
- Providing Connectionless Service

3.4.1 Store-and-Forward Switching

The network layer operates in an environment that uses store and forward packet switching. The node which has a packet to send, delivers it to the nearest router. The packet is stored in the router until it has fully arrived and its checksum is verified for error detection. Once, this is done, the packet is forwarded to the next router. Since, each router needs to store the entire packet before it can forward it to the next hop, the mechanism is called store-and-

Space for learners

forward switching. Figure 3.1 presents a schematic view of store-and-forward switching issue.

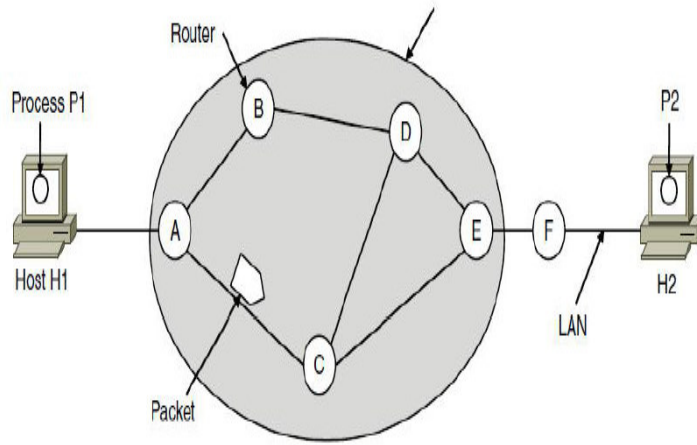

Figure 3.1: Store-and-forward switching concept

3.4.2 Services Provided to the Transport Layer

The network layer provides service to its immediate upper layer, namely transport layer, through the network–transport layer interface. The two types of services provided are:

- Connection Oriented Service – In this service, a path is setup between the source and the destination, and all the data packets belonging to a message are routed along this path.
- Connectionless Service – In this service, each packet of the message is considered as an independent entity and is individually routed from the source to the destination.

The objectives of the network layer while providing these services are:

- The services should not be dependent upon the router technology.
- The router configuration details should not be of a concern to the transport layer.
- A uniform addressing plan should be made available to the transport layer, whether the network is a LAN, MAN or WAN.

Space for learners

3.4.3 Implementation of Connectionless Service

In connectionless service, since each packet is transmitted independently, each packet contains its routing information and is termed as datagram. The network using datagrams for transmission is called datagram networks or datagram subnets. No prior setup of routes is needed before transmitting a message. Each datagram belong to the message follows its own individual route from the source to the destination. An example of connectionless service is Internet Protocol or IP.

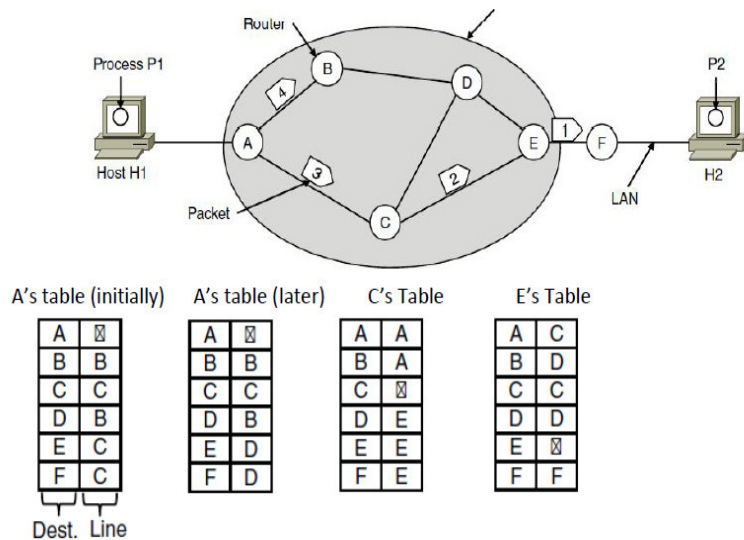

A's table (initially)	A's table (later)	C's Table	E's Table
A B	A B	A A	A C
B B	B B	B A	B D
C C	C C	C B	C C
D B	D B	D E	D D
E C	E D	E E	E B
F C	F D	F E	F F

Figure 3.2: A connectionless service

Let us assume an example that the message is four times longer than the maximum packet size, so the network layer has to break it into four packets, 1, 2, 3, and 4, and send each of them in turn to router A as shown in figure 3.2.

Every router has an internal table telling it where to send packets for each of the possible destinations. Each table entry is a pair (destination and the outgoing line). Only directly connected lines can be used.

A's initial routing table is shown in the figure under the label "initially".

At A, packets 1, 2, and 3 are stored briefly, having arrived on the incoming link. Then each packet is forwarded according to A's table, onto the outgoing link to C within a new frame.

Space for learners

Packet 1 is then forwarded to E and then to F.

However, something different happens to packet 4. When it gets to A it is sent to router B, even though it is also destined for F. For some reason (traffic jam along ACE path), A decided to send packet 4 via a different route than that of the first three packets. Router A updated its routing table, as shown under the label “later”.

The algorithm that manages the tables and makes the routing decisions is called the routing algorithm.

3.4.4 Implementation of Connection-Oriented Service

In connection-oriented service, a path or route called a virtual circuit is setup between the source and the destination nodes before the transmission starts. All the packets in the message are sent along this route. Each packet contains an identifier that denotes the virtual circuit to which it belongs to. When all the packets are transmitted, the virtual circuit is terminated and the connection is released. An example of connection-oriented service is Multi-Protocol Label Switching (MPLS).

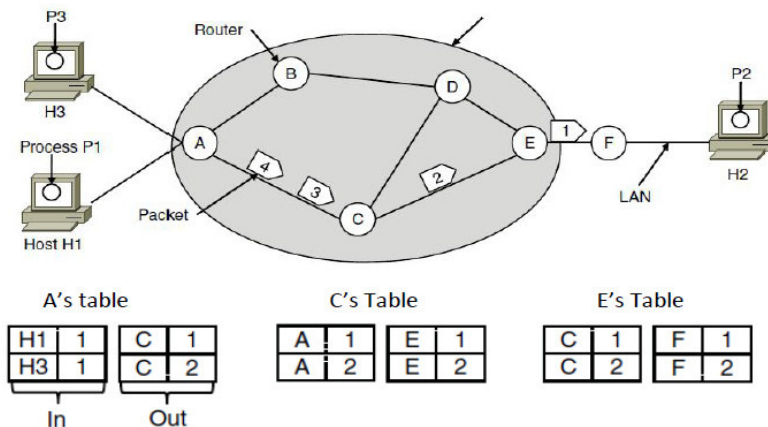

Figure 3.3: A Connection-Oriented Service

As an example, consider the situation shown in Figure 3.3. Here, host H1 has established connection 1 with host H2. This connection is remembered as the first entry in each of the routing tables. The first line of A's table says that if a packet bearing connection identifier 1 comes in from H1, it is to be sent to router C and given

connection identifier 1. Similarly, the first entry at C routes the packet to E, also with connection identifier 1.

Now let us consider what happens if H3 also wants to establish a connection to H2. It chooses connection identifier 1 (because it is initiating the connection and this is its only connection) and tells the network to establish the virtual circuit.

This leads to the second row in the tables. Note that we have a conflict here because although *A* can easily distinguish connection 1, packets from *H1* from connection 1 packets from *H3*, *C* cannot do this. For this reason, *A* assigns a different connection identifier to the outgoing traffic for the second connection. Avoiding conflicts of this kind is why routers need the ability to replace connection identifiers in outgoing packets

3.5 SWITCHING TECHNIQUES

The generic method for establishing a path for point-to-point communication in a network is called switching. In large networks, there can be multiple paths from sender to receiver. The switching technique will decide the best route for data transmission. Switching technique is used to connect the systems for making one-to-one communication. This subsection discusses the following data switching techniques:

- Circuit switching
- Message Switching
- Packet Switching

3.5.1 Circuit Switching

Circuit switching is a technique that connects the sender and the receiver by a single path for the duration of conversation. After a connection is established, a dedicated path exists between both ends. For example, telephone switching equipment uses numbers to establish a path that connects the sender's and receiver's telephone. Circuit switching in a computer network operates in the same way. The computer initiating the transfer asks for a connection to the destination. After the connection is made, the destination device

Space for learners

acknowledges that it is ready to carry on a transfer. Communication through circuit switching has three phases.

- Circuit establishment
- Data transfer
- Circuit Disconnect

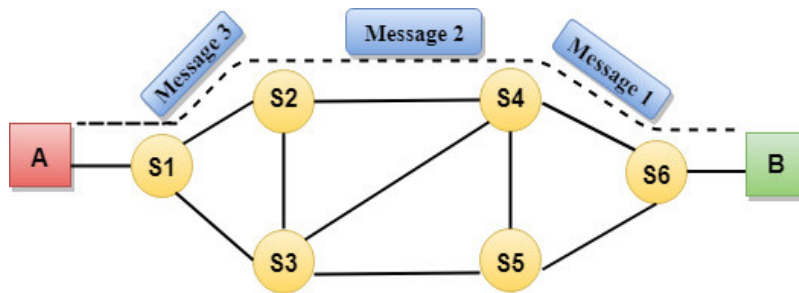

The following table shows circuit switching benefits and considerations.

Benefits	Considerations
Dedicated transmission channel with guaranteed data rate.	Single, dedicated channel makes inefficient use of media.
Virtually no channel access delay after circuit is established.	Dedicated channels are relatively expensive. Subject to long connection delays.

3.5.2 Message Switching

Message switching does not establish a dedicated path between two workstations for an entire conversation. Rather, conversations are divided into messages. Each message is packaged with its own destination address and then transmitted from device to device through the network. A message switching device is typically a general purpose computer. It needs sufficient storage capacity to temporarily store incoming messages, which can be quite long. This type of scheme introduces a delay due to the time required both to find the next stop in the transmission path and to save the retransmit message.

Space for learners

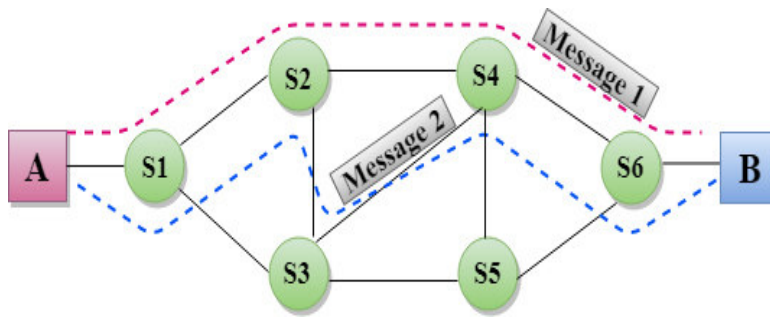

The following table shows message switching benefits and considerations.

Benefits	Consideration
More devices can share network bandwidth than with circuit switching	Not compatible with most real time applications such as audio or video communications Often costly- must have large storage devices to hold potentially long messages.
Temporary messages storage can reduce traffic congestion	
Low priority messages can be delayed so that higher priority messages can be forwarded first.	
One message can be sent to many destinations through broadcast addresses	
Global communications are improved because receiver need not be present when message is sent	

3.5.3 Packet Switching

The packet switching is a switching technique in which the message is sent in one go, but it is divided into smaller pieces, and they are sent individually. The message splits into smaller pieces known as packets and packets are given a unique number to identify their order at the receiving end. Every packet contains some information in its headers such as source address, destination address and sequence number. Packets will travel across the network, taking the shortest path as possible. All the packets are reassembled at the receiving end in correct order. If any packet is missing or corrupted,

Space for learners

then the message will be sent to resend the message. If the correct order of the packets is reached, then the acknowledgment message will be sent.

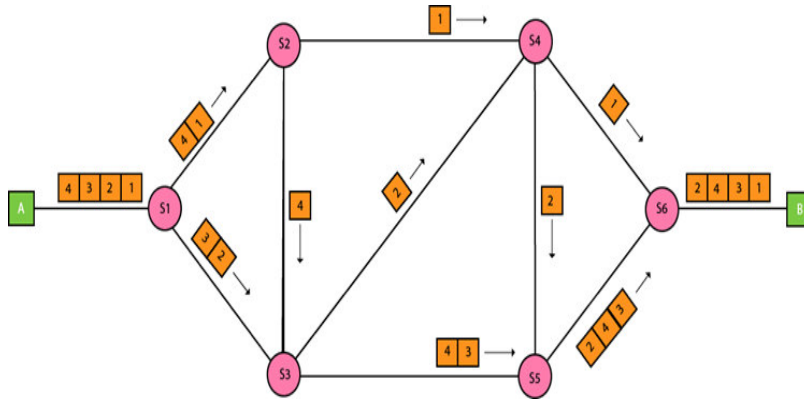

The following table shows packet switching benefits and considerations.

Benefits	Consideration
Cost effective, because devices do not need massive amounts of storage	Protocols are typically more complex and can increase implementation costs. Packets are more easily lost, requiring retransmission.
Less transmission delay	
Packets can be routed around problem links	
Optimal use of link bandwidth	

3.6 APPROCHES IN PACKET SWITCHING

There are two approaches in packet switching.

- Virtual Circuits
- Datagram subnets

3.6.1 Virtual Circuits

Virtual circuits are logical connections between sender and receiver. A logical connection is formed when sender and receiver exchange messages at the outset of a conversation.

Space for learners

The messages allow sender and receiver to agree on conversations, parameters such as maximum messages size, path to be taken and other variables to establish and maintain the conversation.

Virtual circuits usually imply connection oriented connection services. Virtual circuits can be temporary (lasting through one conversation) or permanent (lasting as long as the sending and receiving computers are operating). Virtual circuits are costly to implement. Figure 3.4 presents a virtual circuit model.

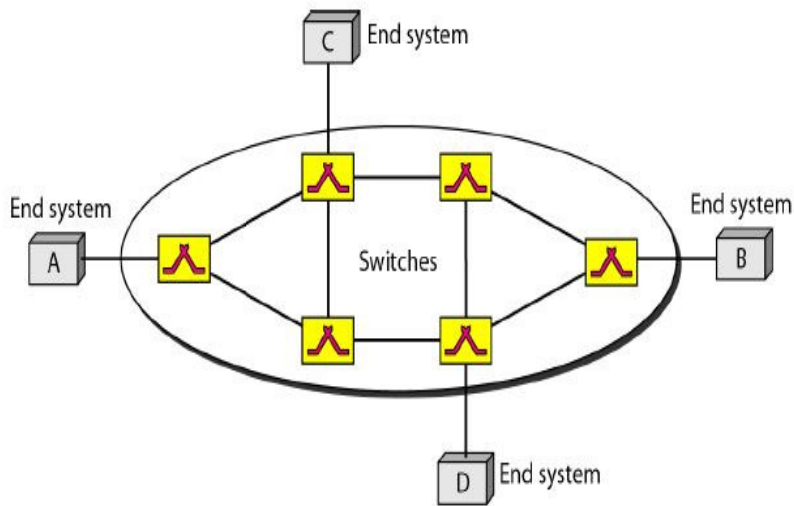

Figure 3.4: Virtual Circuit Model

Advantages of Virtual Circuit:

1. Packets are delivered to the receiver in the same order sent by the sender.
2. Virtual circuit is a reliable network circuit.
3. There is no need for overhead in each packet.
4. Single global packet overhead is used in virtual circuit.

Disadvantages of Virtual Circuit:

1. Virtual circuit is costly to implement.
2. It provides only connection-oriented service.
3. Always a new connection set up is required for transmission.

Space for learners

3.6.2 Datagram Subnets

It is connectionless service. There is no need of reservation of resources as there is no dedicated path for a connection session. All packets are free to move to any path on any intermediate router which is decided on the go by dynamically changing routing tables on routers. Since every packet is free to choose any path, all packets must be associated with a header with proper information about source and the upper layer data. The connectionless property makes data packets reach destination in any order, means they need not reach in the order in which they were sent. Datagram networks are not reliable as Virtual Circuits. But it is always easy and cost efficient to implement datagram networks as there is no extra headache of reserving resources and making a dedicated each time an application has to communicate.

3.6.3 Comparison Between Virtual Circuit and Datagram

The following table shows the comparison between virtual circuits and datagram networks.

Parameter	Virtual Circuit	Datagram
Connection Setup	Required	None
Addressing	Packet contains short virtual circuit number identifier.	Packet contains full source and destination address
State Information	Each virtual circuit number entered to table on setup, used for routing.	None other than router table containing destination network
Routing	Route established at setup, all packets follow same route.	Packets routed independently
Effects of Router Failure	All virtual circuits passing through failed router terminated.	Only on packets lost during crash
Congestion	Simple by pre-	Difficult since all

Space for learners

Control	allocating enough buffers to each virtual circuit at setup, since maximum number of circuits fixed	packets routed independently router resource requirements can vary.
---------	--	---

Space for learners

CHECK YOUR PROGRESS - I

1. Write the functions of network layer?
2. Explain store and forward Switching?
3. What are the advantages and disadvantages of virtual circuit?

State TRUE or FALSE:

1. Telephone network is an example of packet switching network.
2. It is the network layer responsibility to forward packets reliability from the source to destination.
3. Virtual circuit is easy to implement.
4. Datagram networks are not reliable as Virtual Circuits.
5. Packet switching has high transmission delay.

3.7 SUMMING UP

- The ability of transmitting messages from one end to another is called internetworking.
- The network layer provides routing and related functions that enable multiple data links to be combined into an internetwork.
- The Network layer routes data using switching, network layer addressing and routing protocol.
- Circuit switching is a technique that connects the sender and the receiver by a single path for the duration of conversation.

- Message switching does not establish a dedicated path between two workstations for an entire conversation. Rather, conversations are divided into messages
- The packet switching is a switching technique in which the message is sent in one go, but it is divided into smaller pieces, and they are sent individually.
- Virtual circuits are logical connections between sender and receiver.
- In a connectionless service, the user simply bundles the information collectively and adds the destination address on it to then send it to the specified destination
- In a connection-oriented service, the user must pay for the length of the connection.

Space for learners

3.8 ANSWERS TO CHECK YOUR PROGRESS

- 1 In connection-oriented service, each packet is associated with a source/destination connection. These packets are routed along the same path, known as a virtual circuit.
- 2 In a connectionless service, a router treats each packet individually. The packets are routed along different paths through the network according to the decisions made by the routers.
- 3 Switching is the generic method for establishing a path for point-to-point communication in a network.
- 4 The **datagram** method (also known as **connectionless**) does not rely on a pre-established route; instead, each packet is treated independently.

3.9 POSSIBLE QUESTIONS

Short answer type questions:

1. How network layer routes data?
2. What is the purpose of internetworking?
3. What are the responsibilities of network layer?

4. Name the two services provided to transport layer by network layer?
5. What are the different switching techniques?

Long answer type questions:

6. Explain the implementation of connectionless services with an example?
7. Write the advantages and disadvantages of Circuit switching and message switching techniques?
8. What are the approaches in implementing packet switching? Explain
9. Write the comparison between Virtual Circuit and Datagram subnets.
10. Differentiate between connection oriented and connectionless services.

3.10 REFERENCES AND SUGGESTED READINGS

- [1] Andrew S. Tanenbaum, Computer Networks, Prentice Hall
- [2] Behrouz A. Forouzan, Sophia Chung Fegan, Data Communications and Networking, McGraw-Hill Companies
- [3] Burton, Bill, Remote Access for Cisco Networks, McGraw-Hill Osborne Media
- [4] Rajneesh Agrawal and Bharat Bhushan Tiwari, Data Communication and Computer Networks, Vikas Publishing House, New Delhi

Space for learners

UNIT 4: THE TRANSPORT LAYER: THE SERVICES

Space for learners

Unit Structure:

- 4.1 Introduction
- 4.2 Unit Objectives
- 4.3 Services for upper layer
- 4.5 Type of Service
 - 4.5.1 End-to-end delivery
 - 4.5.2 Addressing
 - 4.5.3 Segmentation and Reassembly
 - 4.5.4 Connection Control
 - 4.5.5 Multiplexing
 - 4.5.6 Flow Control
 - 4.5.7 Error Control
- 4.6 Quality of Service
 - 4.6.1 Requirements
 - 4.6.2 Techniques for Achieving Good QOS
- 4.7 Data Transfer
 - 4.7.1 Error Control
 - 4.7.2 Sequence Control
 - 4.7.3 Loss Control
 - 4.7.4 Duplication Control
- 4.8 Connection Management
 - 4.8.1 Connection Establishment
 - 4.8.2 Connection Release
- 4.9 Transmission Control Mechanism
 - 4.9.1 User Datagram Protocol
 - 4.9.2 Transmission Control Protocol
- 4.10 Flow Control
- 4.11 Summing Up
- 4.12 Answers to Check Your Progress
- 4.13 Possible Questions
- 4.14 Further Readings

4.1 INTRODUCTION

The transport layer is the 4th layer in OSI network model. The fundamental function of this layer is to provide a logical communication between application processes running on different hosts. In this unit, you will learn the delivery of an entire message from an application program on the source device to a similar application program on the destination device. You will learn the all modules and procedures pertaining to transportation of data or data stream. You also learn about the categorization of all modules and procedure needed for the transportation of data in this layer. This layer gives the idea about the peer-to-peer and end-to-end connection between two processes on remote hosts. Transport layer takes data from upper layer (i.e. Application layer) and then breaks it into smaller size segments, numbers each byte, and hands over to lower layer (Network Layer) for delivery. This layer ensures that the data must be received in the same sequence in which it was sent. You will get the idea of two main Transport layer protocols: Transmission Control Protocol and User Datagram Protocol. Further, you will be able to learn about the different types of transport service primitives, quality of services, connection management, transport control mechanism, flow control.

4.2 UNIT OBJECTIVES

After going through this unit, you will able to:

- Understand the services provided by the transport layer to the session layer.
- Know peer-to-peer and end-to-end connection.
- Know the different types of transport service primitives.
- Get the concept of the connection establishment between processes on remote machine.
- Learn transmission control protocol and user datagram protocol.
- Understand flow control.

Space for learners

4.3 SERVICES FOR UPPER LAYER

The main objective of the transport layer is to provide efficient, reliable and cost-effective services to its users generally processes in the application layer. The main role of the transport layer is to provide the communication services directly to the application processes running on different hosts.

The basic function of the Transport layer is to accept data from the layer above, split it up into smaller units, pass these data units to the Network layer. This layer ensures that all the pieces arrive correctly at the other end. Transport layer works transparently within the layers to deliver and receive data without errors. The sender side breaks application messages into segments (packets) and passes them on to the network layer. The receiving side then reassembles segments into messages and passes them to the application layer. All these must be done efficiently in a way that isolates the upper layers from the inevitable changes in the hardware technology. The Transport layer also determines what type of service to provide to the Session layer, and ultimately to the users of the network. The most popular type of transport connection is an error-free point-to-point channel that delivers messages or bytes in the order in which they were sent.

4.4 TRANSPORT SERVICE PRIMITIVES

A Service is specified by set of primitives. These services are used by user or other various entities to access the service. All these primitives simply tell the service to perform some action or to report on action that is taken by peer entity.

The transport layer must provide some operations to application programs, that is, a transport service interface. These interfaces allow users to access the transport service. Each transport service has its own interface.

The network service is intended to model the service offered by real networks. Real networks can lose packets, so the network service is generally unreliable. The (connection-oriented) transport service, in contrast, is reliable. Real networks are not error-free, but that is precisely the purpose of the transport layer to provide a reliable service on unreliable network.

Space for learners

The primitives for simple transport service are-

1. LISTEN: When the server is ready to accept request of incoming connection, it simply puts this primitive into action. LISTEN primitive simply waits for incoming connection request.
2. CONNECT: This primitive is used to connect the server by creating or establishing connection with waiting peer.
3. SEND: SEND primitive is put into action by the client to transmit its request that is followed by receive primitive. This primitive sends or transfers the message to the peer.
4. RECEIVE: This primitive block the server. RECEIVE primitive waits for a DATA packet to arrive.
5. DISCONNECT: This primitive is used to terminate the connection after which no sender will be able to send any message.

The TPDU (Transport Protocol Data Unit) is used for messages sent from transport entity to transport entity. The TPDUs is exchanged by the transport layer and contained in Packets exchanged by the network layer. And packets are contained in

Frames. The nesting of TPDU, Packet and Frame is presented in figure 4.1.

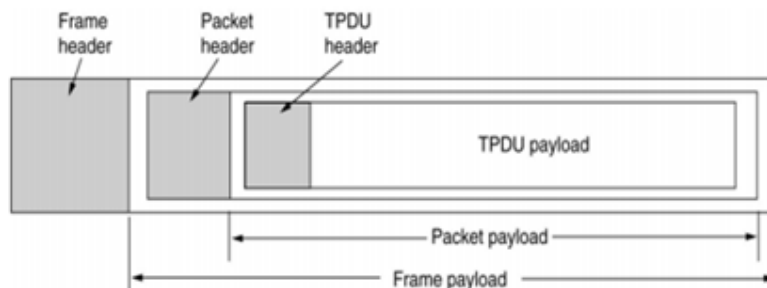

Figure 4.1: The nesting of TPDU, Packet and Frame

When a client wishes to talk to the server it issues a CONNECT primitive. Transport entity now blocks the client and sends a packet to the server CONNECTION REQ containing a transport layer message for the server's transport layer. When the CONNECTION REQ arrives at the server, the server's transport entity checks to see if the server is blocked on a LISTEN and can therefore handle server requests. Server is unblocked and a CONNECTION

Space for learners

ACCEPTED TPDU is sent back to the client. This unblocks the client and the connection is established.

Data is exchanged using SEND and RECEIVE primitives. When the TPDU arrives, the receiver is unblocked. Then the receiver processes the TPDU and send a reply. When a connection is no longer required, it must be released to free up table space within the two transport entities.

A state diagram for a simple connection management scheme is

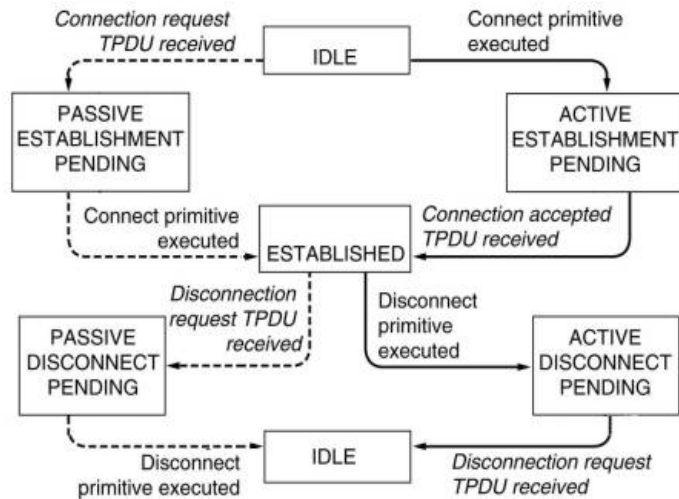

Figure 4.2: State Diagram of Simple Connection Management Scheme

shown in figure 4.2. Transitions labelled in italics are caused by packet arrivals. The solid lines show the client's state sequence. The dashed lines show the server's state sequence.

CHECK YOUR PROGRESS

1. Transport layer is the _____th layer of OSI Model.
2. The _____ is responsible for end-to-end delivery, segmentation, and concatenation.
3. Transport layer aggregates data from different applications into a single data unit before passing it to _____.
4. The message sent from transport entity to transport entity is called as _____.
5. State true or False
 - a. RECEIVE primitive waits for a DATA packet to

Space for learners

- arrive.
- b. Each transport service has its own interface.
 - c. Client issues a SEND primitive when it wants to talk to the server.

Space for learners

4.5 TYPES OF SERVICE

The services provided by the transport layer are similar to those of the data link layer. The data link layer provides the services within a single network while the transport layer provides the services across an internetwork made up of many networks. The data link layer controls the physical layer and the transport layer controls all the lower layers. The services provided by the transport layer protocol are

4.5.1 End-To-End Delivery

The transport layer transmits the entire message to the destination. Therefore, it ensures the end-to-end delivery of an entire message from a source to the destination.

4.5.2 Addressing

The system can run various programs at the equivalent time. For this reason, the header must contain a type of address known as service point address or port. The port variable represents a particular TS user of a specified station known as a Transport Service access point (TSAP). Each station has only one transport entity. The transport layer protocols need to know which upper-layer protocols are communicating. The transport layer receives the entire message to restore the process on that computer.

4.5.3 Segmentation and Reassembly

The message is split into several packets. Each packet has its sequence number. The transport layer reassembles the message correctly according to the order number and identifies the lost message.

4.5.4 Connection Control

This layer can be connection-oriented or connectionless. The connectionless transport layer treats each packet as independent and produces it to the destination. But, the connection-oriented transport layer first makes the connection and then provides the respective data.

4.5.5 Multiplexing

The transport layer uses the multiplexing to improve transmission efficiency. Multiplexing can occur in two ways.

4.5.5.1 Upward Multiplexing

Upward multiplexing means multiple transport layer connections use the same network connection. To make more cost-effective, the transport layer sends several transmissions bound for the same destination along the same path; this is achieved through upward multiplexing.

4.5.5.2 Downward Multiplexing

Downward multiplexing means one transport layer connection uses the multiple network connections. Downward multiplexing allows the transport layer to split a connection among several paths to improve the throughput. This type of multiplexing is used when networks have a low or slow capacity.

4.5.6 Flow Control

It is also responsible for flow control implementing end to end delivery instead of across an individual link. Flow control is used to prevent the sender from overwhelming the receiver. If the receiver is overloaded with too much data, then the receiver discards the packets and asking for the retransmission of packets. It uses the sliding window protocol that makes the data transmission more efficient as well as it controls the flow of data so that the receiver does not become overwhelmed.

Space for learners

4.5.7 Error Control

The transport layer can support error control. The error control at the transport layer is implemented end to end instead of across an individual link. Error correction is frequently completed by retransmission. Therefore, the transport layer performs the checking for the errors end-to-end to ensure that the packet has arrived correctly.

STOP TO CONSIDER

When the size of the data units received from the upper layer is too long to handle, the transport layer divides it into smaller usable blocks. This dividing process is called segmentation.

When the sizes of the data units belonging to a single session are so small that the several data unit can fit together into a single data unit, the transport protocol combines them into a single data unit. This combining process is called concatenation.

4.6 QUALITY OF SERVICE

Quality of service (QOS) is the measurement of the overall performance of a service particularly the performance seen by the users of the network. It is particularly important for the transport of traffic with special requirements. For achieving the quality of service, it is indeed imperative to maintain the traffic at different nodes in the network.

4.6.1 Requirements

The QOS parameters can be negotiated during connection establishment. The requirements of each flow can be characterized by some parameter. These parameters jointly determine the QOS that the flow requires. The transport layer's quality of services are discussed in the following:

4.6.1.1 Connection Establishment Delay

Source-to-destination delay is a flow characteristic. In this case, telephony, audio conferencing, video conferencing, and remote

Space for learners

login basically need a minimum delay, while delay in file transfer or e-mail is less important.

The time difference mainly between the instant at which a transport connection is requested and the instant at which it is confirmed is called connection establishment delay. The shorter the delay is the better the QOS.

4.6.1.2 Connection Establishment Failure Probability

It is the probability that a connection is not established even after the maximum connection establishment delay. This can be due to network congestion, lack of table space, or some other problems.

4.6.1.3 Throughput

It mainly measures the number of bytes of user data transferred per second, measured over some time interval. It is measured separately for each direction.

Different applications need different bandwidths. In video conferencing, we need to send millions of bits per second to refresh a color screen while the total number of bits in an e-mail may not reach even a million.

4.6.1.4 Transit Delay

It is the time between a message being sent by the transport user on the source machine and its being received by the transport user in the destination machine.

4.6.1.5 Residual Error Ratio

It measures the number of lost or distorted messages as a fraction of the total messages sent. Ideally, the value of this ratio should be zero and practically it should be as small as possible.

4.6.1.6 Priority

This parameter provides a way for the user to show that some of its connections are more important (have higher priority) than the other ones. This is important while handling congestion. Because the

Space for learners

higher priority connections should get service before the low priority connections.

4.6.1.7 Resilience

Due to internal problems or congestion, the transport layer spontaneously terminates a connection. The resilience parameter gives the probability of such a termination.

4.6.1.8 Reliability

Lack of reliability means losing a packet or acknowledgment which entails retransmission. However, the sensitivity of any application programs to reliability is not the same. For example, file transfer and email service require reliable service unlike telephone or audio conferencing.

4.6.1.9 Jitter

Jitter is the variation in delay for packets associated with the same flow. For applications such as audio and video applications, it does not matter if the packets arrive with a short or long delay as long as the delay is the same for all packets. High jitter means the difference between delays is large, low jitter means the variation is small.

4.6.2 Techniques for Achieving Good QoS

Now, we will discuss some of the techniques that can play important role to reduce the effect of congestion at any node of a networking device, and thus improving the QoS.

4.6.2.1 Over Provisioning

It is an easy technique. It provides so much router capacity, buffer space and bandwidth that the packets can move through easily.

4.6.2.2 Buffering

The receiving side can buffer the packets before being delivered. Buffering increases the delay and smoothen out the jitter without affecting the reliability or bandwidth.

Space for learners

4.6.2.3 Packet Scheduling

Packets from different flows arrive at a switch or router for Processing. A good scheduling technique treats the different flows in a fair and appropriate manner. Some scheduling techniques to improve the quality of service are

1. FIFO Queuing

In FIFO Queuing, packets wait in a Queue until the node is ready to process them. If the average rate is higher than the average processing rate, the queue will fill up and new packets will be discarded.

2. Priority Queuing

In this queuing, packets are first assigned to **priority class**. Each priority class has its own Queue. The packets in the highest priority Queue are processed first. But if there is a continuous flow in high-priority Queue, the packets in the low priority Queues will never have a chance to be processes.

3. Weighted Fair Queuing

In this method, the packets are still assigned to different classes and admitted to different queues. The queues are weighted based on the priority of the queues. The higher priority means a higher weight. The system processes packets in each queue in a round-robin fashion with the number of packets selected from each queue based on the corresponding weight.

For example: If the weights are 3, 2 and 1, three packets are processed from the first queue, two from the second queue and one from the third queue. If the system does not impose priority on the classes, all weights can be equal.

4.6.2.4 Leaky Bucket

This technique is used for traffic shaping to control the amount and the rate of the traffic sent to the network. This is implemented using a buffer at the interface level. If a bucket has a small hole at the bottom, the water leaks from the bucket at a constant rate as long as there is water in the bucket. The rate at which the water leaks does not depend on the rate at which the water is input to the bucket

Space for learners

unless the bucket is empty. Buffer stores the data and forwards it in regular 'T' intervals.

The input rate can vary, but the output rate remains constant. Similarly, in networking, a technique called leaky bucket can smooth out bursty traffic. Bursty chunks are stored in the bucket and sent out at an average rate. A leaky bucket is shown in figure 4.3.

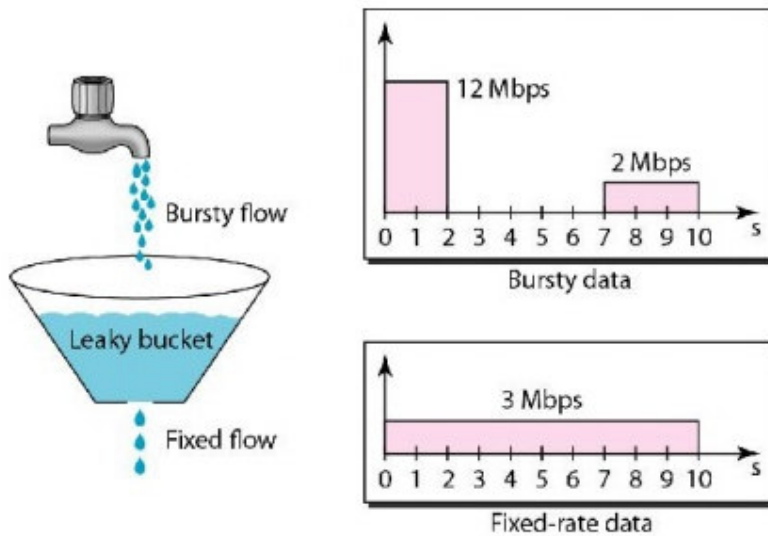

Figure 4.3: Leaky Bucket

A leaky bucket algorithm shapes bursty traffic into fixed-rate traffic by averaging the data rate. It may drop the packets if the bucket is full.

4.6.2.5 Token Bucket

The leaky bucket is very restrictive. It does not credit an idle host. The time when the host was idle is not taken into account.

The token bucket is another traffic shaping technique that allows idle hosts to accumulate credit for the future in the form of tokens. For each tick of the clock, the system sends n tokens to the bucket. The system removes one token for every cell (or byte) of data sent. For example, if n is 100 and the host is idle for 100 ticks, the bucket collects 10,000 tokens.

Space for learners

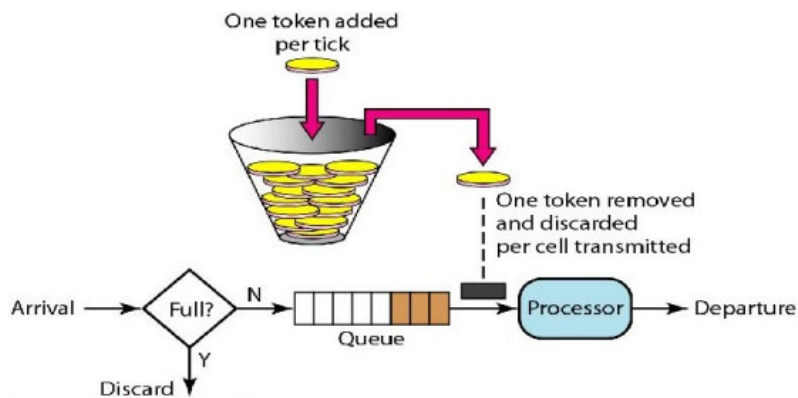

Figure 4.4: Token Bucket

The token bucket as depicted in figure 4.4 can easily be implemented with a counter. The token is initialized to zero. Each time a token is added, the counter is incremented by 1. Each time a unit of data is sent, the counter is decremented by 1. When the counter is zero, the host cannot send data.

The token bucket allows burst of traffic at a regulated maximum rate.

4.6.2.6 Resource Reservation in QoS

A flow of data basically needs resources such as a buffer, bandwidth, CPU time, and so on to maintain a steady flow. The quality of service is improved if these resources can be reserved in advance.

4.6.2.7 Admission Control in QoS

It is the mechanism used by a router, or a switch to accept or reject a flow based on predefined parameters called flow specifications.

Before a router accepts any flow for processing, it checks the flow specifications to check if its capacity and its previous commitments to other flows can handle the new flow.

CHECK YOUR PROGRESS

6. In transport layer, message is divided into _____.
7. Flow Control use _____ Protocol.
8. _____ is the measurement of the overall performance of a service.

9. _____ measures the number of bytes of user data transferred per second.
10. _____ and _____ are used for traffic shaping.
11. State true or false.
 - A. The leaky bucket algorithm allows idle host to accumulate credit.
 - B. Multiplexing can be only downward in transport layer.
 - C. Each packet in transport has it's sequence number.

Space for learners

4.7 DATA TRANSFER

Transport Layer provides transparent transfer of data between end users, providing reliable data transfer services to the upper layers. The transport layer controls the reliability of a given link by providing the following methods

- Error control
- Sequence control
- Loss control
- Duplication control

4.7.1 Error Control

When transferring data, the primary goal of reliability is that Data must be delivered to their destination exactly as they originated from the source. The reality of physical data transport is that while 100 percent error free delivery is probably impossible, transport layer protocols are designed to come as close as possible.

4.7.2 Sequence Control

The transport layer is responsible for ensuring that the data received from the upper layers are usable by the lower layers. On the receiving end, it is responsible for ensuring that the various sequence of a transmission are correctly reassembled.

4.7.3 Loss Control

The third aspect of reliability of data transfer covered by the transport layer is loss control. The transport layer ensures that all segments of the transmission arrive at the destination. When data have been segmented for delivery, some segments may be lost in transit. Sequence number allows the receiver's transport layer protocol to identify any missing segment and request for retransmission for the missing segment.

4.7.4 Duplication Controls

The fourth aspect of reliability of data transfer by the transport layer is duplication control. The transport layer guarantees that no duplicate data arrive at the destination. Sequence numbers allow the receiver to identify and discard duplicate segments.

4.8 CONNECTION MANAGEMENT

End to end delivery can be accomplished in two ways: connection oriented and connectionless. The connection-oriented mode is most commonly used from both two modes. A connection-oriented protocol establishes a virtual circuit or pathway between the sender and receiver. All of the packets belonging to a message are then sent over this same path.

In both cases, connections have three phases: Connection establishment, Data transfer and Connection termination.

4.8.1 Connection Establishment

Before communicating, device can send data to the other. The initializing device must first determine the availability of the other to exchange data and a pathway must be found through the network by which the data can be sent. This step is called connection establishment.

To establish a connection, one transport entity sends a CONNECTION REQUEST TPDU to the destination and waits for

CONNECTION ACCEPTED reply. The problem occurs when the network can lose, store, and duplicate packets.

The existence of delayed duplicates can be attacked in various ways.

The first technique prevents packets from looping. It is difficult because internets may range from a single city to international in scope. The second method uses the hop count. It is initialized to some appropriate value. The hop count is decremented each time the packet is forwarded. The network protocol simply discards any packet whose hop counter becomes zero.

In the third method, each packet bears the time it was created. The router discards any packet that is older than some given time. Three-way handshaking is used to solve the incorrect connection establishment.

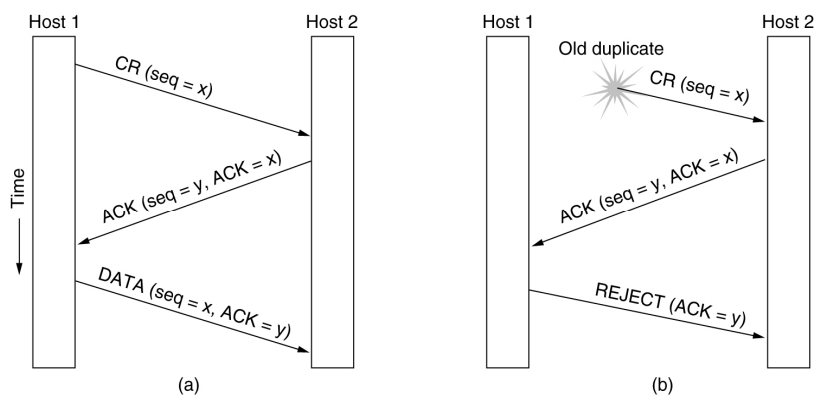

Figure 4.5: CR denotes CONNECTION REQUEST (a) Normal operation. (b) Old duplicate CONNECTION REQUEST

As given in figure 4.5 (a), the establishment protocol involves one peer checking with the other that the connection request is indeed current. Host 1 selects a sequence number x and sends a CONNECTION REQUEST segment carrying it to host 2. Host 2 responds with an ACK segment to acknowledge x and declares its own initial sequence number is y . Finally, host 1 acknowledges host 2's choice of an initial sequence number in the first data segment that it sends.

In figure 4.5 (b), the first segment is a delayed duplicate CONNECTION REQUEST from an old connection. This segment arrives at host 2 without host 1's knowledge. Host 2 responds to this

segment with an ACK segment. Host 2 asks for confirmation that host 1 was indeed trying to set up a new connection. When host 1 rejects host 2's attempt to establish a connection, host 2 realizes that it was misled by a delayed duplicate and leaves the connection. In this way, a delayed duplicate does no damage. The worst case is when both a delayed CONNECTION REQUEST and an ACK are floating around in the subnet.

Space for learners

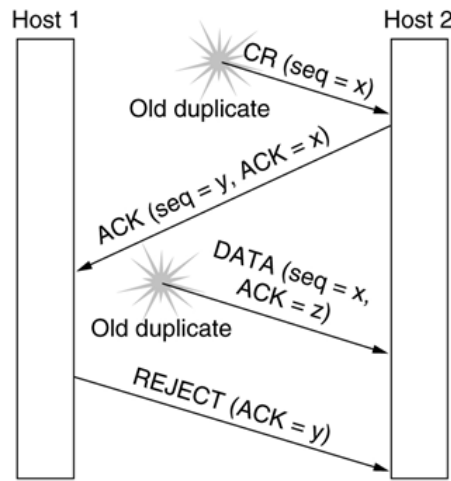

(c)

Figure 4.6: Duplicate CONNECTION REQUEST and duplicate ACK.

As presented in figure 4.6 the Duplicate Connection request, host 2 gets a delayed CONNECTION REQUEST and responds to it. It is crucial to realize at this point that host 2 has proposed using y as the initial sequence number for host 2 to host 1 traffic, knowing that no segments containing sequence number y or acknowledgements to y are still in existence. When the second delayed segment appears at host 2, z has been acknowledged before y tells host 2 that this is an old duplicate. The major thing to notice here is that there is no combination of old segments that can cause the protocol to fail and have a connection set up by accident when no one wants it

4.8.2 Connection Release

A connection is released using either asymmetric or symmetric variant. Asymmetric release is the way the telephone system works:

when one party hangs up, the connection is broken. Symmetric release treats the connection as two separate unidirectional connections and requires each one to be released separately. Data can be lost when connection is released. Figure 4.7 depicts how data is lost when it is disconnected.

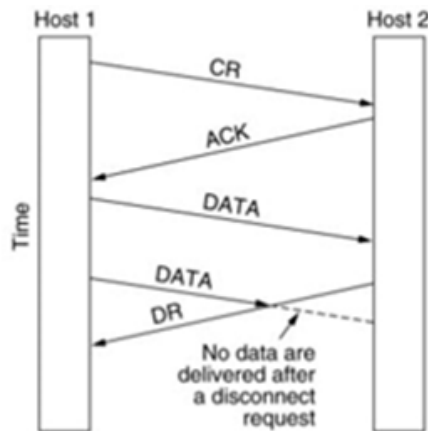

Figure 4.7: Disconnection with loss of data

But, the improved protocol for releasing a connection is a 3-way handshake protocol which is presented in figure 4.8.

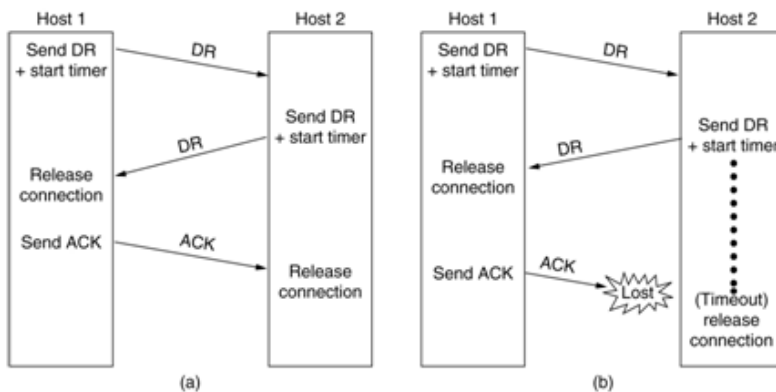

Figure 4.8: (a) Normal case of Three-way handshake (b) Final ACK lost

As shown in figure 4.8(a), one of the users sends a DISCONNECTION REQUEST TPDU to initiate connection release. When it arrives, the recipient sends back a DR-TPDU and starts a timer. When this DR arrives, the original sender sends back an ACK TPDU to releases the connection. Finally, when the ACK-TPDU arrives, the receiver also releases the connection.

In figure 4.8 (b), the initial process is same as the figure 4.8(a). The situation is saved by the time if the final ACK-TPDU is lost. When the timer is expired, the connection is released.

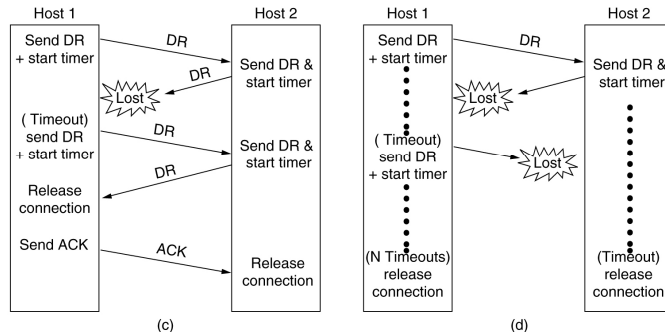

Figure 4.8: (c) Response lost. (d) Response lost and subsequent DRs lost.

In figure 4.8 (c), the user who wants to disconnect will not receive the expected response. It will timeout and starts again. In the second time, it assumes that all DR are delivered properly on time.

In figure 4.8 (d), it is same as figure 4.8(c) except all repeated attempts to retransmit the DR are assumed to be failed due to lost TPDU. After 'N' entries, the sender just gives up and releases the connection.

CHECK YOUR PROGRESS

12. Transport layer provides _____ data transfer.
13. _____ allows the receivers transport layer to identify any missing segment.
14. A _____ protocol establishes a virtual circuit between the sender and receiver.
15. State true or false
 - a. Incorrect connection establishment is solved by using hop count.
 - b. Connection management has three phases.
 - c. The error control at the transport layer is implemented across an individual link.

4.9 TRANSMISSION CONTROL MECHANISM

Transmission Control Mechanism can be defined as a standard that defines how to establish and maintain a network conversation through which application programs can exchange data. The type of

transport layer protocol an application chooses to use depends on the application requirement.

There are two main protocols in the transport layer: connectionless protocol and connection-oriented protocol. The protocols complement each other.

The connectionless protocol is UDP. It sends packets between applications, letting applications build their own protocols on top as needed. It provides no reliability or reordering of the data segment and flow control.

The connection-oriented protocol is TCP. It makes connections and adds reliability with retransmissions, along with flow control and congestion control.

4.9.1 User Datagram Protocol

User Datagram Protocol (UDP) provides connectionless, unreliable, datagram service. Connectionless service means that there is no logical connection between the two ends exchanging messages. Each message is an independent entity encapsulated in a datagram. The UDP header is shown in figure 4.9.

UDP does not need any connection between consequent datagram coming from the same source and going to the same destination.

UDP has an advantage: it is message-oriented. It gives boundaries to the messages exchanged. An application program may be designed to use UDP if it is sending small messages and the simplicity and speed is more important for the application than reliability.

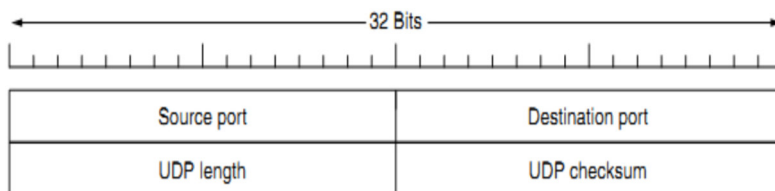

Figure 4.9: The UDP header

UDP packets, called *user datagram*, have a fixed-size header of 8 bytes made of four fields, each of 2 bytes (16 bits). The 16 bits can define a total length of 0 to 65,535 bytes. However, the total length needs to be less because a UDP user datagram is stored in an IP

datagram with the total length of 65,535 bytes. The two ports serve to identify the end-points within the source and destination machines.

UDP length includes 8-byte header and the data. UDP checksum includes the UDP header, the UDP data padded out to an even number of bytes if need be. It can carry the optional checksum. In UDP, a process sends messages with predefined boundaries for delivery. UDP adds its own header to each of these messages and delivers it to IP for transmission.

Each UDP packet is independent from other packets sent by the same application program. UDP does not provide error control. It provides an unreliable service. UDP is suitable for a process with internal flow- and error-control mechanisms. UDP is a suitable transport protocol for multicasting. Multicasting capability is embedded in the UDP software.

4.9.2 Transmission Control Protocol

Transmission Control Protocol (TCP) is a connection-oriented, reliable protocol. TCP explicitly defines connection establishment, data transfer, and connection teardown phases to provide a connection-oriented service. TCP provides process-to-process communication using port numbers. TCP allows the sending process to deliver data as a stream of bytes and allows the receiving process to obtain data as a stream of bytes.

Each machine that supports TCP has a TCP transport entity. This entity accepts user data streams from local processes and breaks them up into pieces not exceeding 64kbytes and sends each piece as a separate IP datagram. When these data grams arrive at a machine, the TCP entity reconstructs the original byte streams. It is up to TCP to time out and retransmits them as needed. It also reassembles datagram into messages.

4.9.2.1 The TCP Service Model

TCP service can be obtained by having both the sender and receiver creating end points. This end point is called **SOCKET**. Each socket has a socket number containing the IP address of the host and a 16 bit number local to that host, called a **PORT**. A connection must be

Space for learners

established between a socket on the source machine and a socket on the destination machine to get a TCP service.

Port numbers below 1024 are called Well-known ports and are reserved for standard services. For example, Port-21 is used to establish a connection to a host to transfer a file using FTP. Port-23 is used to establish a remote login session using TELNET.

TCP provides Full Duplex service, i.e., the data flow in both the directions at the same time.

4.9.2.2 TCP Protocol

The main feature of TCP is that every byte on a TCP connection has its own 32-bit sequence number. The primary protocol used by TCP entities is the sliding window protocol. It starts a timer while a sender transmits a segment. When the destination receives the segment, it sends back another segment containing an acknowledgement number equal to the next sequence number it expects to receive. The sender transmits the segment again if the acknowledgement is received after the sender's timer goes off.

The network layer, as a service provider for TCP, needs to send data in packets, not as a stream of bytes. At the transport layer, TCP groups a number of bytes together into a packet called a segment.

The segments are encapsulated in an IP datagram and transmitted. This entire operation is transparent to the receiving process.

STOP TO CONSIDER

An application establishes a connection with another application by binding a socket by a port number. Port number permits unique identification of several simultaneous processes using TCP/UDP. The Ports are used by TCP and UDP to deliver the data to the right application, are identified by a 16-bit number present in the header of a data packet. The three **types of Port are**

1. Well known port (0 to 1023)
2. Registered Port (1024-49159)
3. Dynamic port (49152-65535)

Space for learners

4.9.2.3 TCP Segment Header

Transmission Control Protocol accepts data from a data stream, segments it into chunks, and adds a TCP header creating a TCP segment. The TCP segment is then encapsulated into an Internet Protocol (IP) datagram. A TCP segment is the packet of information that TCP uses to exchange data with its peers. The segment consists of a header of 20 to 60 bytes, followed by data from the application program. The header is 20 bytes if there are no options and up to 60 bytes if it contains options. After the options, data bytes may follow. In data bytes, the first 20 refer to the IP header and the second to the TCP header. Segments without any data are legal and are commonly used for acknowledgements and control messages. TCP header is shown in figure 4.10.

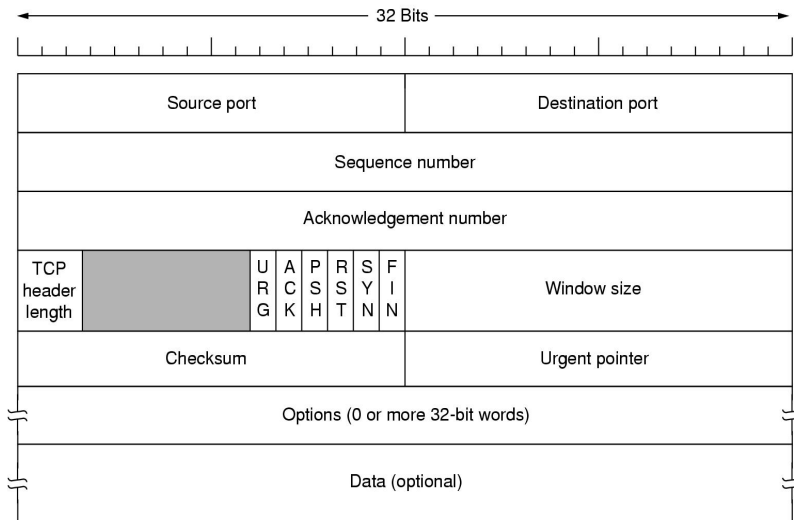

Figure 4.10: TCP Header

The Source port is a 16-bit field that defines the port number of the application program in the host that is sending the segment.

The Destination port address is a 16-bit field that defines the port number of the application program in the host that is receiving the segment. This port address identifies the local endpoint of the connection. Each host may decide for itself how to allocate its own ports starting at 1024.

The Sequence and ACK number are 32-bit fields used to give a sequence number to each and every byte transferred. This has an advantage over giving the sequence numbers to every packet

Space for learners

because data of many small packets can be combined into one at the time of retransmission, if needed. The ACK signifies the next byte expected from the source and not the last byte received.

The Header length tells how many 32-bit words are contained in the TCP header. This is needed because the options field is of variable length. The length of the header can be between 20 and 60 bytes.

There are six one-bit flags in the TCP header-

1. **URG:** This bit indicates whether the urgent pointer field in this packet is being used. It is set to 1 if URGENT pointer is in use, which indicates start of urgent data.
2. **ACK:** This bit is set to 1 to indicate the ACK number field in this packet is valid.
3. **PSH:** This bit indicates Pushed data. The receiver is requested to deliver the data to the application upon arrival and not buffer it until a full buffer has been received.
4. **RST:** This flag is used to reset a connection that has become confused due to a host crash or some other reason. It is also used to reject an invalid segment or refuse an attempt to open a connection.
5. **SYN:** This bit is used to establish connections. The connection request (1st packet in three-way handshake) has SYN=1 and ACK=0. The connection reply (2nd packet in 3-way handshake) has SYN=1 and ACK=1.
6. **FIN:** This bit is used to release a connection. It specifies that the sender has no more fresh data to transmit. However, it will retransmit any lost or delayed packet.

The Window Size field tells how many bytes may be sent starting at the byte acknowledged. Flow control in TCP is handled using a variable-size sliding window.

A Checksum is provided for extreme reliability. Its checksums the header, the data, and the conceptual pseudo header. The pseudo header contains the 32-bit IP address of the source and destination machines, the protocol number for TCP, and the byte count for the TCP segment including the header.

The Urgent Pointer indicates a byte offset from the current sequence number at which urgent data are to be found. Urgent data continues till the end of the segment.

The Options field provides a way to add extra facilities that are not included by the regular header.

The Data field can be of variable size. TCP knows its size by looking at the IP size header.

4.9.2.4 TCP Connection

To establish a connection, TCP uses a three-way hand shake mechanism.

Before a client attempts to connect with a server, the server must first bind to and listen at a port to open it up for connections: this is called a passive open. Here, BIND primitive is used to attach a local address to a socket and LISTEN primitive is used to announce the server is ready to accept a connection. Once the passive open is established, a client may initiate an active open.

A three-way handshake is established by using two flags:

Synchronization (SYN) flag and Acknowledge (ACK) flag.

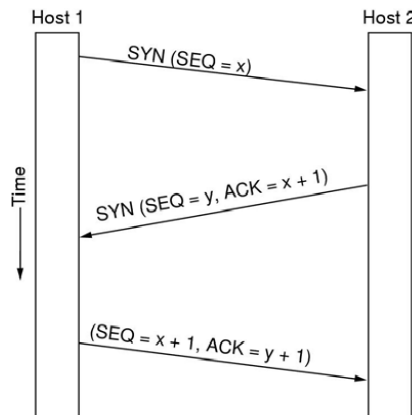

Figure 4.11: TCP connection establishment

Figure 4.11 presents a TCP connection establishment which works in the following steps.

Step 1 (SYN): The client sends a segment with SYN(Synchronize Sequence Number) which informs server that client wants to start communication. The client sets the segment's sequence number to a random value x.

Step 2 (SYN + ACK): Server responds to the client request with SYN-ACK signal bits set as seq=y, ACK=x+1. ACK signifies the

response of segment it received and set to one more than the received sequence number. SYN signifies the sequence number that the server chooses for the packet.

Step 3 (ACK): Finally, the client acknowledges the response of server. The sequence number is set to the received acknowledgement value i.e. $x + 1$ and the acknowledgement number is set to one more than the received sequence number i.e. $y + 1$. Then they both establish a reliable connection with which they will start the actual data transfer.

The steps 1, 2 establish the connection parameter (sequence number) for one direction and it is acknowledged. The steps 2, 3 establish the connection parameter (sequence number) for the other direction and it is acknowledged. Thus, a full-duplex communication is established.

4.9.2.5 TCP Connection Release

It is known that the TCP connections are full duplex. But to discuss how connections are released, it is best to consider the connection as a pair of simplex connections.

The initiator sends a TCP packet and its FIN bit is set. The Fin bit of the packet informs the application program of the responder that it has no more data to transmit. When the responder acknowledges the FIN, the connection is closed from one side.

The responder on receiving this informs the application program that it will receive no more data and sends an acknowledgement of the packet. The connection is now closed from one side. Now the responder will follow similar steps to close the connection from its side. Once this is done the connection will be fully closed.

Generally, to release a connection, four TCP segments one FIN and one ACK for each direction are needed.

4.10 FLOW CONTROL

Transport layer flow control uses a sliding window protocol on each connection to keep a fast transmitter from over running a slow receiver. Sliding window is used to make data transmission more efficient as well as to control the flow of data so that the receiver does not become overwhelmed. The window at the transport layer

Space for learners

can vary in size to accommodate buffer occupancy as depicted in figure 4.12 given below.

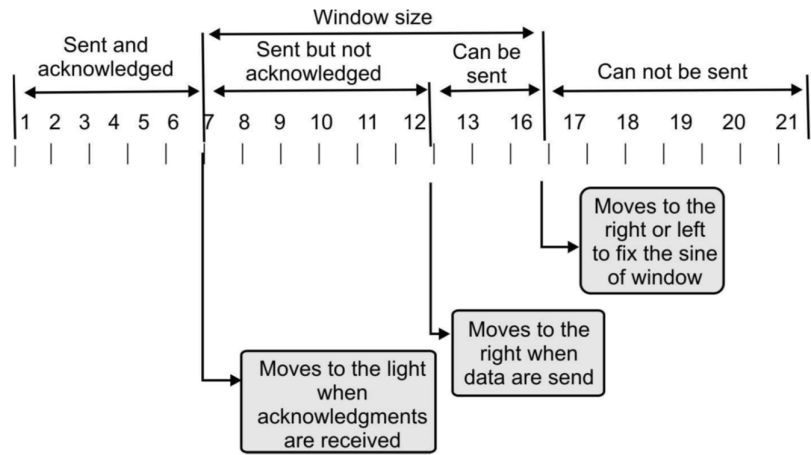

Figure 4.12: Sliding Window for Flow Control

The transport entity uses a modified form of sliding window protocol for flow control. Some points about sliding window at the transport layer are as follows:

1. Sender does not have to send a full window's worth of data.
2. An acknowledgement can expand the size of the window based on the sequence number of the acknowledged data segment.
3. The size of the window can be increased as decreased by the receiver.
4. The receiver can send acknowledgement at any time.

Buffering must be done by the sender, if the network service is unreliable. The sender buffers all the TPDU's sent to the receiver. If the sender knows that the receiver always has buffer space, it needs not to keep TPDU's it sends. The buffer size varies for different TPDU's. They are:

- a) Chained Fixed-size Buffers
- b) Chained Variable-size Buffers
- c) One large Circular Buffer per Connection

All these three types of buffer size are presented in figure 4.13.

Space for learners

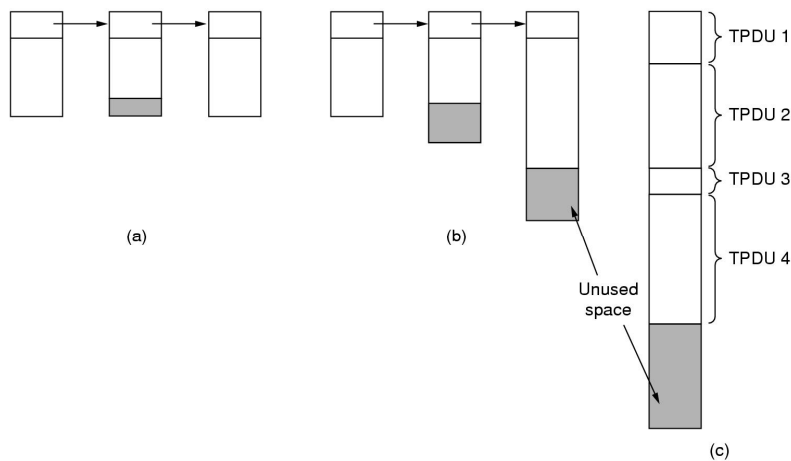

Figure 4.13: (a) Chained fixed-size buffers. (b) Chained variable-sized buffers. (c) One large circular buffer per connection.

(a) Chained Fixed-size Buffers:

The buffers can be ordered as a pool of similar size buffers as one TPDU per buffer if the majority of TPDU's are almost of the equal size.

(b) Chained Variable-size Buffers:

If there is broad variation in TPDU size, it leads to the buffer size problem. The buffer space will be wasted on the arrival of a short TPDU if the buffer size is selected equal to the largest possible TPDU. When the buffer size is chosen less than the maximum TPDU size, multiple buffers will be needed for long TPDU's.

So, variable-size buffers are used to solve these problems.

(c) One large Circular Buffer per Connection:

When all connections are heavily loaded, a single large circular buffer per connection is allocated. The type of traffic determines the optimum trade-off between source and destination buffering-

1. **Source Buffering is used for low** band width bursty traffic.
2. Destination Buffering is used for high band width smooth traffic.
3. Dynamic Buffering is used if the traffic pattern changes randomly.

Space for learners

CHECK YOUR PROGRESS

16. TCP and UDP are called _____ protocol.
17. UDP packets are called_____.
18. To achieve reliable transport in TCP, _____ is used to check the safe and sound arrival of data.
19. Port number below _____are called well-known port.
20. UDP header is of size_____.
21. State true or false
 - a. In TCP header, the source and destination port is of 16 bit field.
 - b. ACK flag in TCP header specifies that the sender has no more data to transmit.
 - c. In TCP connection, three-way handshake is established using Syn and Ack flag.

Space for learners

4.11 SUMMING UP

- Transport layer is mainly responsible for end-to-end reliable delivery, segmentation and concatenation. It provides the communication services directly to the application processes running on different hosts.
- The transport layer services are specified by a set of primitives through which user can access those service.
- The Transport Protocol Data Unit (TPDU) is used for messages sent from transport entity to transport entity.
- The data link layer and the transport layer perform many same duties. The data link layer works on a single network while the transport layer operates across an internet. Transport layer works on port address.
- Multiplexing can be downward or upward in transport layer.
- Flow control at the transport layer is handled by the Sliding Window to prevent the sender from overwhelming the receiver.

- The connectionless transport layer treats each packet as independent and delivers it to the destination.
- The connection-oriented transport layer first makes connection then send the data.
- Quality of service can be determined mainly from reliability, delay, Jitter and bandwidth.
- Transport layer provides reliable data transfer by error control, sequence control, loss control and duplication control.
- Connection establishment can be done by using three-way handshakes to handle the delayed duplicate.
- Transport layer has two main protocols UDP and TCP. UDP is a connectionless protocol which provides unreliable datagram service. TCP is a connection-oriented protocol which provides a reliable end-to-end byte stream over an unreliable internetwork.

Space for learners

4.12 ANSWERS TO CHECK YOUR PROGRESS

1. 4
2. Transport Layer
3. Network Layer
4. Transport protocol Data Unit (TPDU)
5. a. True b. True c. False
6. Segment
7. Sliding Window Protocol
8. QOS
9. Throughput
10. Leaky Bucket and Token Bucket
11. a. False b. False c. True
12. Reliable
13. Sequence Number
14. Connection-Oriented
15. a. False b. True c. False

- 16. Transport
- 17. Datagram
- 18. Acknowledgment
- 19. 1024
- 20. 8 byte
- 21. a. True b. False c. True

Space for learners

4.13 POSSIBLE QUESTIONS

Short answer type questions:

1. What are the main services that the transport layer provides to its upper layer?
2. What is Addressing?
3. What is Connection Establishment Delay?
4. What is meant by QOS?
5. What do you mean by packet scheduling?
6. What is Leaky Bucket algorithm?
7. Define sequence control.
8. Define the transport layer connection establishment.
9. What is Transmission control protocol (TCP)?
10. What do you mean by UDP?
11. Define TCP service model.
12. Define flow control.
13. What do you mean by checksum field present in TCP header?

Long answer type questions:

1. How can the transport layer service be accessed by user. Explain the transport service primitives.
2. Explain the types of service provided by the transport layer.
3. What is Multiplexing? Explain
4. Explain briefly the main requirements of QOS.

5. Explain one technique that is used to control traffic sent to a network.
6. How does the transport layer control the reliability of data transfer? Explain.
7. Explain briefly the transport layer connection establishment with three-way handshaking.
8. Explain UDP.
9. Explain TCP Segment Header briefly.
10. How can TCP connection be established using SYN and ACK flags?
11. Explain the different flags present in TCP header.
12. Explain the importance of buffering in flow control.

4.14 REFERENCES AND SUGGESTED READINGS

1. Tanenbaum, Andrew S. Computer Network. Pearson.
2. James, F. Kurose, Keith, W. Ross. Computer Networking. A Top-Down Approach. Pearson.
3. <http://www.vbspu.ac.in/wp-content/uploads/2020/05/CN-Notes.pdf>

Space for learners

UNIT 5: THE TRANSPORT LAYER: THE PROTOCOLS

Space for learners

Unit Structure:

- 5.1 Introduction
- 5.2 Unit Objectives
- 5.3 Responsibilities of Transport Layer
- 5.4 User Datagram Protocol (UDP)
 - 5.4.1 Structure of UDP datagram
 - 5.4.2 Applications of UDP
 - 5.4.3 Disadvantages of UDP
- 5.5 Transmission Control Protocol (TCP)
 - 5.5.1 Structure of TCP segment
 - 5.5.2 TCP Connection Management
 - 5.5.3 TCP Flow Control
 - 5.5.4 TCP Congestion Control
- 5.6 Socket Interface
 - 5.6.1 Socket Types
 - 5.6.2 Socket Creation
 - 5.6.3 Binding Local Names
 - 5.6.4 Connection Establishment
 - 5.6.5 Data Transfer
 - 5.6.6 Closing Sockets
- 5.7 Remote Procedure Call
- 5.8 Summing Up
- 5.9 Answer to Check your progress
- 5.10 Possible Questions
- 5.11 References and Suggested Readings

5.1 INTRODUCTION

Transport Layer is the second layer of the TCP/IP model. It is an end-to-end layer which is used to deliver messages to a host. It is termed as an end-to-end layer because transport layer protocols provide point-to-point connections rather than hop-to-hop, between two specific networked devices i.e., source node and destination node to deliver the services consistently. Transport layer

allows multiple networking applications that reside above the transport layer to establish client-server, point-to-point communication links to another device.

The two most significant protocols in the Transport Layer are *Transmission Control Protocol (TCP)* and *User Datagram Protocol (UDP)*.

TCP is the more sophisticated protocol of the two which is used for applications that need connection establishment before actual data transmission. TCP provides reliable data delivery service with end-to-end error detection and correction. Applications such as E-mail, file transfer, remote terminal access, connecting to internet, virtual private networking etc. are based on TCP.

UDP is a much simpler protocol than TCP. It provides low-overhead, connectionless datagram delivery service and does not guarantee the delivery of data to the destination. It is the responsibility of application layer protocols to make UDP as reliable as possible. Network Time Protocol (NTP), Domain Name Service (DNS), Network News Protocol (NNP) use UDP as a transport layer protocol.

In this unit we will go into details on these two protocols.

5.2 UNIT OBJECTIVES

After going through this unit, you should be able to:

- explain the responsibilities of the Transport Layer
- understand TCP and UDP header formats
- learn how to establish and release TCP connections
- know the congestion mechanism in TCP
- explain remote procedure call
- discuss about socket interface

5.3 RESPONSIBILITIES OF TRANSPORT LAYER

The transport layer has a critical role in providing end-to-end communication to the directly application processes. It takes the data from the upper layer, and it divides the data into smaller

Space for learners

packets and then transmits them to the network layer. The purposes of transport layer are presented in figure 5.1.

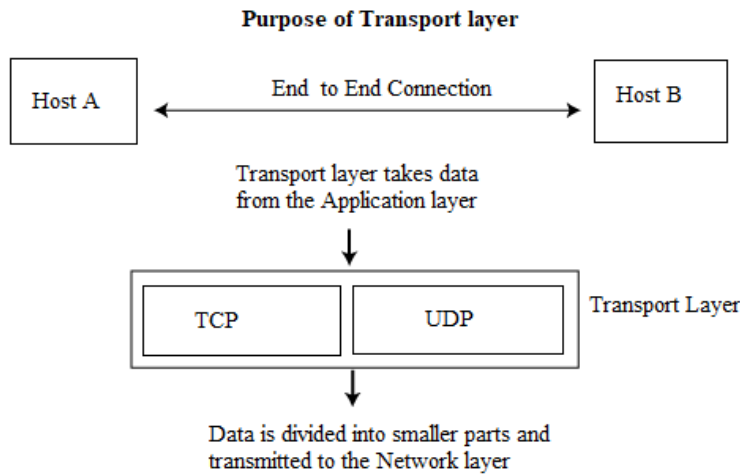

Figure 5.1: Purposes of Transport layer

Transport Layer has the following responsibilities

- **Process to process delivery:** While Data Link Layer requires the MAC Addresses and Network layer requires the IP address for appropriate routing of packets, in a similar way transport layer requires a port number to appropriately deliver the data segments to the correct process among the several processes running on a particular host. A port number is a 16-bit address which helps to uniquely identify any client-server program.
- **End-to-end Connection between hosts:** The transport layer is responsible for making the end-to-end connection among networked devices for which it mainly uses TCP and UDP.
- **Multiplexing and Demultiplexing:** Multiplexing allows concurrent use of different applications over a network that is running on a host. The transport layer provides this mechanism which enables us to send packet streams from various applications simultaneously over a network. Similarly, Demultiplexing is essential at the receiver side to acquire the data coming from various processes.
- **Congestion Control:** Congestion is a situation in which too many sources over a network attempt to send data and the router buffers start overflowing due to which loss of packets

Space for learners

occur. As a result, re-transmission of packets from the sources increases the congestion further. In this situation, the transport layer uses open loop congestion control to prevent the congestion and closed loop congestion control to remove the congestion in a network once it occurred.

- **Data integrity and Error correction:** The transport layer checks for errors in the data units coming from the application layer by using error detection codes. It computes checksums to verify that the received data is not corrupted. Transport layer uses the ACK (acknowledgement) NACK (negative acknowledgement) services to inform the sender whether the data has arrived or not and checks for the integrity of data.
- **Flow control:** The transport layer provides a flow control mechanism between the adjacent layers of the TCP/IP model. TCP prevents data loss due to a fast sender and slow receiver by imposing some flow control techniques. Transport layer uses the sliding window protocol for informing the sender the size of the data that can be accepted by the receiver.

Space for learners

CHECK YOUR PROGRESS - I

1. Transport layer aggregates data from different applications into a single stream before passing it to
 - a) network layer
 - b) data link layer
 - c) application layer
 - d) physical layer
2. Which of the following are transport layer protocols used in networking?
 - a) TCP and FTP
 - b) UDP and HTTP
 - c) TCP and UDP
 - d) HTTP and FTP

5.4 USER DATAGRAM PROTOCOL (UDP)

The User Datagram Protocol is an unreliable, connectionless datagram protocol. There are no techniques in the protocol for verifying that the data reached the other end of the network correctly. There is no assurance that the message will reach the destination. Due to this, there is a possibility that messages may arrive at a random order in the receiving process. Moreover, there is no need to establish a connection prior to data transfer.

5.4.1 Structure of UDP datagram

The packet produced by UDP is called a *datagram*. A UDP datagram consists of a *header* and a *data* section. Figure 5.2 shows the structure of UDP datagram.

The first 8 bytes contains all necessary header information and the remaining part consist of data.

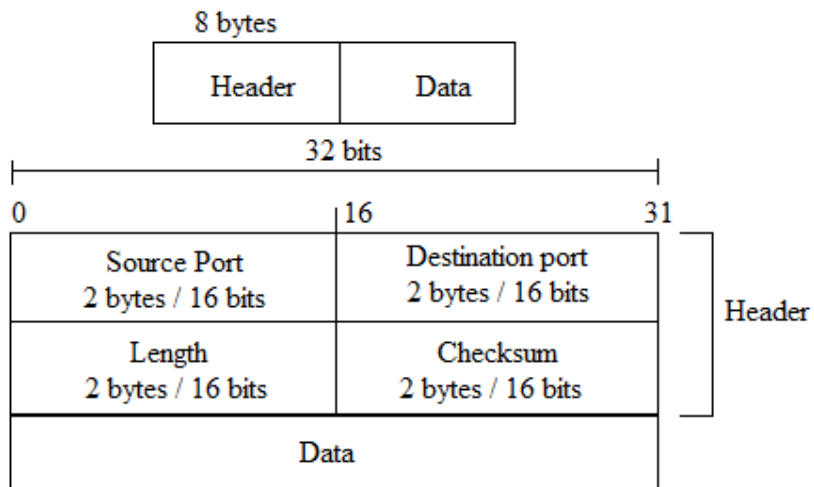

Figure 5.2: Structure of UDP datagram

The UDP header has only four fields, each consisting of two bytes. Let us discuss each field briefly:

- **Source Port:** It is used to identify the port number of the source. Since the length is 16 bits, the range for port numbers is defined from 0 to 65535.
- **Destination Port:** It is used to identify the port of the destined packet.

Space for learners

- **Length:** It specifies the length of UDP including the header and the data.
- **Checksum:** The checksum is used by the receiving node to check whether errors have been introduced into the arrived data segment. Checksum is the 16-bit 1's complement of the 1's complement sum of the UDP header, the pseudo-header of information from the IP header, and the data, padded with zero octets at the end (if necessary) to make a multiple of two octets.

The application data occupies the data field of the UDP segment. For example, for a streaming audio application, audio samples fill the data field.

5.4.2 Applications of UDP

UDP does not provide a congestion-control service. Hence, the sender can push data into a UDP socket at any rate. Then what is the necessity of such a protocol at the transport layer? There are certain types of applications such as real time applications which can bear some loss but require a minimum rate. Real-time applications often pick the UDP to run because these applications cannot wait for acknowledgements for data input. There are many applications, which are better suited for UDP for the following reasons.

- **No connection establishment:** Since UDP does not cause any delay in establishing a connection, it works faster.
- **More Client support:** TCP maintains connection state in the end hosts. This connection state comprises of receiving and sending buffers, congestion control parameters along with sequence and acknowledgement number parameters. UDP, on the contrary, does not preserve connection state and does not track any of these parameters. A server devoted to a particular application can typically support many more active clients when the application runs over UDP rather than TCP.
- **Small packet header overhead:** The TCP segment has 20 bytes of header overhead in every segment, whereas UDP has only eight bytes of overhead.

Space for learners

Few examples of applications which uses UDP protocol are Domain Name Service (DNS), Remote file server, streaming media, internet telephony, network management, routing protocol such as Routing Information Protocol (RIP), Network News Protocol (NNP) and Network Time Protocol (NTP).

Space for learners

5.4.3 Disadvantages of UDP

UDP provides basic functionalities required for the end-to-end delivery of a transmission. This protocol does not provide any sequencing or reordering functions and does not specify the damaged packet while reporting an error. UDP can discover that an error has occurred, but it does not specify which packet has been lost since it does not contain an ID or sequencing number of a specific data segment.

CHECK YOUR PROGRESS - II

1. User datagram protocol is called connectionless because
 - a) all UDP packets are treated independently by transport layer
 - b) it sends data as a stream of related packets
 - c) it is received in the same order as sent order
 - d) it sends data very quickly
2. What is the header size of a UDP packet?
 - a) 8 bytes
 - b) 8 bits
 - c) 16 bytes
 - d) 124 bytes
3. The _____ field is used to detect errors over the entire user datagram.
 - a) UDP header
 - b) checksum
 - c) source port
 - d) destination port

5.5 TRANSMISSION CONTROL PROTOCOL (TCP)

Applications that require the transport protocol to provide reliable data delivery use TCP because it verifies that data is transported across the network precisely and in the proper sequence. TCP is a reliable and connection-oriented protocol.

TCP provides reliability with a mechanism called Positive Acknowledgment with Re-transmission (PAR). A system using PAR sends the data again, except it hears from the receiver that the data arrived okay. If the data segment is received undamaged, the receiver sends a positive acknowledgment back to the sender. If the data segment is damaged, the receiver rejects it. After an appropriate time-out period, the sending TCP module re-transmits any segment for which no positive acknowledgment has been received.

TCP is connection-oriented. It creates a logical end-to-end connection between the two interacting hosts. Control information, called a handshake, is exchanged between the two endpoints to establish a dialogue before data is transmitted.

Space for learners

5.5.1 Structure of TCP Segment

TCP uses only a single type of protocol data unit, called a TCP segment. The TCP segment header with other fields is shown in figure 5.3.

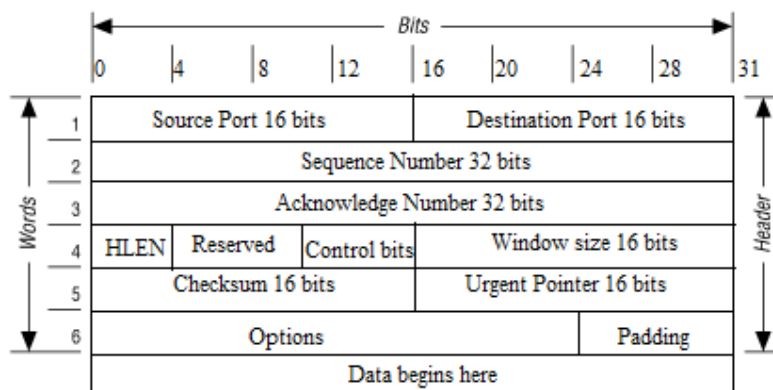

Figure 5.3 Structure of TCP segment

The fields are:

Source port: It is a 16-bit field and is used to define the address of the application program in a source node.

Destination port: It is used to define the address of the application program in a destination node. It is also a 16-bit field.

Sequence number: The 32-bit sequence number field represents the position of the data in an original data stream.

Acknowledgement number: A 32-bitfield acknowledgement number recognizes the data from other communicating hosts. If ACK flag of control bits is set to 1, then it specifies the sequence number that the receiver is expecting to receive.

Header Length (HLEN): It is a 4-bit field that specifies the size of the TCP header in 32-bit words (4 bytes). The minimum size of the TCP header is 5 words (i.e., 20 bytes) and the maximum size of the TCP header is 15 words (i.e., 60 bytes).

Reserved: It is a 6-bit field which is reserved for future use.

Control bits: A control bit defines the use of a segment or serves as a validity check for other fields.Each bit of a control field functions separately and autonomously. There are 6 types of flags in control field:

- *URG*: The *URG* field indicates that the data in a segment is urgent.
- *ACK*: When *ACK* field is set, then it validates the acknowledgement number.
- *PSH*: It is used to notify the sender that higher throughput is needed so, if possible, data must be pushed with higher throughput.
- *RST*: The reset bit is used to reset the TCP connection when there is any confusion occurs in the sequence numbers due to host crash or some other reason.
- *SYN*: The *SYN* field is used to synchronize the sequence numbers in three types of segments: connection request, connection confirmation (with the ACK bit set), and confirmation acknowledgement.

Space for learners

- **FIN:** The *FIN* field is used to update the receiver that the sender has finished sending data. It is used to release a connection and no more data transfer will occur.

Window Size: The window is a 16-bit field that defines the size of the receiving window. The value of this field is determined by the receiver and indicates the amount of buffer allocated by the receiver for a data segment. It is used for the flow control between the sender and receiver.

Checksum: The checksum is a 16-bit field used in error detection. It provides extra reliability. It checksums the header, the data and conceptual pseudo header. The checksum algorithm simply adds up all the 16-bit words in 1's complement and then takes 1's complement of the sum. Accordingly, when the receiver makes calculations on the entire segment including the checksum field, the result must be 0.

Urgent pointer: If URG flag is set to 1, then this 16-bit field is an offset from the sequence number indicating that it is a last urgent data byte.

Options and padding: It defines the optional fields that convey the additional information to the receiver.

A Segment with no data is used, for controlling messages and acknowledgements.

5.5.2 TCP Connection Management

Before data transmission, a connection must be established. Connection establishment must take into account the unreliability of a network service, which leads to a loss of data units. TCP provides reliable communication with the help of Positive Acknowledgement with Re-transmission (PAR). The protocol data unit (PDU) of the transport layer is termed *segment*. A device using PAR resends the PDU until it receives an acknowledgement. If the data unit received at the receiver's end is damaged (checks the data with checksum functionality for error detection), the receiver discards the *segment*. The sender has to resend the data unit for which positive acknowledgement is not received. It can be understood from the above mechanism that three data segments are exchanged between sender and receiver for a reliable TCP connection to get established.

Space for learners

The following figure 5.4 illustrates this typical *three-way handshake* operations:

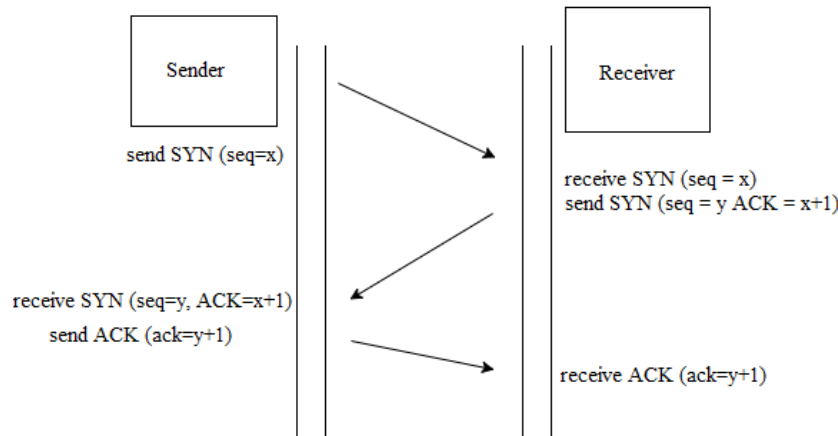

Figure 5.4: TCP 3-way handshaking

- **Step 1 (SYN):** In the first step, the sender wants to establish a connection with the receiver, so it sends a segment with SYN(Synchronize Sequence Number) which informs the receiver that the sender is likely to start communication and with what sequence number it starts segments with.
- **Step 2 (SYN + ACK):** Receiver replies to the sender's request with SYN and ACK signal bits set. Acknowledgement (ACK) indicates the response of the segment it received and SYN implies with what sequence number it is likely to start the segments with.
- **Step 3 (ACK):** In the final step, sender acknowledges the response of the receiver and they both establish a reliable connection.

After this exchange, sender's TCP has positive evidence that the receiver's TCP is alive and ready to receive data. As soon as the connection is established, data can be transferred.

TCP views the data it sends as a continuous stream of bytes, not as independent packets. Thus, TCP takes care to keep the sequence in which bytes are sent and received. The Sequence Number and Acknowledgment Number fields in the TCP data segment header keep track of the bytes.

When a data segment arrives that is in sequence, the receiving TCP entity has two options concerning the timing of acknowledgment:

Space for learners

- *Immediate*: When data are accepted, instantly transmit an empty segment (no data) containing the appropriate acknowledgment number.
- *Cumulative*: When data are accepted, record the need for acknowledgment, but wait for an outbound segment with data on which to piggyback the acknowledgement. To avoid a long delay, set a window timer. If the timer expires before an acknowledgement is sent, transmit an empty segment containing the appropriate acknowledgment number.

When the sender and receiver have concluded the data transfers, they will exchange a three-way handshake with segments containing the "No more data from sender" bit (called the FIN bit) to close the connection. It is the end-to-end exchange of data that provides the logical connection between the two systems.

5.5.3 TCP Flow Control

TCP offers many services to the application process. Flow Control is one such service. Flow Control basically means that TCP will ensure that a sender is not overwhelming a receiver by sending packets faster than it can consume.

At the receiver's buffer, TCP uses *sliding window with credit scheme* to handle flow control. The scheme provides the receiver with a greater degree of control over data flow.

Now, let us understand this scheme. Assuming that the sender desires to send application data to the receiver. The receiver has 4 K byte buffer which is vacant as shown below:

- 1) Initially buffer size = 4K bytes

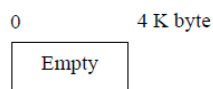

- 2) Sender transmits 2 K byte segment (data) with sequence number 0 as shown below

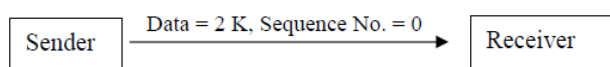

- 3) The packet is examined at the receiver. After that, it will be acknowledged by it. It will also specify the credit value (window size) of the receiver. Till the application process running at the receiver side removes some data from buffer, its buffer size remains constant at 2048. Therefore, credit value (window size) is 2048 byte.

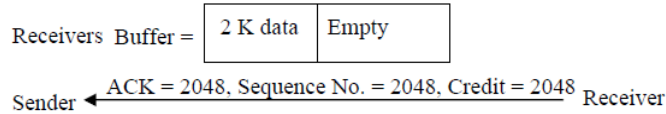

- 4) Now, the sender transmits another 2048 bytes, which is accepted, then the advertised window (credit) will be updated to 0.

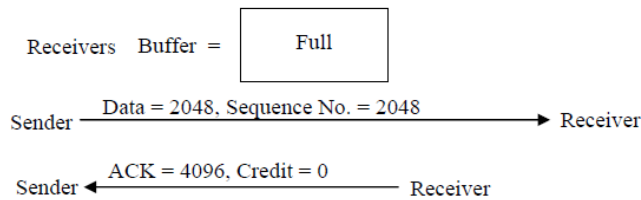

- 5) The sender must halt sending data until the application process on the receiving host has removed some data from the buffer, at which time TCP can advertise, a large window (credit value).

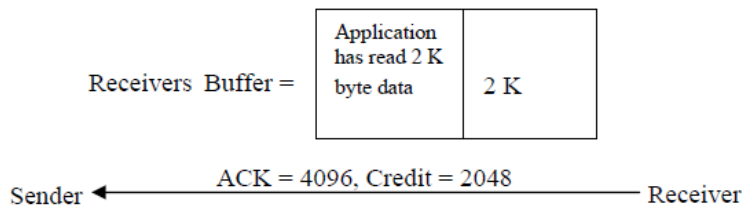

When the credit size is zero, normally there is no communication from the sender side except in two situations:

- a) Urgent data requires to be sent.
- b) Sender wants to know the credit size and the next byte expected by the receiver.

Both senders and receivers can delay the transmission from their side to optimize resources. If a sender knows that the buffer capacity of a receiver window is 8 K and currently it has received just 2 K, then it may buffer it at the sender side till it gets more data from the

Space for learners

application process. Similarly, the receiver has to send some data to the sender it can delay the acknowledgement till its data is ready for that the acknowledgement can be piggybacked. Therefore, the basic reason of delaying the acknowledgement is to reduce the bandwidth.

Space for learners

5.5.4 TCP Congestion Control

Another important service that TCP provides is Congestion Control. Congestion is a state occurred in the network layer when the message traffic is so heavy that it slows down network response time. TCP uses end-to-end congestion control rather than the network supported congestion control, since the IP Protocol does not provide congestion released support to the end system.

It's important to understand that this is not the same as flowcontrol. Although there's some intersection between the mechanisms TCP uses to provide both services, they are separate features. Congestion control is about preventing a node from overwhelming the network (i.e., the links between two nodes), while Flow Control is about the end-node.

The basic idea of TCP congestion control is to have each sender transmits just the right amount of data to keep the network resources utilized but not overloaded. If senders are too aggressive and send too many packets, the network will experience overcrowding of data packets. On the other hand, if TCP senders are too conservative, the network will be under-utilized. The maximum number of bytes that a TCP sender can transmit without congesting the network is specified by another window called the **congestion window**. To bypass network congestion and receiver buffer overflow, the maximum amount of data that the TCP sender can transmit at any time should be the minimum of the receiver window and the congestion window. If the receiver advertises for 4K window but the sender sends 2K size of data if it thinks that 4K congesting the network, then the effective windows size is 2K.

The TCP congestion control algorithm dynamically adjusts the congestion window according to the network state. The algorithm is called **slow start**. Figure 5.5. presents Congestion control employing Slow start algorithm. The operation of the TCP congestion control algorithm may be divided into three phases:

- 1) *Slow Start Phase*

2) *Congestion Avoidance Phase*

3) *Congestion Detection Phase*

Slow Start Phase (exponential increment): The first phase is run when the algorithm starts or restarts, assuming that the network is empty. The technique, slow start, is accomplished by first setting the congestion window to one maximum-size segment. Each time the sender obtains an acknowledgement from the receiver, the sender increases the congestion window by one segment. After transmitting the first segment, if the sender receives an acknowledgement before a time-out, the sender increases the congestion window to two segments. If these two segments are acknowledged, the congestion window increases to four segments, and so on. The congestion window size grows exponentially during this phase. The reason for the exponential increase is that slow start needs to fill an empty pipe as quickly as possible.

Initially congestion window $cwnd=1$

After 1 Round Trip Time (RTT) $cwnd = 2^1 = 2$

After 2 RTT $cwnd = 2^2 = 4$

After 3 RTT $cwnd = 2^3 = 8$

Slow start does not increase the congestion window exponentially forever, since the network will be filled up eventually. Specifically, slow start stops when the congestion window reaches a value specified as the congestion threshold, which is initially set to 65,535 bytes.

Congestion Avoidance Phase (additive increment): When the congestion window reaches the threshold value, congestion avoidance phase takes over. This phase assumes that the network is running close to full utilization. It is wise for the algorithm to reduce the rate of increase so that it will not overshoot excessively. Specifically, the algorithm increases the congestion window linearly rather than exponentially when it tries to avoid congestion. This is realized by increasing the congestion window by one segment for each round-trip time.

After each RTT $cwnd = cwnd + 1$

Congestion Detection Phase (multiplicative decrement): The congestion window cannot be increased indefinitely. The congestion window stops increasing when TCP detects that the network is

Space for learners

congested. The algorithm now enters the third phase. How does TCP detect network congestion? There are two approaches:

i) Retransmission due to timeout – In this case congestion possibility is high. At this point threshold is reduced to half of the current window size. Next the congestion window is reset to one and the algorithm restarts, using the slow start technique

threshold is reduced to half of the current window size

set cwnd = 1

start with slow start phase again.

ii) Retransmission due to duplicate acknowledgement: In this case, congestion possibility is less. TCP decreases the congestion threshold to one-half of the current window size, as before. However, the congestion window is not reset to one. If the congestion window is less than the new congestion threshold, then the congestion window is increased as in slow start. Otherwise, the congestion window is increased as in congestion avoidance.

threshold is reduced to half of the current window size

set cwnd = threshold

start with the congestion avoidance phase.

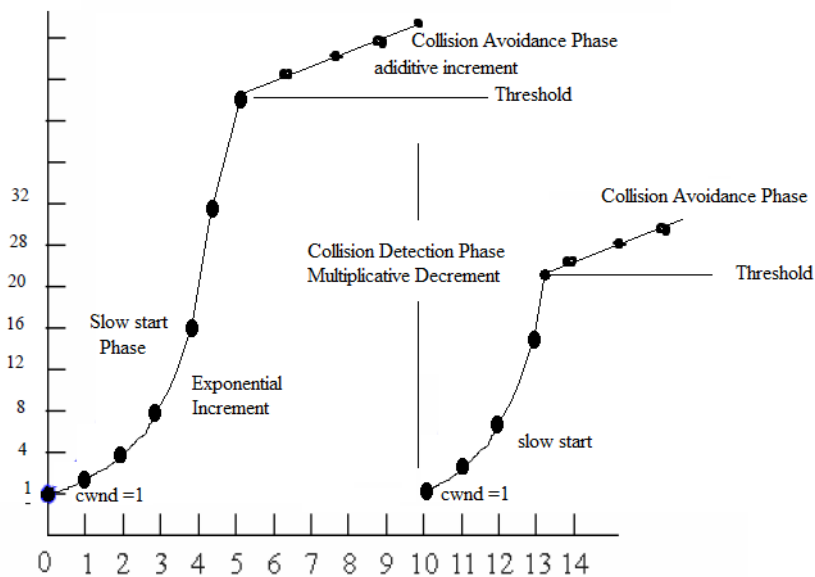

Figure 5.5: Congestion control using slow start algorithm

CHECK YOUR PROGRESS - III

1. There are two protocols at the transport layer, which of the two is better?
2. In the slow start phase of the TCP congestion control algorithm, the size of the congestion window
 - a) does not increase
 - b) increases linearly
 - c) increases quadratically
 - d) increases exponentially
3. Transmission control protocol
 - a) is a connection-oriented protocol
 - b) uses a three-way handshake to establish a connection
 - c) receives data from application as a single stream
 - d) all of the above
4. The receiver of the data controls the amount of data that are to be sent by the sender is referred to as
 - a) Flow control
 - b) Error control
 - c) Congestion control
 - d) Error detection
5. Size of TCP segment header ranges between
 - a) 16 and 32 bytes
 - b) 16 and 32 bits
 - c) 20 and 60 bytes
 - d) 20 and 60 bits
6. Connection establishment in TCP is done by which mechanism?
 - a) Flow control
 - b) Three-Way Handshaking
 - c) Forwarding
 - d) Synchronization

Space for learners

5.6 SOCKET INTERFACE

Sockets are the most commonly used low-level interface to network protocols. A socket has a type and one associated process. Sockets were designed to implement the client-server model for interprocess communications where:

- The interface to network protocols needs to accommodate multiple communication protocols, such as TCP/IP, Xerox internet protocols (XNS), and UNIX family.

- The interface to network protocols needs to put up server code that waits for connections and client code that initiates connections.

Sockets behaves like UNIX files. Applications create sockets when they are needed. Sockets work with the *read()*, *write()*, *ioctl()*, *fcntl()* and *close()* interfaces. It is the responsibility of the operating system to differentiate between the file descriptors for files and the file descriptors for sockets.

5.6.1 Socket Types

Socket types define the communication properties visible to a user. There are three types of sockets:

- **SOCK_STREAM:** Stream socket allows processes to communicate using TCP. It provides bidirectional, reliable, sequenced, and unduplicated flow of data with no record boundaries. After the connection has been established, data can be read from and written to these sockets as a byte stream.
- **SOCK_DGRAM:** Datagram sockets allow processes to use UDP to communicate. A datagram socket provides support for bidirectional flow of messages. A process on a datagram socket can accept messages in a dissimilar order from the sending sequence and can receive duplicate messages.
- **SOCK_RAW:** Raw sockets are normally datagram oriented. They provide access to ICMP. They are provided to support developing new communication protocols or for access to more esoteric facilities of an existing protocol. These raw sockets are not meant for most of the applications, only superuser processes can use raw sockets.

5.6.2 Socket Creation

The *socket()* call creates a socket in the specified family and of the specified type.

s = socket(family, type, protocol);

Space for learners

If the protocol is unspecified (a value of 0), the system selects a protocol that supports the requested socket type. It returns a file descriptor i.e., handle for the created socket.

The family is specified by one of the constants defined in *sys/socket.h*. Constants named *AF_suite* specify the address format to use in interpreting names, as shown in the following list

- *AF_APPLETALK* : Apple Computer Inc. Appletalk network
- *AF_INET6* : Internet family for IPv6 and IPv4
- *AF_INET* : Internet family for IPv4 only
- *AF_PUP* : Xerox Corporation PUP internet
- *AF_UNIX* : Unix file system

Socket types are defined in *sys/socket.h*. *SOCK_STREAM*, *SOCK_DGRAM*, or *SOCK_RAW* are supported by *AF_INET6*, *AF_INET* and *AF_UNIX*. The following statement creates a stream socket in the Internet family:

```
s = socket(AF_INET6, SOCK_STREAM, 0);
```

This call results in a stream socket with the TCP protocol providing the underlying communication.

5.6.3 Binding Local Names

A socket is created with no name. A remote process has no access to a socket until an address is bound to it.

The *bind()* call allows a process to specify the local address of the socket. This forms the set local address, local port. The *bind()* call is used as follows:

```
bind(s, name, namelen);
```

The socket handle is *s*. The bind name is a byte string that is interpreted by the supporting protocol(s). Internet family names comprise of an Internet address and port number.

This example demonstrates binding an Internet address:

```
#include <sys/types.h>
#include <netinet/in.h>
...
```

```
struct sockaddr_in6 sin6;
```

...

```
s = socket(AF_INET6, SOCK_STREAM, 0);  
bzero (&sin6, sizeof (sin6));  
sin6.sin6_family = AF_INET6;  
sin6.sin6_addr.s6_addr = in6addr_arg;  
sin6.sin6_port = htons(MYPORT);  
bind(s, (struct sockaddr *) &sin6, sizeof sin6);
```

5.6.4 Connection Establishment

Connection establishment is usually asymmetric, with one process acting as the client and the other as the server.

The server binds a socket to a well-known address associated with the service and blocks on its socket for a connect request. An unrelated process can then connect to the server.

The client requests services from the server by starting a connection to the server's socket. On the client side, the *connect()* call initiates a connection. In the Internet family, this might appear as:

```
struct sockaddr_in6 server;  
  
...  
  
connect(s, (struct sockaddr *)&server, sizeof server);
```

If the client's socket is unbound at the time of the connect call, the system automatically selects and binds a name to the socket. This is the typical means that local addresses are bound to a socket on the client side.

To receive a client's connection, a server must perform two steps after binding its socket. The first is to specify how many connection requests can be queued. The second step is to accept a connection:

```
struct sockaddr_in6 source;  
  
...  
  
listen(s, 10);          /* Allow queue of 10 connections */  
sourcelen = sizeof(source);
```

Space for learners

```
newsock = accept(s, (struct sockaddr *) &source, &source);
```

The socket handle *s* is the socket bound to the address to which the connection request is directed.

The second parameter of *listen()* refers to the maximum number of outstanding connections that might be queued.

source is a structure that is filled with the address of the client. A NULL pointer might be passed.

sourceLen is the length of the structure.

accept() returns a new socket descriptor that is connected to the requesting client. The value of *sourceLen* is changed to the actual size of the address.

A server cannot specify that it receives connections only from specific addresses. The server can check the from address returned by *accept()* and close a connection with an undesirable client. A server can accept connections on more than one socket, or avoid blocking on the accept call.

5.6.5 Data Transfer

You can send or receive a message with the normal *read()* and *write()* interfaces:

```
write(s, buf, sizeofbuf);
```

```
read(s, buf, sizeofbuf);
```

Or the calls *send()* and *recv()* can be used:

```
send(s, buf, sizeofbuf, flags);
```

```
recv(s, buf, sizeofbuf, flags);
```

send() and *recv()* are very similar to *read()* and *write()*, but the flags argument is important.

The flags, defined in *sys/socket.h*, can be specified as a nonzero value if one or more of the following is required:

- **MSG_OOB**: It is used to send and receive out-of-band data. Out-of-band data is specific to stream sockets.
- **MSG_PEEK**: It looks at data without reading. When **MSG_PEEK** is specified with a *recv()* call, any data present

Space for learners

is returned to the user but treated as still unread. The next *read()* or *recv()* call on the socket returns the same data.

- **MSG_DONTROUTE**: It is used to send data without routing packets. It is applied to the outgoing packets is currently used only by the routing table management process and is unlikely to be interesting to most users.

5.6.6 Closing Sockets

A *SOCK_STREAM* socket can be discarded by a *close()* function call. If data is queued to a socket that promises consistent delivery after a *close()*, the protocol continues to attempt to transfer the data. If the data is still undelivered after an arbitrary period, it is discarded.

A *shutdown()* closes *SOCK_STREAM* sockets gracefully. Both processes can admit that they are no longer transfer data packets. This call has the form:

shutdown(s, type);

Where *type* is defined as:

0: Disallows further receives

1: Disallows further sends

2: Disallows both further sends and receives

The following figure 5.6 illustrates initiating and accepting a Connection-Oriented Communication Using Stream Sockets.

Space for learners

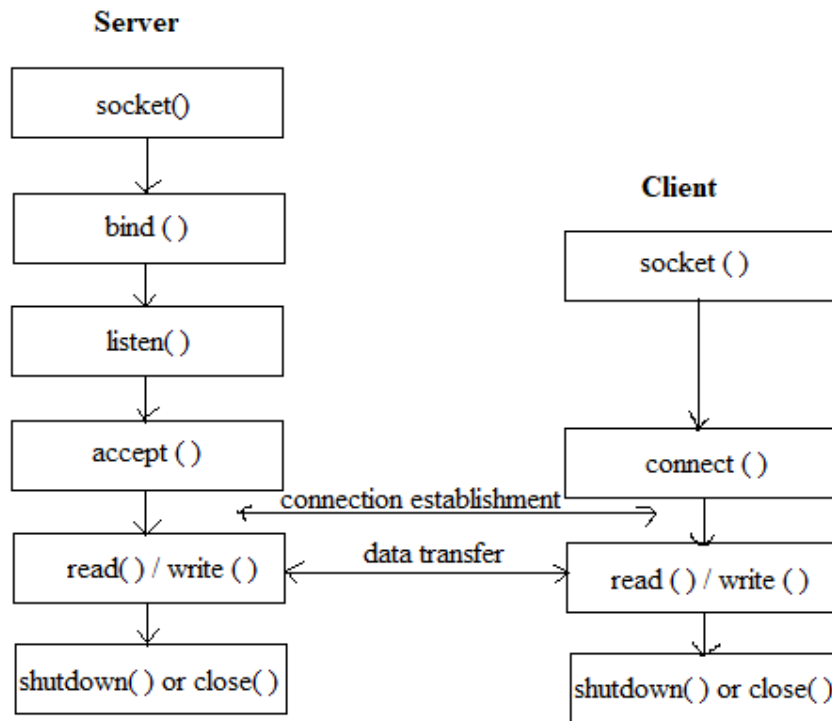

Figure 5.6 Communication using socket

5.7 REMOTE PROCEDURE CALL (RPC)

A common pattern of communication used by client/server application is the request/reply message transaction: A client sends a request message to a server, and the server replies with a message, with the client suspending execution to wait for the reply. The following figure 5.7 demonstrates the basic interaction between the client and server in RPC.

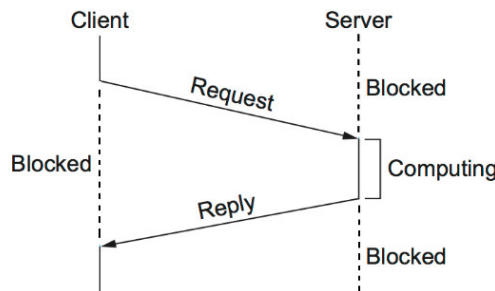

Figure 5.7: Interaction between client and server in RPC

UDP and TCP do not match the request/reply paradigm perfectly. Hence there is a requirement of another transport protocol i.e., the RPC which more closely matches the needs of an application involved in a request/reply message exchange. A complete RPC mechanism comprises of two major components:

- A protocol to manage the messages sent between the client and the server processes.
- A compiler, known as stub, to package the arguments into a request message on the client machine and then to interpret this message back into the arguments on the server machine, and similarly with the return value.

First, the client calls a local stub for the process, passing it the arguments required by the process. This stub hides the fact that the procedure is remote by translating the arguments into a request message and then invoking an RPC protocol to send the request message to the server.

At the server, the RPC protocol delivers the request message to the server stub, which renders it into the arguments to the procedure and then calls the local procedure. After the server procedure completes, it returns in a reply message which is transferred back to the client by the RPC protocol of the server.

The RPC protocol on the client passes this message up to the client stub, which decodes it into a return value and transfers the value to the client program.

The following figure 5.8 depicts the complete RPC mechanism.

Space for learners

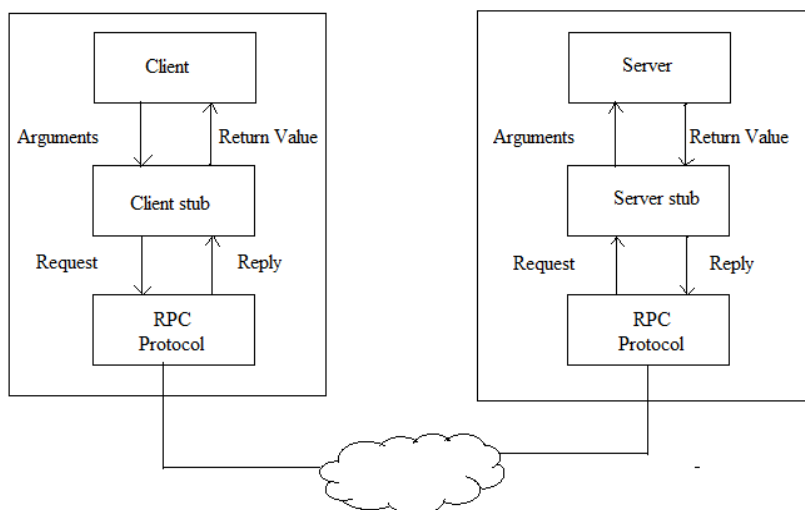

Figure 5.8: RPC Mechanism

Space for learners

5.8 SUMMING UP

In this unit, we discussed the two transport layer protocols TCP and UDP in detail. We had a close look at the UDP and TCP header formats, TCP connection establishment, TCP flow control, TCP congestion handling mechanism and finally socket interface and remote procedure call. Both protocols, TCP and UDP, deliver data between the Application Layer and the Internet Layer.

UDP is an example of a transport protocol, which provides minimum facility i.e., low-overhead, connectionless datagram delivery service with no control, no connection establishment, no acknowledgement and no congestion handling feature. Therefore, if the application is to be designed around the UDP, then such features have to be supported in the application itself. On the other hand, TCP provides several features such as reliability, flow control, congestion control, connection establishment to the various application services. Applications programmers can pick whichever service is more suitable for their specific applications.

5.9 ANSWER TO CHECK YOUR PROGRESS

1.1 a) Network Layer

1.2 c) TCP and UDP

2.1 a) all UDP packets are treated independently by transport layer

2.2 a) 8 bytes

2.3 b) checksum

3.1 It depends on the type of an application. TCP provide a connection-oriented, reliable service (extra overheads). Stream means that the connection is treated as stream of bytes. The user application does not need to package data in individual datagrams. Reliable means that every transmission of data is acknowledged by the receiver. UDP offers minimum datagram delivery service.

3.2 d) increases exponentially

3.3 d) all of the above

3.4 a) Flow control

3.5 c) 20 and 60 bytes

3.6b) Three-Way Handshaking

Space for learners

5.10 MODEL QUESTIONS

- 1) What are the functions of transport layer?
- 2) Explain the main idea of UDP? Explain the UDP datagram format in detail.
- 3) What are the differences between TCP and UDP services? Explain the TCP segment structure in detail
- 4) Is there any difference between flow control and congestion control? What is the basic mechanism at the transport layer to handle flow control problem?
- 5) What do you mean by congestion control? Discuss a congestion control algorithm used in transport layer.
- 6) Discuss advantages and disadvantages of TCP and UDP.
- 7) What is socket. Briefly explain about the different types of sockets available.
- 8) Briefly explain the communication mechanism between server and client using socket interface.

- 9) What is Remote Procedure Call (RPC)? Briefly discuss the mechanism involved with RPC
- 10) Differentiate TCP and UDP. Why does DNS use UDP and not TCP?

Space for learners

5.11 REFERENCES AND SUGGESTED READINGS

1. *Computer Networks*, A.S Tanebaum, 4th Edition, PHI, New Delhi, 2003.
2. *Computer Networking - A top down approach featuring the Internet*, J.F. Kurose & K.W. Ross, Pearson Edition, New Delhi, 2003.
3. *Data and Computer Communication*, William Stallings, 6th Edition, Pearson Education, New Delhi. 2002.
4. *Communications Networks*, Leon Garcia, and Widjaja, Tata McGraw Hill,
5. https://www.cs.ait.ac.th/~on/O/oreilly/tcpip/tcpip/ch01_06.htm
6. <https://www.sciencedirect.com/topics/computer-science/transport-layer-protocol>
7. <https://www.geeksforgeeks.org/>
8. <https://www.javatpoint.com/>
9. <https://docs.oracle.com/cd/E19455-01/806-1017/6jab5di2e/index.html>
10. <https://book.systemsapproach.org/e2e/rpc.html>
11. <https://www.coursehero.com/>

UNIT 6: APPLICATION LAYER

Space for learners

Unit Structure:

- 6.1 Introduction
- 6.2 Unit Objectives
- 6.3 SNMP
 - 6.3.1 SNMP Introduction
 - 6.3.2 SNMP Managers and Agents
- 6.4 World Wide Web (WWW)
 - 6.4.1 Introduction
 - 6.4.2 Architecture of Web
 - 6.4.3 Web Documents
- 6.5 Hyper Text Transfer Protocol (HTTP)
 - 6.5.1 HTTP Request
 - 6.5.2 HTTP Response or Status
 - 6.5.3 Persistent and Non-Persistent Connection
 - 6.5.4 Proxy Server
- 6.6 File Transfer Protocol (FTP)
 - 6.6.1 File Type
 - 6.6.2 Data Structure
 - 6.6.3 Transmission Mode
- 6.7 Domain Name System (DNS)
 - 6.7.1 Domain Name Space
 - 6.7.2 DNS in The Internet
 - 6.7.3 Resolution
 - 6.7.4 DNS Messages
- 6.8 Network File System (NFS)
 - 6.8.1 Versions of NFS
- 6.9 Remote Procedure Call (RPC)
 - 6.9.1 How RPC Works
- 6.10 Electronic Mail (E-Mail)
 - 6.10.1 Components of E-Mail
 - 6.10.2 SMTP
 - 6.10.3 POP and IMAP
- 6.11 Summing Up
- 6.12 Answers to Check Your Progress
- 6.13 Possible Questions
- 6.14 References and Suggested Readings

6.1 INTRODUCTION

In networking, the standard models such as TCP/IP and OSI both use the same term for their respective highest level layer, i.e., Application Layer. The Application Layer provides user interfaces and support for services such as electronic mail, remote file access and transfer, shared database management, surfing the World Wide Web, network management and other types of distributed information services. It is the layer that the users interact with. The Application Layer is responsible for providing different web services to the user.

6.2 UNIT OBJECTIVES

This unit basically includes some Application Layer's applications and protocols. In this unit, you will be able to learn:

- SNMP its components and versions.
- WWW and HTTP protocol
- FTP protocol
- DNS and the role of name servers
- NFS and RPC
- E-Mail and its components.

6.3 SNMP (SIMPLE NETWORK MANAGEMENT PROTOCOL)

6.3.1 Introduction

The Simple Network Management Protocol (SNMP) is a framework (as presented in Figure 6.1) for managing devices in internet using the TCPI/IP protocol suite. It provides a set of fundamental operations for monitoring and maintaining an internet. SNMP uses the concept of managers and agents. That is, a manager, usually a host, controls and monitors a set of agents, usually routers. SNMP uses port number 161/162 to monitor the network, keeps tract of the changes to the network, determines the status of network devices in

Space for learners

real time, detects network faults and sometimes uses to configure remote devices. SNMP uses User Datagram Protocol (UDP) as the transport layer protocol for passing data between managers and agents.

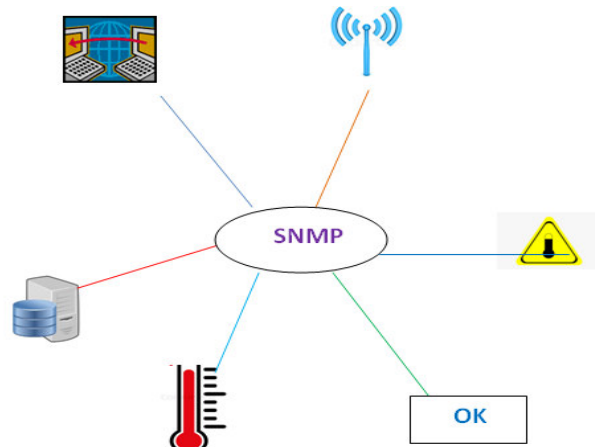

Figure 6.1 Framework of SNMP

STOP TO CONSIDER

SNMP is a framework for managing devices in an internet using the TCP/IP protocol suite. SNMP uses port number 161/162 to monitor the network, keep track of the changes to the network, determine the status of network devices in real time, detect network faults and sometimes used to configure remote devices.

6.3.2 What are Managers and Agents?

In SNMP, concept of the manager and the agent are very important. A manager is a host that runs the SNMP client program. Again, an agent is a router that runs the SNMP server program. When there is a simple interaction between a manager and an agent, management of the internet is achieved. Both manager and agent perform different task. Normally agent is used to keep the information in a database where the manager is used to access the values in the database. Interaction between agent and manager can be discussed considering a simple example: suppose a router can store the

Space for learners

appropriate variable such as number the packets received and forwarded while the manager can compare those stored variables to determine whether the router is congested or not. Figure 6.2 shows how SNMP manager and agent work.

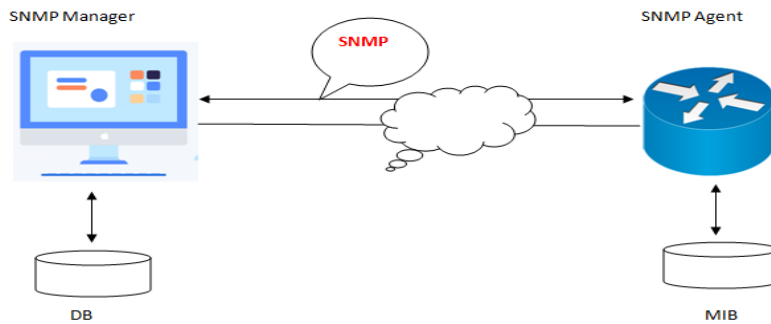

Figure 6.2 SNMP Manager/Agent

Agents can also contribute to the management process. A server program on the agent checks the environment, if something goes wrong, the agent sends a warning message to the manager. Details about MIB will be discussed in the Network Management chapter (Chapter-7).

CHECK YOUR PROGRESS

- Q1. SNMP uses TCP. (State True or False)
- Q2. Define Manager and Agent concept used in SNMP.

6.4 WORLD WIDE WEB (WWW)

6.4.1 Introduction

The World Wide Web (W3) or the Web is an architectural framework for accessing linked content spread over millions of machines all over the Internet or it is the repository of information linked together from points all over the world. In the web, HTTP (Hypertext Transfer Protocol) is used to connect all resources and user. The basic features of the web include flexibility, portability and user friendly. WWW was started with the basic idea to merge

Space for learners

the evolving technologies of computers, networks and hypertext into a powerful and easy to use global information system. The WWW concept was first introduced by Tim Berners Lee (as shown in figure 6.3), a CERN scientist in 1989.



Figure 6.3: Tim Berners Lee

6.4.2 Architecture of Web

As shown in figure 6.4, a client is associated with many sites. Again, each site holds one or more web documents, which are referred to as Web pages. Each Web page can contain a link to other pages in the same site or at other sites. The users can retrieve and view these web pages by using browsers. The figure 6.4 shows that if a client needs to see some information that it knows belongs to site A, then client sends a request through its browser, using a program that is designed to fetch Web documents. In that client request, among other information, it includes the address of the sites and the Web pages, which is called as the URL. At site A, the server finds the required web document and sends it to the intended client. When the user receives the document and views it, it finds some references to other web documents which are located at site B. The reference has the URL for the new site B. If the user is also interested in viewing this document, then the client sends another request to the new site B, and the new page is retrieved from that site.

Space for learners

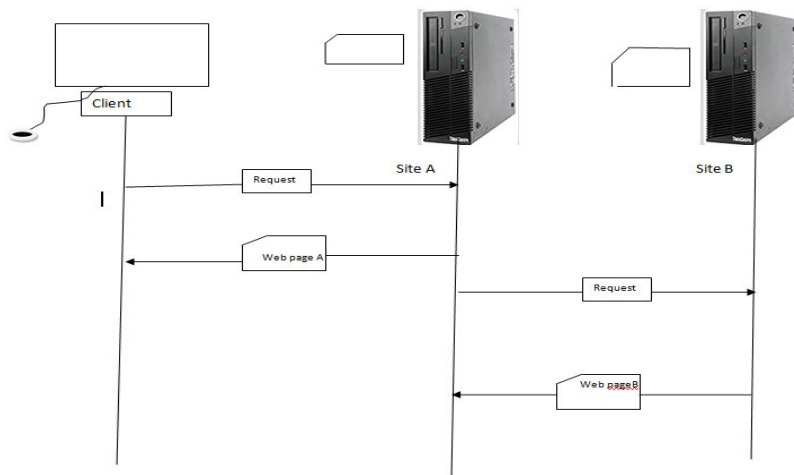

Figure 6.4: Architecture of WWW

Client (Web Browser):

The web browser or the browser is an application software used to interact the user with the content and data on the web. When any user sends request for some content, the browser fetches the particular content from a web server and then only displays the content-based webpage on the user screen. In 1990, Tim Berners-Lee, the british scientist, first ever introduced a browser known as *WorldWideWeb* which was later renamed Nexus. Later on, a group of web browsers were introduced among them Mozilla Firefox, Internet Explorer and Google Chrome are the commonly used web browsers across the globe. Each browser consists of different parts. Normally a web browser has three common parts which are presented in figure 6.5:

- i. A controller
- ii. Client protocol and
- iii. Interpreter

Space for learners

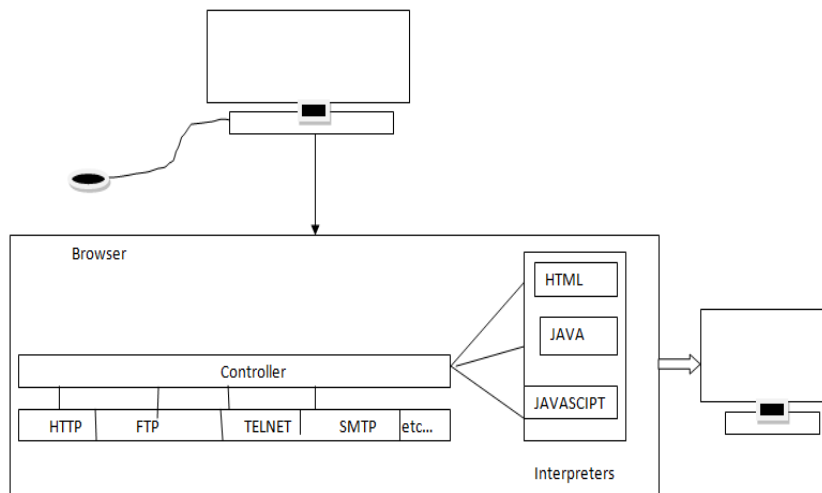

Figure 6.5: Browser

A controller receives input from input devices such as mouse or keyboard and uses the client programs to access the document from the web. When the document has been accessed, the controller uses any interpreters to display the required document on the user's screen. The client can use protocol such as FTP or HTTP. Depending on the type of the document, interpreter can be HTML, JavaScript or Java.

Server:

Web server is the part of Internet where all web pages are stored. When a client sends a request for a particular document to the server, on arriving the request corresponding document is sent to the client from the server. To improve efficiency, web servers normally store requested files in cache memory where memory is faster to access than disk. Multithreading and multiprocessing are also used to improve the efficiency of the server, in that case a server can answer more than one client request at same time. Figure 6.6 presents how a web server communicates with a web browser.

Space for learners

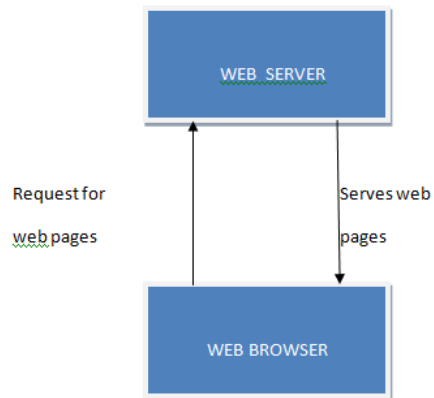

Figure 6.6: Web server communicates with web browser

Uniform Resource Locator (URL):

URL is known as a web address, a unique identifier used to locate a resource on the internet composed of multiple parts. In 1994, URL was first introduced as a part of the Uniform Resource Identifier (URI). URLs are the subset of URIs and are used to address the electronic resources. The syntax of URL is similar to mail address, which contain several fields.

The URL syntax:

The following syntax is used in URL

scheme: //host:port/path?query-string#fragment-id

A URL consists of the following:

- i. Scheme name: It identifies the protocol to be used to access the e-resource on the web. The scheme names followed by a colon and two slashes (: //). Commonly used protocols are http: //, https: //, ftp: // etc.
- ii. Host name: It identifies the host where resource is located. Normally, a host name is a name of the domain.
- iii. Port Number: Port no. tells the server what service is being requested as servers often deliver more than one type of service. For example, HTTP runs by default port 80.
- iv. Path: It defines the specific resource within the host that the user wants to access.

Space for learners

- v. Query String: It contains data to be passed to server-side scripts, running on the web server. The query string preceded by a question mark (?), is a string of name and value pairs separated by ampersand (&).
- vi. Fragment identifier: The fragment identifier introduced by a hash character (#) is the optional last part of a URL for a document. The fragment identifier, if present, specifies a location within the page; browser may scroll to display that part of the page.

Space for learners

STOP TO CONSIDER

Tim Berners Lee proposed the concept of WWW in 1989. The basic features of the web include flexibility, portability and user friendly. The first web browser was World wide Web. Don't be confused with World Wide Web introduced by Tim Berners Lee. URL is known as web address, is a unique identifier used to locate a resource on the internet composed of multiple parts.

Cookies:

Cookies are alphanumeric values stored at the client by the browser. Web browser stores relevant data of previous (connection) as cookies to facilitate quick access when the user tries to establish the same search (connection) again. Now-a-days in e-commerce, looking at customer's interest, the website can construct personal profiles for all users and can give personal look to its home page when a specific user accesses the previously searched website. The following figure 6.7 presents the role of cookies.

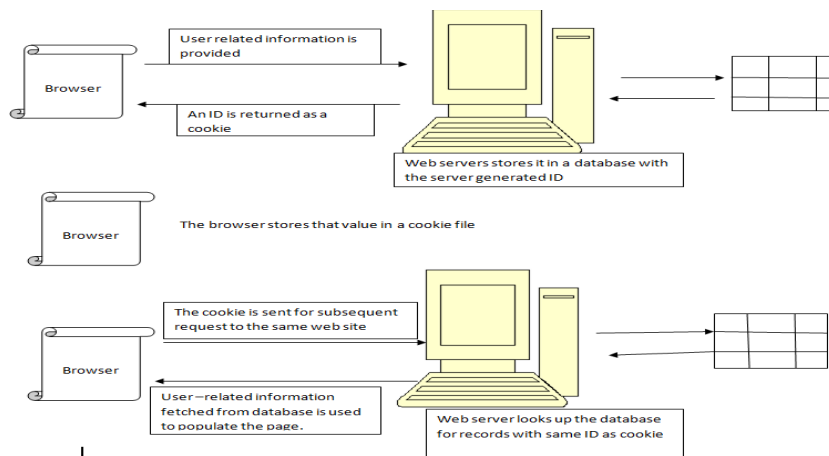

Figure 6.7: The role of cookies

Cookies have some disadvantages from the point of security, any intruder can easily open these files and can view information. Also, all sites that collect information from cookies are legitimate as some of them may be malicious and can be used for the purpose of hacking. Again, cookies can store only few kb of information, mostly are up-to 4kb only. Browser assigns some restriction on cookies also, for example except internet explorer, the browsers allow only up-to 20 cookies for a single website.

CHECK YOUR PROGRESS

- Q3. Define URL?
- Q4. World Wide Web is the first web browser. (State True or False.)
- Q5. State basic features of WWW.
- Q6. What are cookies?

6.4.3 Web Documents

A web document is hypertext document that is normally written by using Hypertext Markup language (HTML). HTML is used to create web pages. HTML can describe the structure of the web pages. HTML consists of series of elements called tags and these elements tell the web browser how to display the content of the web page. The markup language allows developer to embed formatting instructions in the file itself. The required instructions are included

Space for learners

with the text. And in this way, any browser can read the instructions and format the text according to the specific workstations.

Only ASCII characters for both the main text and formatting instructions are used in HTML. Every computer receives the whole web document as an ASCII document. HTML program consists of two parts:

- The head and
- The body

The first section of web page is head where the head contains the title of the web page and other parameters. The contents of a web page lie in the body section, which includes text and the required tags. In HTML, the tag defines the actual appearance of the web documents such as color, heading size and other effects also. The `<html>...</html>` is the root element of the HTML based web page. An HTML element uses the following syntax:

`<tag name> contents </tag name>`

HTML tags are not case sensitive i.e either upper, lower or proper case can be used for tags. Except few tags, all other tags have one or multiple attributes. An attribute if present in document is followed by an equal sign (=) and the value of the attribute. The browser takes the decision about the structure of the text based on the tags, which are embedded into the text.

Web documents can be broadly classified into the following categories:

- Static
- Dynamic and
- Active

Static web page:

The content of static page cannot be changed by client, the client can get only a copy of the document. When the file is created, the contents are determined i.e static documents are fixed-content documents that are created and stored in a web server. Of course, the content in the web server can be changed, but not by the client. When a client accesses the document, a copy of the document is sent. The client can use a browsing program to display the document. A static web page is shown in figure 6.8.

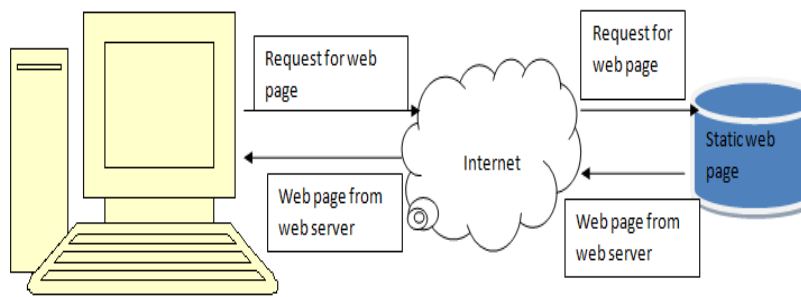

Figure 6.8: Static HTML page

Dynamic web page:

A dynamic web page can display different content and has user interaction by making use of advanced programming (Scripting languages, Ajax technology) and databases in addition to HTML.

In dynamic web pages, scripting languages are used with HTML for creating a run time environment. In scripting languages, step by step compilation is not required rather they are interpreted. In dynamic web pages server side and client side dynamic pages are available. The server side scripting are usually used in back-end of websites and user does not get access to view. In server side scripting, all responses can be customized only based on the user requirements. Commonly used languages in server side include PHP, ASP, ASP.NET, Perl, J2EE, Python, Ruby. Again, client-side script is executed in client's side also called front end. Client side scripting are normally used for page navigation, formatting and data validation etc (used to make web pages interactive). Scripts are used to create cookies. Client side generally uses CSS, HTML, JavaScript, Adobe Flex etc languages.

Active documents:

In client server architecture for many applications sometimes a program or a script is to be run at the client site. These types of documents are called active documents. Generally, an active document consists of a program that the server sends to the browser and the browser must run that locally. When it is run locally, the program within active document can interact with the user and change the output continuously. Active documents can be explained with the help of an example, say user wants to run a program that creates animated graphics or multimedia on the screen or a program that interact with the user, then the program surely runs at the client

Space for learners

site where the animation or interaction takes place. In that case, when the browser requests an active document, the server sends a copy of the active document or a script and the document is run at the browser.

STOP TO CONSIDER

Web documents are of three categories: static, dynamic and active document. Scripts are used to create cookies. Client side generally uses languages like CSS, HTML, JavaScript, Adobe Flex etc.

CHECK YOUR PROGRESS

Q7. What do you mean by static web page?

Q8. HTML tags are case sensitive. (State True or False)

Q9. What is markup language?

Q10. What are the basic sections of HTML?

6.5 HYPER TEXT TRANSFER PROTOCOL (HTTP)

HTTP is an application layer protocol used basically to access data on the World Wide Web. It is a request–response protocol that uses the services of TCP. It provides an interface to the user to transfer resources in terms of request–response message using TCP protocol. In HTTP, before transferring original message using TCP protocol, a connection is established between the client and the server. It is somehow similar to FTP as it also transfers files but is simpler because HTTP uses only one TCP connection. In HTTP, there is no separate connection for control operation, only data are transferred between the client and the server. Well-known port 80 is used by HTTP. Though HTTP uses the services of TCP, but it is itself a stateless protocol. HTTP request and response technique is depicted in Figure 6.9.

Space for learners

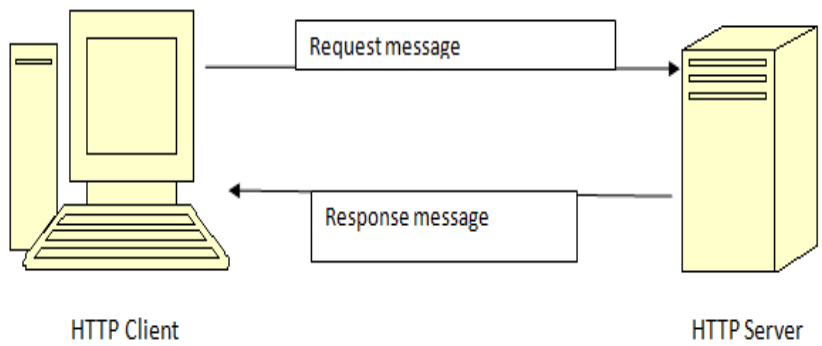

Figure 6.9: HTTP request and response

When a HTTP server finds some request from client side, it accepts the request and then HTTP client sends a request for resource to the server. On receiving the request from the client, the server processes the request, performs the desired task and sends response back to the client. After that, HTTP server closes the TCP connection and the HTTP client receives the responses from the server containing the desired information and processes it.

6.5.1 Request

A request is sent by a client to the web server. It consists of several parts as shown below:

Request line
Header
Empty line
Body

6.5.1.1 Request line in HTTP

In HTTP, a request line consists of the three sections: request type, URL and HTTP versions which are shown in figure 6.10.

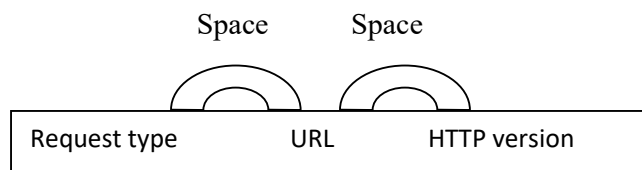

Figure 6.10: Sections of request line

Space for learners

Request type:

It indicates the type of request; a client wants to send. They are also called methods. A method sends a message in the form a request or a command to the server. Request and command both are different in that sense that request messages are used to retrieve data from the server and a command message tells the server to do the specific task. Commonly used some of the methods are as follows:

GET: Most widely used method in WWW is GET. Using this method, a client can retrieve a resource from the server.

PUT: This method is used to upload a new resource or replace an existing document in the web.

HEAD: This method is used when the client wants to know the header information about a resource but not the resource content. Here, address of the document is defined by the URL.

COPY: The method COPY is used to copy a file from a location to another location.

DELETE: This method is used to delete a web document from the server.

TRACE: The TRACE method is used to instruct the web server to echo the request back to the client i.e., it is used as loop-back.

6.5.2 Response or Status

Responses are sent by the server to the client. A response consists of four parts as presented in the following.

Status line
Header
Empty line
Body

6.5.2.1 Status Line

Status line contains HTTP version, status code and status phrase as presented in figure 6.11.

Version: Current version of HTTP is 1.1.

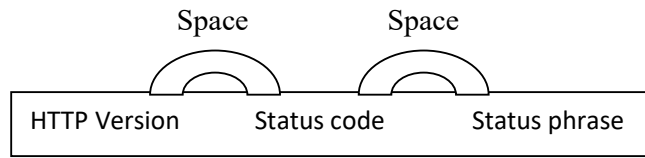

Figure 6.11: HTTP response status line

Status code:

In HTTP, a three-digit code is used which indicates the responses or status. Table 6.1 presents various HTTP status code. The status code has five categories depending on their functionalities. The categories can be discussed as follows:

- 1xx series:- This category of status code represents provisional responses.
- 2xx:- This category of status code represents that the client’s requests are accepted successfully.
- 3xx:- This category of status code represents that some additional actions must be taken by client to complete the request.
- 4xx:- This category of status code represents that client request has some error and so it cannot be fulfilled.
- 5xx:- This category of status code represents server error i.e the server encountered some error and hence the request cannot be completed at this time.

Table 6.1: HTTP status code

Status code	Status phrase	Description
1xx category-informational		
100	continue	The initial part of the request has been received by the server, and the client may proceed further.
101	Switching	The server switches the protocol while receiving a request from the client to do the same.
2xx category-Success		

Space for learners

200	OK	The request is successful
201	Created	A new URL is created.
202	Accepted	The request is accepted, but it is not immediately acted upon.
204	No content	There is no content in the body.
3xx category-Redirection		
301	Moved permanently	The resource is no longer used by the server
302	Moved temporarily	The requested URL has moved temporarily
303	See other	The method may be wrong.
4xx category-Client Error		
400	Bad request	There is a syntax error in the request.
401	Unauthorized	The request lacks proper authorization
403	Forbidden	Service is denied.
404	Not found	The document is not found.
5xx category-Server Error		
500	Internal server error	Indicates a error message, server face some problem.
501	Not implemented	Unable to fulfill the request.
503	Service unavailable	The service is temporarily unavailable, due to maintenance or other issue may be arisen.

Space for learners

6.5.2.2 Header

Header is a very important part in HTTP. In both request message and in response message, header is important. The header shares additional information between the client and the server of a particular request. For example, a client may want to accept video in a special format, that time the server can send extra information about the video. Generally, a header can consist of one or more header lines. A header line contains a header name, a space and a header value, which is shown in figure 6.12.

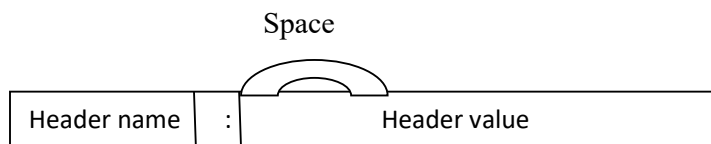

Figure 6.12: HTTP Header Format

A header name is not case sensitive; but the header value may be case sensitive.

HTTP Header line belongs to one of four categories:

- General header
- Request header
- Response header and
- Entity header.

General header:

In HTTP, some general headers are present in both request message and response message but with different meaning. Table 6.2 presents the list of HTTP general header.

Table 6.2: HTTP General header

Header	Description
Cache-control	Specifies information about caching, whether caching should be used or not.
Connection	Shows and specifies whether the connection should be closed or not
Date	Shows the current date and time

Request header:

As the name suggest, the request header is present only in the request message. Request header specifies the client's information such as client's configuration and the client's preferred document format etc. HTTP request header list is presented in Table 6.3.

Table 6.3: HTTP request header

Header	Description
Accept	It Shows the format of the medium the client can accept.
From	Shows the e-mail address of the user.
User-agent	Identifies the client program.

Response header:

As request header is present only in request message, similarly response header is present only in the response message. It contains

Space for learners

the data about the web server and the data that are being sent. HTTP response header is depicted in Table 6.4.

Table 6.4: HTTP response header

Header	Description
Accept-rang	Shows the partial range type the server support.
Age	Shows the age of the document
Server	Shows the information of the server such as server name and version number.

Entity header:

Entity header is present in both request message and response message and it contains the information about the body of the document. Table 6.5 describes different entity header in the following.

Table 6.5 HTTP Entity header

Header	Description
Allow	Lists of valid methods that can be used on a URL.
Content-language	Specifies the language of the content.
Etag	An identifier for entity tag.

6.5.2.3 Body

The body is present in a request or response message. Usually, it contains the document to be sent or received by the user.

6.5.3 Persistent Versus Nonpersistent Connection

The persistent connection is the default version 1.1. Again, HTTP prior version of 1.1 is specified as nonpersistent connection.

Persistent Connection:

Space for learners

As mentioned above, HTTP version 1.1 specifies a persistent connection by default. After sending a response in persistent connection, the server leaves the connection open for more requests. The server also can close the opened connection at the request of a client if a time out has been reached.

Nonpersistent Connection:

In nonpersistent connection, after sending a response the connection is terminated. So, in nonpersistent connection, one TCP connection is established for each request/response.

6.5.4 Proxy Server

A proxy is an application program or a computer system that behaves like an intermediary between the clients looking for services and servers. HTTP protocol supports proxy server. It keeps copies of responses to recent requests. In HTTP, the HTTP client sends a request to the proxy server; on receiving the request the proxy checks it in the cache. If the responses are available, it responses. Otherwise, the proxy server sends the request to the corresponding server. In that case, incoming responses are sent to the proxy server and stored for future request from other clients. With the use of proxy server, the load of the original server can be reduced which can decrease traffic and improves latency. To use proxy in client's machine, the client must be configured to access the proxy instead of the original server.

STOP TO CONSIDER

Well-known port 80 is used by HTTP. HTTP uses the services of TCP but itself it is a stateless protocol. In HTTP, request is sent by the client to the server using different methods like GET, PUT, HEAD, COPY etc. Responses are sent by the server to the client. Current version of HTTP IS 1.1. HTTP Version 1.1 specifies a persistent connection. Proxy server can decrease the load of the original server and decrease traffic.

Space for learners

CHECK YOUR PROGRESS

Q11.HTTP status 200 code defines “OK”? (State True or False)

Q12.HTTP uses well known port _____ (Fill in the blank)

Q13.Why proxy server is used?

Space for learners

6.6 FILE TRANSFER PROTOCOL (FTP)

FTP is an application layer standard protocol for transferring files from a server to a client or from a host to another. During transfer of file from one system to another, there may be several issues: Consider two systems may use different ways to represent text and data or may use different file name conventions. Sometimes two systems may have different directory structures, so all these types of problems during file transfer have been solved by FTP. FTP also follows client/server mechanism but it somehow different from other client/server application. In FTP, it establishes two connections between the connecting systems. One connection is for data transfer and the other one for the control information as shown in figure 6.12. Due to this separation of connection, FTP services are considered more efficient.

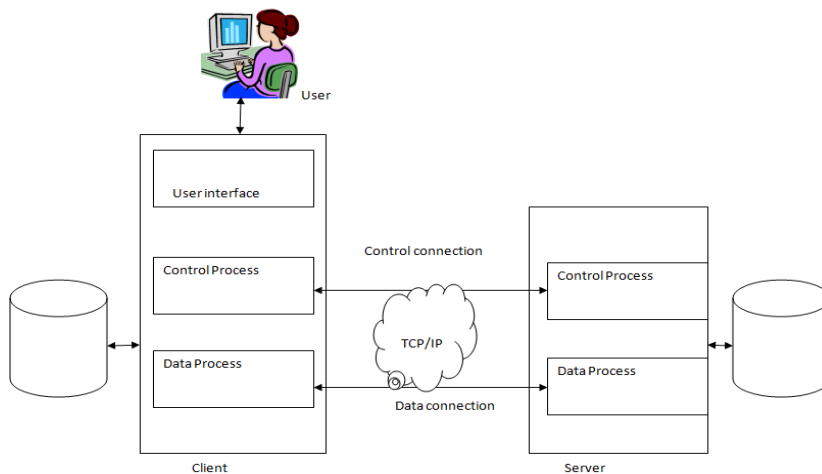

Figure 6.12: FTP connections

Compared to control connection, data connection is more complex as variety of data types need to be transferred. FTP uses all the

services of TCP and it needs two TCP connections. For control connection, FTP uses the well-known port 21 and for data connection it uses port 20.

In FTP, data connection is opened each time commands are executed that involves transferring of files and after transferring, it is closed. But the control connection remains connected during the entire interactive FTP session. In FTP, while control connection is opened, the data connection can be opened or may be closed several times if multiple files are transferred. Like SMTP, FTP also uses the same approach to communicate across the control connection i.e. it uses the 7-bit ASCII character set. Communication between systems achieved through command and responses.

In data connection, the client must provide some information such as the types of the transferred file, the structure of the data and the mode of transmission. Again, before data connection preparation should be done through control connection.

6.6.1 File Type

Across data connection FTP can transfer one of the following types of files: an EBCDIC file, image file or an ASCII file. The default format for transferring text file is ASCII. In ASCII, each character is encoded into 7-bit ASCII form. In both sides i.e. in the sender side, the original file representation is converted into ASCII character and in the receiver side, the receiver transform ASCII characters into its original representation. But if one or both systems of the connection use EBCDIC encoding format then the file can be transferred using EBCDIC encoding. Again, for binary files, image file is the default format. In that case, the file is sent as a stream of binary bits without any interpretation or encoding.

6.6.2 Data Structure

In FTP, three types of interpretations about the structure of the data are used:

- File structure,
- Record structure, and
- Page structure.

Space for learners

In the file structure format, the file is a continuous stream of bytes. The record structure can be used only with text files and the file is divided into records. In the page structure format, the file is divided into pages. The divided pages can be stored and accessed randomly or sequentially.

Space for learners

6.6.3 Transmission Mode

In FTP, three transmission modes are employed to transfer files: stream mode, block mode, and compressed mode. The default mode is stream mode. In this mode, Data are delivered from FTP to TCP as a continuous stream of bytes. TCP is responsible for dividing data into segments of appropriate size. In block mode, data is delivered from FTP to TCP in blocks. Again, in the compressed mode, if the file is big, the data is sent in compressed form. The compression method normally used is run-length encoding.

Point to be remembered that to use FTP, a user must need a user account and a password on the remote server. But some sites have a set of files available for public access, to enable anonymous FTP. For access any files in those sites, user password and account may not be required. Instead, the user can use anonymous as the user name and guest as the password but user access to the system is very limited.

STOP TO CONSIDER

FTP is an application layer protocol used to transfer files. It has two connections, one for control connection and another one for data connection. Port 20 is used for data connection and port 21 is used for control connection. In FTP, default mode of data transfer is stream mode. Moreover, it has block and compressed mode.

CHECK YOUR PROGRESS

- Q14. Write down the purpose of using FTP protocol.
Q15. Discuss the different connections available in FTP.

6.7 DOMAIN NAME SERVICE (DNS)

In application layer, various protocols are used; some are related to file transfer, some for email, some for remote login and network management. Also, there is a name management or name resolution protocol for name resolution which is known as DNS. In the application layer, several applications are used that follow the client/server model. It is a sort of a global database for internet addressing, mail and other information. So, why suddenly we require this? Now you see, whenever you want to communicate one data packet from one to another, what we require? We require primarily the IP address of the destination. So, specially when internetworking is done, the IP address of the destination is required. Now, remembering IP address is a tedious job for the user. If anyone wants to browse gauhati university website, he/she can type “www.gauhati.ac.in” and instead of this, he wants to remember the IP address of “gauhati” as 192.17.3.12, it is very difficult task to remember the IP address. So, in this situation, a naming convention called DNS is introduced. The primary job of DNS is to resolving name to IP address. Subsequently, the concept of domain and sub domains are included in DNS. To understand this, let us consider Gauhati University DNS “gauuni.ac.in”. Here, gauuni is the primary domain. Again, in domain name “idol.gauhati.ac.in”, idol is called sub domain. The services offered by DNS is somehow similar to phone book for the internet as it translates human-friendly host name into IP address. Thus, DNS is called a directory service which provides a mechanism of mapping between the name of a host on the network and its numerical address.

6.7.1 Domain Name Space

In DNS, to have a hierarchical name space, a domain name space was designed in an inverted-tree structure with the root at the top. It is defined that the tree can have only 128 levels, where level 0 is the root and level 127 is the last one.

Label:

In hierarchical structure, each node in the tree has a label, maximum of 63 characters string. The root one is a null string. DNS requires that nodes that branch from the same node have different labels and it must be unique.

Space for learners

Domain name:

A full domain name in this form is a sequence of labels and they are separated by (.) dots. And one must remember that the domain names are always read from the node up to the root. Domain tree is presented in figure 6.13.

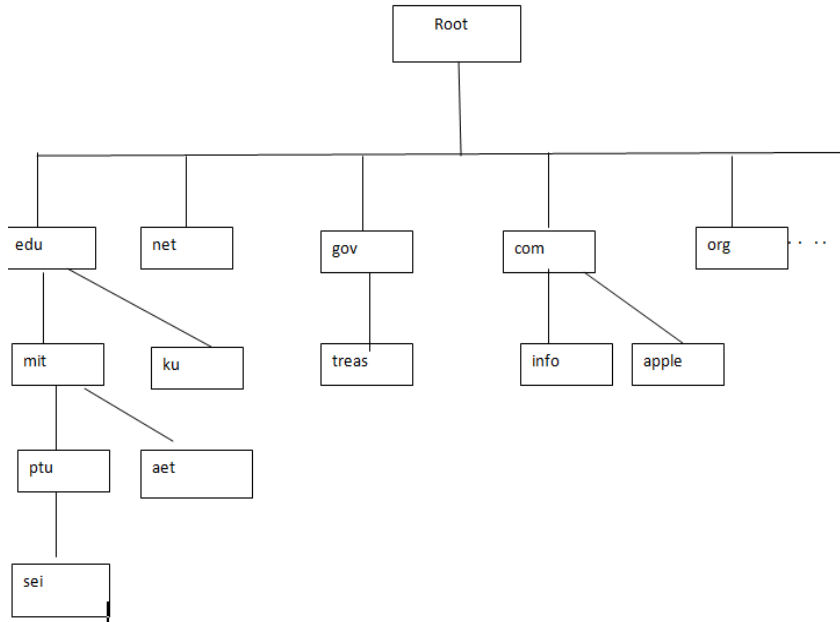

Figure 6.13: Domain Tree

Fully Qualified Domain Name (FQDN):

If a domain name contains the full name of a host, it is known as FQDN. In FQDN, a label is terminated by a null string. Generally, in FQDN it contains all labels from the most specific to the most general and it is uniquely defined the name of the host. It must be remembered that the label ends with a dot (.) indicating null.

Partially Qualified Domain Name (PQDN):

A PQDN does not reach to the root which is started from a node and it is not terminated by null string. It is used when the name to be resolved belongs to the same site as the client. Here the resolver can supply the missing part, called the suffix, to create an FQDN.

Domain

A domain can be defined as a sub tree of the domain name space. The name of the domain is the domain name of the node at the top of the sub tree. Domains are itself divided into some subdomains.

Space for learners

6.7.2 DNS in the Internet

Generic domains, country domains, and the inverse domains are three categories of domain name space which are used in internet.

Generic domain:

According to the generic behavior, generic domains define the registered host. In this category, each node in the tree defines a domain. Example of generic labels is presented in Table 6.6.

Table 6.6: Internet generic domains

Label	Description
edu	Educational institution
gov	Government institutions
net	Network support centers
org	Nonprofit organizations
mil	Military groups
com	Commercial organizations

Country Domains:

In country domains, it uses two characters of respective country abbreviations i.e in for India, uk for United Kingdom.

Inverse Domain:

The inverse domain is used in internet to map an IP address to a name. This situation is arisen when a server has received a request from a client to do a task. The server has a file that contains a list of authorized clients, only the IP address of the client is listed. The server asks its resolver to send a query to the DNS server to map an address to a name to determine if the client is on the authorized list.

6.7.3 Resolution

As already mentioned, that mapping a name to an address or an address to a name is called name-address resolution.

Resolver:

As DNS is designed for a client/server application. Hence, a host that needs to map an address to a name or a name to an address calls

Space for learners

a DNS client called a resolver. The resolver accesses the closest DNS server with a mapping request. If the server has the information, it replies the resolver; otherwise, it either refers the resolver to other servers or asks other servers to provide the information. After the resolver receives the mapping, it interprets the response to see if it is a real resolution or an error, and finally delivers the result to the process that requested it. In DNS, mapping names to addresses and addresses to names are possible.

In name to address mapping most of the time, the resolver gives a domain name to the server and requesting for corresponding address. On receiving request, the server checks the different domains (generic or country domain) to find the mapping. If the domain name is from the generic domain or from the country domain, the resolver gives a proper reply.

Mapping Names to Addresses:

Most of the time, the resolver gives a domain name to the server and asks for the corresponding address. In this case, the server checks the generic domains or the country domains to find the mapping. If the domain name is from the generic domains section, the resolver receives a domain name such as "chal.atc.jhda.edu.". The query is sent by the resolver to the local DNS server for resolution. If the local server cannot resolve the query, it either refers the resolver to other servers or asks other servers directly. If the domain name is from the country domains section, the resolver receives a domain name such as "ch.jhda.cu.ca.us.". The procedure is the same.

Mapping Addresses to Names:

A client can send an IP address to a server to be mapped to a domain name. As mentioned before, this is called a PTR query. To answer queries of this kind, DNS uses the inverse domain. However, in the request, the IP address is reversed and the two labels in-addr and arpa are appended to create a domain acceptable by the inverse domain section. For example, if the resolver receives the IP address 132.34.45.121, the resolver first inverts the address and then adds the two labels before sending. The domain name which is sent is "121.45.34.132.in-addr.arpa." which is received by the local DNS and resolved.

Space for learners

STOP TO CONSIDER

In the Internet, the domain name space is divided into three different sections: generic domains, country domains, and the inverse domain. In DNS, mapping name to address and address to name is possible.

Space for learners

6.7.4 DNS Messages

DNS uses query and response types of messages. In query message, it has two records: a header and question records. The response message consists of a header, question records, answer records, authoritative records.

CHECK YOUR PROGRESS

Q16. In DNS, what is the label for non profitable organization?

Q17. PQDN stand for-----

6.8 NETWORK FILE SYSTEM (NFS)

This protocol was developed in 1984 for distributed file system. It is applicable for client/server platform. It enables system administrator to consolidate resources onto centralized servers on the network. In NFS, it uses Remote Procedure Calls (RPC) to route requests between the client and the server. Details discussion on RPC will done shortly. It uses TCP or UDP for accessing files and delivering data. Using this protocol, users can access the data and files remotely over the network. NFS is an open standard so any user can easily implement the protocol. NFS allows multiple computers to use the same files and everyone on the network can access the same file data. Thus, NFS service makes the physical location of the file system irrelevant to the user. If anyone wants to work with default installation of Red Hat Enterprise Linux with a firewall enables, IP tables must be configured with the default TCP port 2049.

6.8.1 Versions of NFS

Currently, there are three versions of NFS available with different features of each version. The versions are NFSv2, NFSv3 and NFSv4. It must be noted that all versions of NFS can use TCP running an IP based network. But NFSv2 and NFSv3 both can use UDP also and it provides a stateless network connection between the client and the server.

NFSv2: This version is the older version and widely used. As already mentioned, NFS v2 uses the UDP to provide a stateless network connection between the client and the server. This version is widely supported by different operating systems.

NFSv3: This version introduces several features to improve interoperability and performance. It supports safe asynchronous writes on the server which improve performance and makes response time faster. It is also more robust at error handling than the earlier v2. NFSv3 supports 64-bit file sizes and offsets and allows clients to access data more than 2GB.

NFSv4: It enhances the performances and security of the network. This version requires TCP connection.

STOP TO CONSIDER

NFSv2 and NFSv3 can use UDP but NFSv4 requires TCP connection.

CHECK YOUR PROGRESS

- Q18. What is NFS?
- Q19. What are the different versions of NFS?
- Q20. NFS uses TCP port

6.9 REMOTE PROCEDURE CALL (RPC)

Remote Procedure Call is used as a fundamental building block for implementing remote operations in a distributed system. The basic model of the RPC has been proposed by American scientist Bruce Jay Nelson in 1981. It is a request-response (client/server interaction) protocol i.e in RPC, a request message is sent by client to the remote server to execute a specified procedure with supplied

parameters. On receiving the request message from the client, the server responds to the client and the application continues its process. An important difference between a local call and remote call is that a remote call may be failed because of the unpredictable network problems which may be in server side or client side.

Space for learners

6.9.1 How RPC works

A complete RPC mechanism has mainly two components:

- i. A protocol which manages the messages sent between the client and the server processes.
- ii. A compiler which supports programming language to package the arguments into a request message on the client machine and then to translate this message again into the arguments on the server machine and with the return value.

As it is already mentioned that RPC follows client /server model. A client has a request message that the RPC translates and sends that request to the server. On receiving a request (request may be a procedure or a function call to a remote server) from a client, it sends the required response back to the client. While the server processing the call that time the client is blocked and only resume execution after the server processing is being finished. RPC has to follow a sequence of events which can be listed as follows:

Firstly, the client stub is called by the client. Then the client stub makes a system call to send the message to the remote server. From the client's operating system, the message is sent to the server. Then the message is passed to the server stub by the server operating system. Whatever the parameters are assigned, with client's message is removed from the message by the server stub and finally the server procedure is called by the server stub. Figure 6.14 depicts RPC process. RPC or Remote Procedure Call is used as a fundamental building block for implementing remote operations in a distributed system.

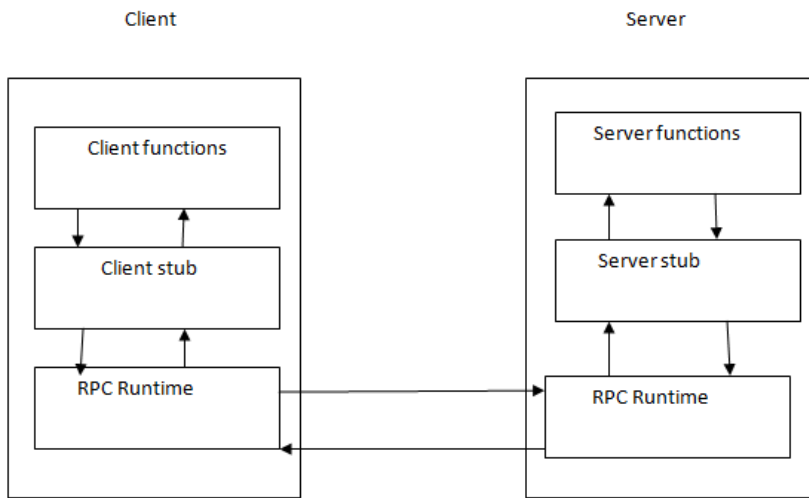

Figure 6.14 RPC process

CHECK YOUR PROGRESS

Q21. Explain RPC. How it works? .

Space for learners

6.10 E-MAIL (ELECTRONIC MAIL)

Electronic mail or e-mail is one of the most popular Internet application programs. Its architecture consists of several components and the components are discussed in the following. At the very beginning, e-mail messages were very short and only text messages were exchanged. Now a days, electronic mail is too complex and it allows not only text message instead it includes text, image, audio and video. It integrates that facility also where more than one recipient can view the message at the same time. So, here we study the architecture of an e-mail including its components and then protocols that implement this. In an e-mail system, three basic components are included: user agent, message transfer and message access agent.

6.10.1 Components of e-mail

The e mail application contains three components:

- i. The first one is known as user agent. User agent is what users responsible for interacting with to send and receive mails.

ii. The second one is known as message transfer agent which navigates the mails to their recipients.

iii. The third and last component of the email is the mail itself.

Following figure 6.15 shows the entire mailing process and different components of e-mail application.

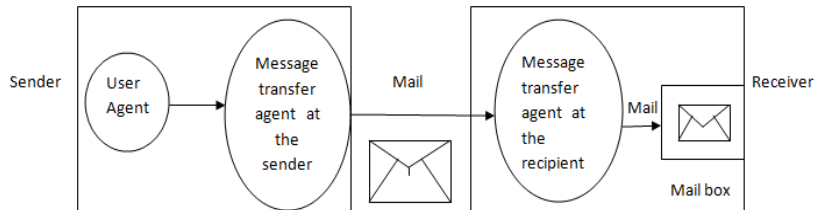

Figure 6.15: The e-mail process

i. **User Agent (UA):** The user agent provides user the facilities for composing and helps in sending mails, reading message, replying messages, storing the address of the recipient in the address book and retrieve those addresses while sending mails. It is also providing option for storing them in a particular folder or for forwarding, etc. The services provided by user agent make any user messages easier (sending or receiving). There are two types of user agent: GUI based and command driven agent.

GUI based: Now a days, GUI based user agents are used commonly. The GUI based user agent contains graphical based interface components. In this type, the user can interact with software by using mouse or keyboard. It contains some graphical icons, bar, menu which make the services easy to access. Some GUI based user agents are Microsoft's outlook, Netscape.

Command driven agent: In earlier days, command-based agents were used. Still, they are used as user agent in server side. In this type of agent, one character command from the keyboard is accepted to perform a particular task. Examples of this type are pine, elm and mail etc.

ii. **Mail transfer agent (MTA):** It is the second component of e-mail. It picks up the mail and delivers it to the other end user. It sets-up a TCP connection between the end user and prepares the mail. SMTP has set its rules how the sender proceeds after setting up a connection. Discussion on SMTP will be done later in this chapter.

Space for learners

- iii. The mail: The important component of email is the mail itself. The content may be simple text, an image, an audio, a video clip or may be an html page. The different content may also be in different format. For example an image file may be in “.jpeg” or “.png” or may be in “.gif”.

There are two types of user agent: command based or GUI based.

E-mail address:

For sending and receiving any e-mail, each user requires a unique email account. This is known as e-mail address. Generally, e-mail is known as a specific address in networking and it follows a particular rule for its addressing of the form username@domainname.

To create an e-mail address, following rules should be followed:

- The user name and the domain name are separated by “@” symbol.
- This address is not case sensitive.
- Spaces are not allowed.

Sending Mail:

Through the UA, a user can create mail that looks very similar to postal mail. It has different parts such an envelope and a message.

Envelope: The envelope usually contains the sender and the receiver addresses (TO and FROM).

Message:

The message contains two sections: the header and the body. The header has several sections which are:

- To: To whom the mail is sent.
- From: Who sent the mail.
- Subject: It indicates the purpose of the mail.
- Date: It indicates the date when the mail is sent.
- CC: CC for Carbon copy. It includes those recipient addresses whom we want to keep informed but not exactly the intended recipient.

Space for learners

- **BCC:** Bcc for **blind carbon copy** . It is used when we do not want one or more of the recipients to know that someone else was copied on the message.

Greeting:

Greeting is the opening of the actual message.

Signature:

This is the final part of an e-mail message. It includes Name of Sender, Address, and Contact Number.

The body of the message contains the actual information to be read by the recipient.

Space for learners

6.10.2 Simple Mail Transfer Protocol (SMTP)

In e-mail, actual mail transfer is done using Mail Transfer Agents (MTA). To send email, user needs a client MTA and to receive the sending mail, the server must have an MTA. SMTP is a standard protocol that defines the MTA client and server in the internet. SMTP defines how commands and responses are sent back and forth between the user. An architecture of SMTP is shown in figure 6.16.

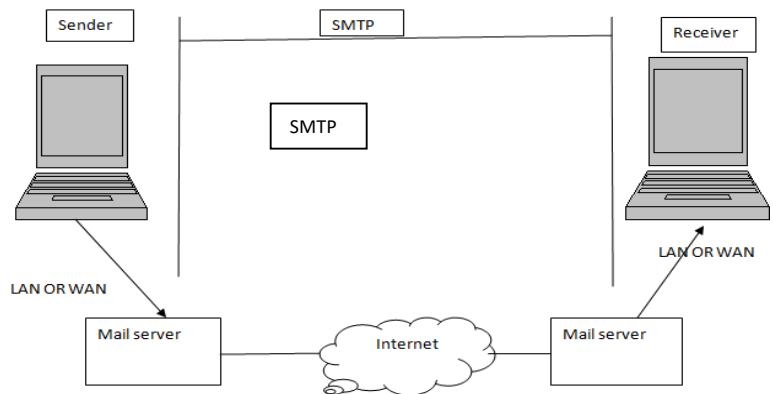

Figure 6.16: Architecture of SMTP protocol

In email, SMTP is used between the sender and the sender’s mail server and between the sender and receiver’s mail server. Another two protocols POP3 and ICMP are used to carry the mail to the receiver from the server. Different commands and responses are used in SMTP between an MTA client and an MTA server.

SMTP uses commands and responses to transfer messages between an MTA client and an MTA server.

In SMTP, Commands are sent from the client to the server. SMTP defines 14 different commands. Some of the commands are mandatory and remaining commands are often used. Some of the SMTP commands are given in Table 6.7 as follows:

Table 6.7: SMTP Commands

Keyword	Argument
HELO	Sender's host name
MAIL FROM	Sender of the message
DATA	Body of the sending mail
HELP	Command name

In SMTP, responses are from the server to the client. Responses are normally the three digit code followed by some textual information. Some of the responses are included in table 6.8

Table 6.8 SMTP responses

Three-digit code	Description
211	System help
250	Request command completed
354	Start mail input
421	Service not available
500	Syntax error
554	Transaction failed

Mail Transfer Phases

The mail transfer occurs in three phases: connection establishment, mail transfer, and connection termination.

6.10.3 POP and IMAP

Post Office Protocol, version 3 (POP3) and Internet Mail Access Protocol, version 4 (IMAP4) are the currently used as mail access protocol.

In the recipient computer, the client POP3 software is installed and the server POP3 software is installed on the mail server. The client

Space for learners

uses the TCP port 110 and mail access starts with the client when the user needs to download e-mail from the mailbox. When the client opens a connection with TCP, it then sends its user name and password to access the mailbox. From the mailbox, the client can then list out and retrieve the mailbox. In POP3, if the mail can be deleted from the mailbox after each retrieval, then it is known as delete mode and if the mail remains in the mailbox after retrieval also, it is known as keep mode. Thus, in POP3 two modes delete and keep modes are available.

IMAP (Internet Mail Access Protocol):

Internet Mail Access protocol version 4 is similar to POP3 which also can be used in e-mail as mail access protocol. But POP3 has some limitations and those limitations can be overcome by using IMAPv4 protocol. IMAPv4 is more complex and more powerful than POP3. IMAPv4 has additional functions over POP3. Some of them are listed below:

- ✓ Before downloading a user can check the mail header.
- ✓ On the mail server a user can create, delete or rename mail boxes.
- ✓ Prior to downloading a user can search the contents of the mail for a specific string of characters.

6.11 SUMMING UP

- The Simple Network Management Protocol (SNMP) is a framework for managing devices in an internet using the TCPI/IP protocol suite.
- The World Wide Web (W3) or the Web is an architectural framework for accessing linked content spread over millions of machines all over the Internet or it is the repository of information linked together from points all over the world.
- In 1990 Tim Berners Lee first ever introduced browser known as World Wide Web.
- URL, known as web address, is a unique identifier used to locate a resource on the internet composed of multiple parts. In 1994, URL was first introduced as a part of the Uniform Resource Identifier (URI).

- Web documents can be broadly classified into three categories: Static, Dynamic and Active.
- Hypertext Markup Language (HTML) is used to create web pages. HTML can describe the structure of the web pages. While developing a web page with HTML, it consists series of elements and these elements tell the web browser how to display the content of the web page.
- HTTP is an application layer protocol used basically to access data on the World Wide Web. HTTP is a request –response protocol. It uses the services of TCP. It provides an interface to the user to transfer resources in terms of request –response message using TCP protocol.
- In HTTP, it uses a three digit code which indicates the responses or status. The status code has five categories depending on their functionalities.
- A proxy is an application program or a computer system that behaves like an intermediary between the clients looking for services and servers.
- FTP is an application layer standard protocol for transferring files from a server to a client or from a host to another. During transfer of file from one system to another, there may be several issues say, two systems may use different ways to represent text and data or may use different file name conventions.
- Domain Name System (DNS) belongs to that category which is used as a supporting program that is used by another program.
- In application layer, there is a name management or name resolution for name resolution which is known as DNS.
- FTP is an application layer standard protocol for transferring files from a server to a client or from a host to another. FTP needs two connections: control connection and data connection.
- NFS enables system administrator to consolidate resources onto centralized servers on the network. In NFS, it uses Remote Procedure Calls (RPC) to route requests between the client and the server.

Space for learners

- RPC or Remote Procedure Call is used as a fundamental building block for implementing remote operations in a distributed system.
- Electronic mail or e-mail is one of the most popular Internet application programs.
- In an e-mail system, three basic components are included: user agent, message transfer and message access agent.
- SMTP is a standard protocol that defines the MTA client and server in the internet. SMTP defines how commands and responses are sent back and forth between the user.
- Post Office Protocol, version 3 (POP3) and Internet Mail Access Protocol, version 4 (IMAP4) are the currently used mail access protocol.
- IMAP v4 is more complex and more powerful than POP3.

Space for learners

6.12 ANSWERS TO CHECK YOUR PROGRES

1. False
2. A manager is a host that runs the SNMP client program. An agent is a router that runs the SNMP server program.
3. URL, which is known as web address, is a unique identifier used to locate a resource on the internet composed of multiple parts.
4. True.
5. The basic features of the web includes flexibility, portability and user friendly.
6. Cookies are alphanumeric values stored at the client by the browser
7. The content of static page cannot be changed by client; the client can get only a copy of the document. When the file is created, the contents are determined i.e. static documents are fixed-content documents that are created and stored in a web server.
8. False.
9. A markup language allows developer to embed formatting instructions in the file itself.
10. The head and the body.
11. True.

12. 80.
13. A proxy is an application program or a computer system that behaves like an intermediary between the clients looking for services and servers. HTTP protocol supports proxy server. It keeps copies of responses to recent requests.
14. org.
15. Partially Qualified Domain Name.
16. This protocol enables system administrator to consolidate resources onto centralized servers on the network.
17. NFSv2, NFSv3 and NFSv4.
18. 2049.

Space for learners

6.13 POSSIBLE QUESTIONS

Short type questions:

1. What do you mean by manager and agent in SNMP?
2. What is DNS?
3. Define WWW.
4. Mention name of different connections required in FTP?
5. What are the different pages used in HTML?
6. Write down the different components of e-mail.
7. Why NFS is used?
8. What is RPC?
9. What is SMTP?
10. What do you mean by MTA?
11. What is status code used in HTTP?
12. Why IMAP is used?
13. What do you mean by active document?

Long answer type questions:

1. Discuss the role of SNMP in network management.
2. Explain about the different connections of FTP with suitable diagram.
3. Explain how DNS works as address resolver?
4. Discuss the different types of pages uses in HTML.

5. Write a short note on NFS.
6. Explain about different protocols used in e-mail.
7. Why RPC is used? Explain in detail.
8. Discuss the need of FTP protocol.

6.14 REFERENCES AND SUGGESTED READINGS

- Bhushan Trivedi, Computer networks, Oxford higher education, 2019
- B.A Forouzan, Data communications and network, McGraw Hill higher education, 2018

Space for learners

UNIT 7: NETWORK MANAGEMENT AND SECURITY

Unit Structure:

- 7.1 Introduction
- 7.2 Unit Objectives
- 7.3 Network Management system
- 7.4 Simple Network Management Protocol (SNMP)
 - 7.4.1 Management components
- 7.5 Network Security
 - 7.5.1 Security services
 - 7.5.2 Message Privacy or Confidentiality
 - 7.5.3 Message Authentication
 - 7.5.4 Message Integrity
- 7.6 Entity Authentication
- 7.7 Summing Up
- 7.8 Answer to Check Your Progress
- 7.9 Possible Questions
- 7.10 References and Suggested Readings

7.1 INTRODUCTION

In this chapter, we shall discuss the basics of network management and the security. Moreover, the infrastructure for network management and security are also to be discussed. Networks and distributed processing systems are becoming critical and day by day growing importance in enterprises of all sorts. Hence, network management and security is considered one of the important topics of discussion. Network management is the process of administering and managing computer network or network management can be defined as overall monitoring of networks, testing, troubleshooting network components and configuring the network to meet a set of requirements defined by different organization. To perform network

Space for learners

management operation, a network management system uses a combination of software, hardware and human user. The most common protocol **Simple Network Management Protocol (SNMP)** used for the management and monitoring of network-connected devices is also stated here. Again, network security part is of equal importance in network; so, that part is also discussed here. In this context, the concepts of Cryptography, Firewall and Digital signature are introduced in this discussion.

Space for learners

7.2 UNIT OBJECTIVES

This unit basically includes basic concept of network management and security. Infrastructure for network management and security part is also included in this unit. After going through this unit, you will be able to:

- Learn the Key requirements that a network management system should satisfy.
- Understand an overview of the architecture of a network management system and explain each of its key elements.
- Learn the key protocol SNMP with different versions.
- State and explain the need of network security and the different services of network security.
- Explain basics of Cryptography.
- Understand Symmetric and asymmetric key cryptography.
- Explain basics of Digital signature.
- Learn about hash function.

7.3 NETWORK MANAGEMENT SYSTEM

It is already explained that network management is the combination of software, hardware and human user. The different functions performed by a network management system can be divided into different categories such as Security management, configuration management, fault management, Performance management and accounting management. Figure 7.1 depicts different functions of network management system.

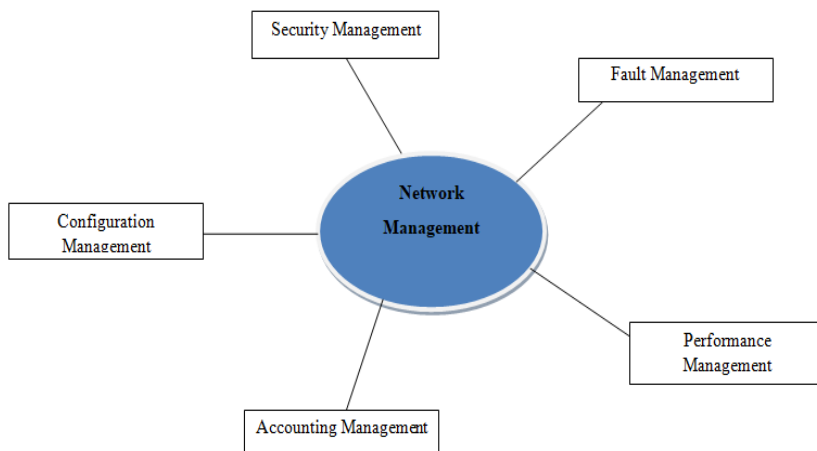

Fig 7.1: Different functions of Network Management system.

- **Security Management**

Security management is basically concerned with monitoring and controlling access to computer networks and access to all or part of the network management information obtained from the different network nodes. It is also concerned with generating, distributing and storing different encryption keys. User passwords and other authorization or control information are also maintained and distributed. Network resources and user information protection are done in security management. Logs are considered as one of the important security tools, so security management involves with the collection and storage of records. Again, network security facilities should be available for authorized users only in a network. It is responsible for controlling access to the network depending on the predefined security policy.

- **Configuration and Name Management**

As we know that networks are composed of hundreds of entities that are connected somehow either by physically or logically with each other. All these entities have a configuration at the initial stage when a network is set up but it may not be permanent. It needs to be changed with time. Some of the computers may have to be replaced by others. Sometimes the operating system may be updated to a newer version and the particular user may be moved from one network to another. So, at any time the configuration management must know the status of each entity in that network and relation of one entity with others. Depending on the type of function performed

Space for learners

in different parts of network, configuration management can be classified into two subsystems: reconfiguration and documentation.

Reconfiguration

Reconfiguration may be of several types such as hardware reconfiguration, software reconfiguration and user account reconfiguration. Any changes of hardware are considered under hardware reconfiguration, for example, a switch may need to be moved to another part of the network or may be one desktop is replaced by a laptop etc. All these need the time and attention of network management. Again, these types of reconfigurations cannot be automated and must be manually handled by some specialized person case by case. Software reconfiguration covers the functions of any changes to the software such as an operating system need to be updated for a newer version. But, most of the software reconfiguration can be automated. User account reconfiguration can be to some extent automated but human interaction is also required. User account reconfiguration covers adding and deleting of user, or other task such as a user may have some write and read permission with regard to some files or some permission for downloading a file etc.

Documentation

In network configuration, the original network configuration or any changes in the network must be recorded. In any kind of reconfiguration (i.e. in software, hardware or user account reconfiguration), documentation is required. In hardware documentation, two sets of documents involve: maps and specifications. Where maps tract each piece of hardware and its connection to the network, the specifications include types of hardware, its serial no. if any, time of purchase, warranty information etc. Similarly, all software also must be documented including different information about the software such as type of software, installed version and the time of installation etc. Using documentation, the network management must make sure that the files with this information are updated and secured.

- **Fault Management**

Fault management is an activity of network management that specially deals with any fault of the network components. A fault is usually indicated by failure to operate correctly or by excessive errors. An example of a fault is a damaged transmission medium.

Space for learners

This fault may interrupt communication or produce excessive errors. In the present scenario, networks are more complex and it made up of hundreds or thousands of components. Proper operation of this type of complex network depends on the proper operation of each and every component individually and in relation to each other. Fault management handles these types of issues. Reactive fault management and proactive fault management are two subsystems of fault management. Short term solutions of any fault (error) are handled by reactive management. It is basically responsible for detecting, isolating, correcting, and recording faults. The other subsystem of fault management is proactive fault management which tries to prevent faults from occurring. Some types of failures can be predicted and prevented before occur but this is not always possible.

- **Performance Management**

A performance management function includes monitoring and controlling. It is closely related to fault management which tries to quantify performance by observing capacity, traffic, throughput and response time.

Capacity

Performance management system monitors the capacity of the network. As we know that every network has a specific limited capacity, and the performance management system must ensure that it is not used above this capacity. As for example, a network is designed for 250 stations at an average speed of 900 Kbps, then it never operates properly for 500 stations.

Traffic

During a particular time, which can be considered as peak hours when all the systems are heavily used, blocking may occur if there is excessive traffic in that network. Traffic can be measured internally or externally. Inside the network if the number of packets is measured, it indicates as internal traffic. Again, if exchange of packets is measured outside the network it is known as external traffic.

Response Time

Performance management measures the response time. Response time is measured from that time when a user requests for a service

Space for learners

till the server grants it. Increased response time considers as a serious condition and it indicates traffic.

Throughput

Performance management monitors the throughput also and try not to reduce it beyond a limit.

- **Accounting Management**

Accounting management observes the users' access to network resources through charges. For any service from the network individual users, departments, divisions are charged. In accounting management, charging may not always mean cash; it may be debiting the departments or divisions for budgeting purposes. Different organizations use an accounting management system for different reasons such as to prevent users from using the system inefficiently and network managers can plan some short or long-term planning based on the demand for network use. In accounting management, reports should be generated under network manager control.

STOP TO CONSIDER

The Network Management System is the combination of software, hardware and human. The different functions performed by a network management system can be divided into different categories such as: security management, configuration and name management, fault management, Performance management and accounting management.

Security management, configuration and name management, fault management, Performance management and accounting management.

CHECK YOUR PROGRESS

Q1. What are the different types of reconfiguration management under Configuration and Name Management?

Q2. Inside the network if number of packets is measured, it indicates as internal traffic. (State TRUE/FALSE)

Space for learners

7.4 SIMPLE NETWORK MANAGEMENT PROTOCOL (SNMP)

The SNMP is a network management protocol using TCP/IP protocol suite. It is a framework for managing devices in an Internet and it provides a set of fundamental operations for monitoring and maintaining devices in Internet. The basic concept of SNMP with Managers and Agents are explained in chapter 6. In this chapter, we are discussing management components of SNMP, its role and versions of SNMP.

7.4.1 Management Components

SNMP uses two other protocols to do management task on the Internet which are: Structure of Management Information (SMI) and Management Information Base (MIB), as shown in Figure 7.2

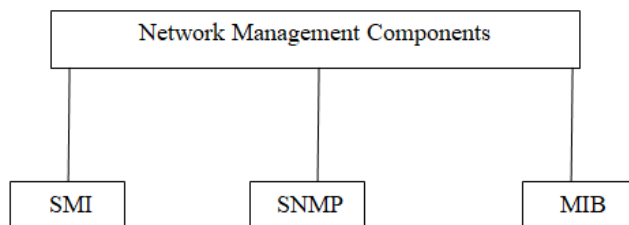

Figure 7.2: Network Management components

SMI

Structure of Management Information (SMI) is a collection of general rules to name object and to define type of data that can be stored in an object. It also shows how to encode data for transmission over the network. To handle an object, it emphasizes three attributes: name, encoding method and type. SMI follows a hierarchical structure for an object identifier. To name objects globally, an object identifier is used by SMI. SMI requires that each managed object has a unique name.

MIB

The Management Information Base, version 2 (MIBv2) is another component of network management. As stated earlier, SMI defines rules in network management i.e it sets rules to name object and defines type of data where in type it defines only the range and size

Space for learners

that can be stored in an object but MIB version 2 (MIBv2) names each object and also defines type of the object. In MIBv2, objects are categorized into different groups which are snmp, udp, tcp, system, address ip, icmp etc. All these groups are under mib2 object in the object identifier tree where each group has defined variables. Some examples of objects are:

- i. **snmp**: This object defines general information related to SNMP itself.
- ii. **tcp**: tcp object defines information related to TCP, such as number of packets sent and received, number of ports etc. “udp” object is also similar to tcp which defines information related to udp.
- iii. **sys**: sys object is related to system information such as name, location etc.

A management station performs the monitoring function by retrieving the value of MIB object.

SNMP

As stated earlier, the SNMP is the network management tool and it works on concept of managers and agent. In network management, SNMP takes helps of both SMI and MIB. SNMP allows a manager to retrieve the value of an object defined in an agent, it also allows a manager to store a value in an object defined in an agent. Moreover, it allows an agent to send an alarm message about an abnormal situation to the manager. SNMP has different versions with different features of each version. Normally, SNMP has three versions: SNMPv1, SNMPv2 and SNMPv3 which are presented in figure 7.3.

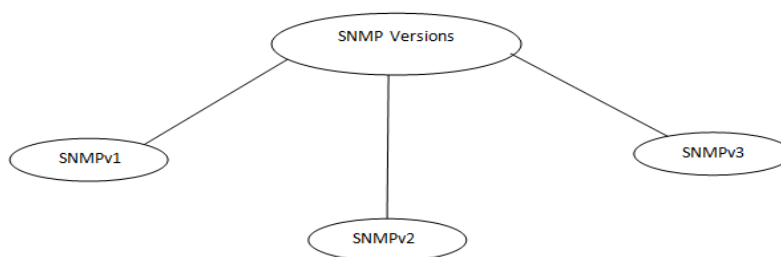

Figure 7.3: SNMP versions

SNMPv1

The original SNMP protocol is also called as SNMPv1. In 1980s, this protocol version was introduced and subsequently it became

widely used de facto network management protocol. In 1988, the first RFCs (Request for Comments) was appeared. RFC 1065, RFC 1066, RFC 1067 were used by SNMP. SNMP uses UDP connection again we know that UDP is a connectionless protocol so it itself connectionless. In SNMP, management requests are sent to UDP port 161 and the agent sends traps to UDP port 162. The manager and agent both implement SNMP, UDP and IP and the other relevant network dependent protocols. Three types of SNMP messages are issued on behalf of management applications which are: GetRequest, GetNextRequest and SetRequest. All messages are acknowledged by agent using Get Response message. The main issue with SNMPv1 is the security. SNMPv1 was designed with 32 bit counter means that it can count from 0 to 4.29 billion i.e. it cannot store maximum of a 10 gigabit or large interface. In SNMPv1, password can be read with packet sniffing.

SNMPv2

The enhanced version of SNMP is known as SNMPv2 with more security options. SNMPv2 allows password hashing with MD5. SNMPv2 was specially developed to provide data security.

SNMPv2 is the revised version of SNMP with enhanced protocol packet types, MIB structure elements but it uses the existing SNMPv1 administration structure. SNMPv2 uses RFCs 1901,1905 through 1909 and 2578 through 2580. In SNMPv2, it introduces an option for 64 bit data counters which can store from zero to 18.4 quintillion (approximately).

SNMPv3

With more security options SNMPv3 was introduced. SNMPv3 provides three important services which are: privacy, authentication and access control. Privacy and authentication are part of the User Based Security model (USM) and access control is defined in the View-Based Access Control Model (VACM). Moreover, SNMPv3 allows a manager to change the different security configuration remotely.

SNMP types of packets or PDUs are shown in Figure 7.4.

The different messages used in different versions of SNMP are:

- i. GetRequest: The GetRequest is sent from the manager (client) to the agent (server) to retrieve the value of a variable or a set of variables.

Space for learners

- ii. GetNextRequest: It is sent from the manager to the agent to retrieve the value of a variable.
- iii. GetBulkRequest: The GetBulkRequest is sent from the manager to the agent to retrieve a large amount of data. It is the replacement of multiple GetRequest and GetNextRequest.
- iv. SetRequest: The SetRequest is sent from the manager to the agent to set a value in a variable.
- v. Response: The Response is sent from an agent to a manager in response to GetRequest or GetNextRequest.
- vi. Trap: The Trap is sent to the manager from the agent to report an event.

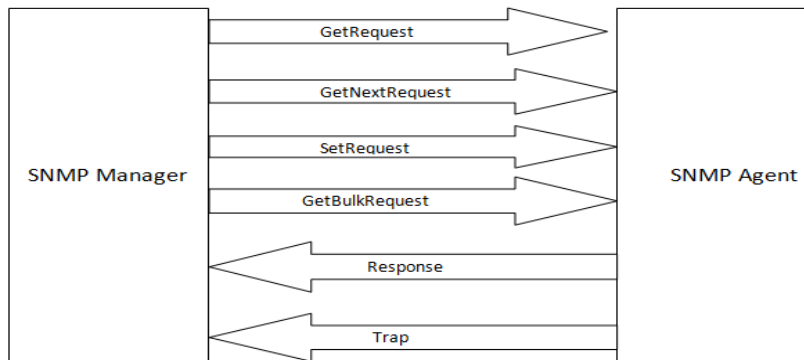

Figure 7.4: SNMP different data packets or PDUs

STOP TO CONSIDER

In network management, SNMP takes help of both SMI and MIB. SMI is a collection of general rules to name object and to define type of data that can be stored in an object. It also shows how to encode data for transmission over the network. MIB version 2(MIB 2) names each object and also define type of the object. SNMP has three versions SNMPv1, SNMPv2 and SNMPv3.

Space for learners

CHECK YOUR PROGRESS

Q3. The Trap is sent to the agent from the manager to report an event. (State TRUE/FALSE)

Q4. SNMPv1 contains -----bit counter.

Q5. What are the different services provided by SNMPv3?

Space for learners

7.5 NETWORK SECURITY

Network security is one of the major challenges in networking. The network may be attacked by several threats but we have to protect our data somehow, so in this chapter we will introduce security services that we typically expect in a network. Then, we discuss how cryptography can be used in network security and also discuss about the concept of symmetric and asymmetric keys. Digital signature will also be discussed here.

7.5.1 Security services

Network security can address different services related to the message and the entity. Some of the message related services are: privacy or confidentiality, authentication, integrity and availability. Again, service related to entity is entity authentication or identification. Various Messages and entity related security services are presented in Figure 7.5.

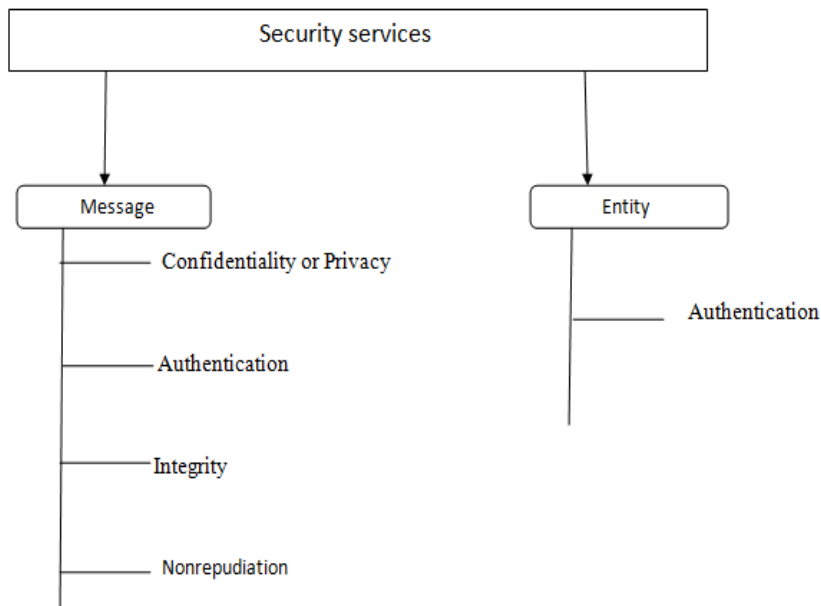

Figure 7.5: Message and entity related security services

Message:

Confidentiality or Privacy

In a network, a user expects privacy or confidentiality. When a sender sends a message, it sends it to a particular or intended receiver. For example, when a customer communicates online with a medical consultant or with online banking, the user expects that the communication between the two parties must be confidential.

Authentication

While a receiver receives a particular information, the receiver needs to be sure that about the sender's identity otherwise in some situations it may be a critical issue.

Integrity

Message integrity describes the concept of ensuring that data has not been modified in transit it requires that only authorized parties can modify data. Message modification includes writing, deleting, changing status etc.

Nonrepudiation

Generally, nonrepudiation combines both authentication and integrity. It provides proof of the originality, authenticity and

Space for learners

integrity of the sending data. It helps in sender's identity and later on neither site can deny that a message was sent ,received.

Entity

Authentication

The entity authentication or user authentication is done before access of the web resources. The entity authentication is one way to protect the resources and the user.

7.5.2 Message Privacy or Confidentiality

In message confidentiality, the message must be secured somehow so that the message is being unintelligible to any of the unauthorized parties.

In that case, some privacy techniques are used and these techniques guarantee to some extent. The concept of cryptography is used where messages are encrypted at the sender site and decrypted at the receiver site.

Cryptography

Network security is mostly achieved through the use of cryptography which means secret writing. In computer science, cryptography refers to secure information and communication techniques derived from mathematical concepts and a set of rule-based calculations called algorithms. While explaining Cryptography, several terms are used such as plaintext, cipher text, key. These are considered as components of cryptography. During cryptography, in sender site the sending message is encrypted and in receiver site the message is decrypted. Figure 7.6 shows the components of cryptography:

Space for learners

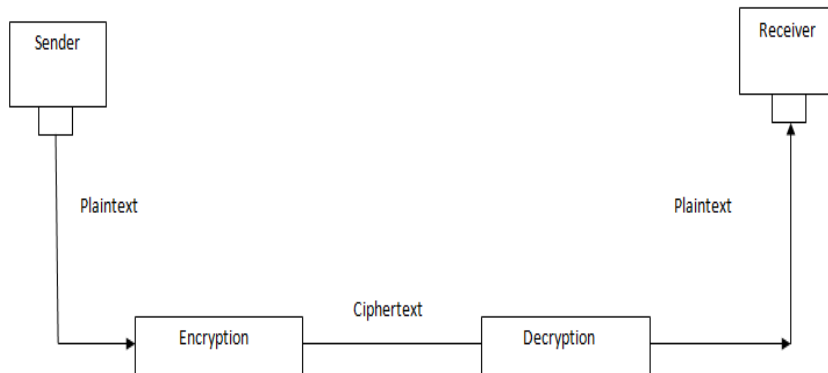

Figure 7.6: Components of cryptography

Now we are going to discuss about the different terms used in figure 7.6.

Plaintext

The original message before being transformed or encrypted is known as plaintext. Encryption algorithms are used to transform a plaintext to ciphertext in sender site.

Ciphertext

When message (plaintext) is transformed using encryption algorithm, it is known as ciphertext. In receiver site some decryption algorithms are used to transform ciphertext back into plaintext.

Cipher

Whatever encryption and decryption algorithms are used known as ciphers.

Key

Key is nothing but a number or a set of numbers that the cipher, as an algorithm operates on. For encryption, an encryption key and plaintext are required which gives us ciphertext. Similarly, in decryption technique (from ciphertext to plaintext), a decryption algorithm, a decryption key and the transformed ciphertext are employed which gives a receiver the original message(plaintext).

The categories of cryptography algorithms (cipher):

Cryptography algorithms are divided into two groups:

- Symmetric key cryptography algorithms

Space for learners

➤ Asymmetric key cryptography algorithms.

Space for learners

Symmetric key cryptography algorithms

The basic concept of symmetric key is that in symmetric key both parties use the same key. In sender site, the sender uses this key for encrypt data with an encryption algorithm and in receiver site, the receiver uses the same key to decrypt the encrypted data with a decryption algorithm. A schematic diagram of Symmetric key cryptography is presented in figure 7.7.

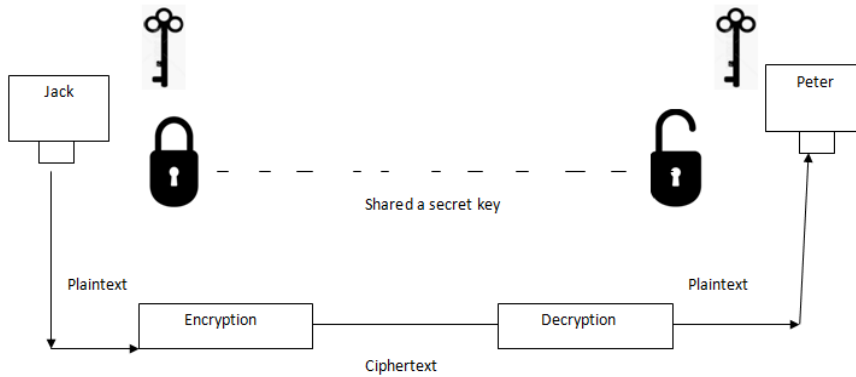

Figure 7.7: Symmetric key cryptography where a shared key can be used in Jack-Peter communication

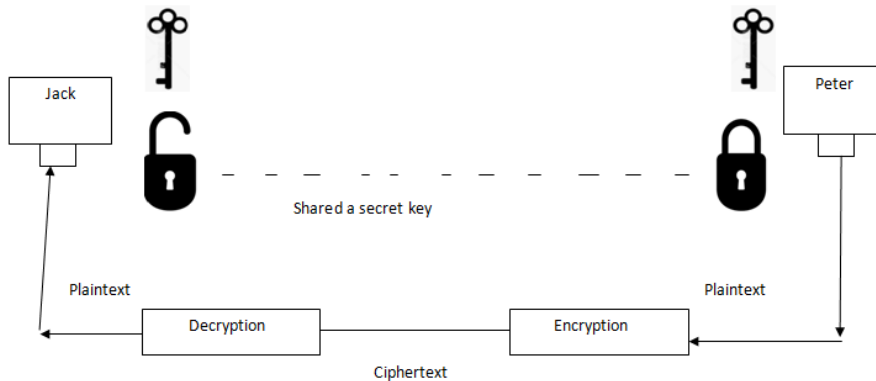

Figure 7.8: A different key is recommended in Peter –Jack communication

As shown in the above figure 7.7 and figure 7.8, to provide confidentiality or privacy with symmetric-key cryptography, a sender and a receiver need to share a secret key. The symmetric key allows the communication in both direction although it is not recommended. In communication, two key concepts are most

popular. As if one key is compromised, the communication is still confidential in the other direction. So, symmetric key is still the dominant method for message confidentiality. But for long message, symmetric key cryptography is considered to be more efficient.

Ciphers are more complex used in symmetric key. Now, we are going to discuss traditional ciphers., which are character oriented. Some ciphers are bit oriented also.

Traditional Ciphers

Though the traditional ciphers are obsolete now but we try to show how modern ciphers are evolved from those ciphers. Traditional symmetric key ciphers are of two categories:

- Substitution ciphers and
- Transposition ciphers.

Substitution cipher

As the name suggest, a substitution cipher substitutes one symbol with another symbol. Depending on the plaintext, substitution are used say if plaintext are some alphabetic characters then one alphabetic character is replaced with another; again, if it is numbers then it replaced by numbers in ciphertext. For example, alphabetic character B is replaced with H and character F with U. And, in numbers 1 is replaced with 8 or 4 with 9 etc. Substitution ciphers have two categories: monoalphabetic and polyalphabetic ciphers.

In a monoalphabetic cipher, a symbol (alphabet or number) in the plaintext is changed to the same symbol which means that if that algorithm says that X is replaced with B then every character X is replaced with B regardless of the position. Plaintext and ciphertext relationship are one to one.

But in polyalphabetic cipher, it is not like that. Here, each occurrence of a character in plaintext can have different substitutes in ciphertext i.e. it follows one –to- many relationship.

Example 1. The following example shows a plaintext and its corresponding ciphertext. Is the cipher monoalphabetic?

Plaintext: SORRY Ciphertext: APXXR

Solution: The cipher is probably monoalphabetic because both occurrences of R's are encrypted as X's.

Example 2

The following shows a plaintext and its corresponding ciphertext. Is the cipher monoalphabetic?

Plaintext: SORRY Ciphertext: ZATCG

Solution: As in ciphertext, each occurrence of R is encrypted by a different character so it is not monoalphabetic rather it is polyalphabetic.

Transposition ciphers.

In this cipher, locations are changed instead of substitutions. A symbol in the plaintext may be in the first position but in ciphertext it may be in 7th position i.e it reorders the symbol in a block of symbols. For example:

Plaintext: 4567

Ciphertext: 7654

So, in this example we change the position of the symbols. In decryption, we have arranged them only in reverse order.

➤ Asymmetric Key Cryptography

In asymmetric key cryptography, two keys are used instead of one as in symmetric key. Here a private key and a public key are used. The sender uses the public key to encrypt the message and the receiver uses a private key to decrypt the encrypted message. The public key is available to the public but the private key is available only to an individual.

For a two-way communication between Jack and Peter, two pairs of keys are needed. When Jack sends a message to Peter, Jack uses Peter's pair again when Peter sends a message to Jack, he uses Jack's pair as shown in figure 7.9 and 7.10 respectively.

Space for learners

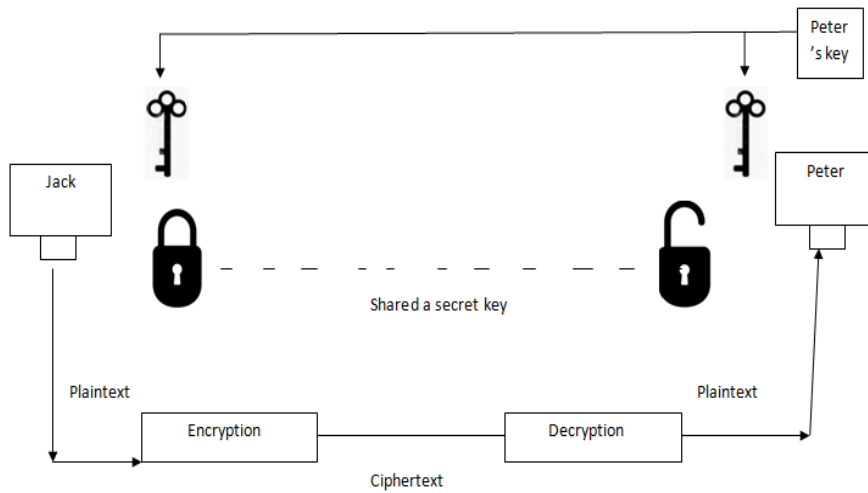

Figure 7.9: Peter's keys are used in Jack-Peter communication

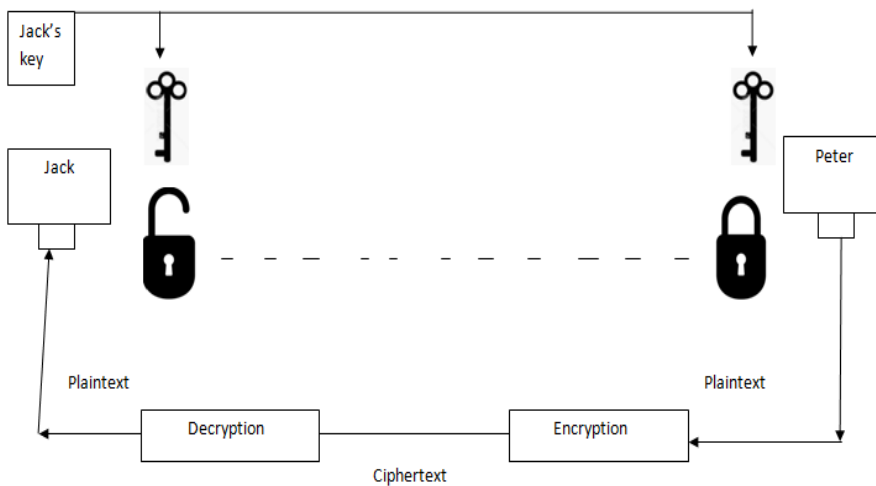

Figure 7.10: Jack's keys are used in Peter-Jack communication

Asymmetric key is applied only to short messages i.e this system is inefficient for long messages.

The most common public key algorithm used in asymmetric key algorithm is RSA, named after its inventors Rivest, Shamir, and Adleman (RSA).

STOP TO CONSIDER

Network security is mostly achieved through the use of cryptography which means secret writing.

Symmetric and asymmetric key cryptography are the two categories of cryptography.

In symmetric key cryptography, single key is shared between the sender and receiver which is known as secret key. But in asymmetric key cryptography, two keys are used: Public and private key.

Space for learners

CHECK YOUR PROGRESS

Q6. Message after encryption is known as-----
-----.

Q7. What do you mean by cipher?

Q8. What are the different categories of traditional ciphers?

7.5.3 Message Authentication

In communication, message authentication is one of the important factors as the receiver must have to confirm about the sender identity proof. The digest created by a hash function is called modification detection code (MDC); this can be used to detect any modification in the messages. Hash function will shortly be discussed in message integrity section.

For message authentication, a message authentication code (MAC) is required where it uses a keyed hash function. A keyed hash function includes the symmetric key between both parties i.e. between the sender and the receiver when creating the digest.

Digital signature

As mentioned above, MAC can provide message authentication. In this code, it needs a symmetric key that must be established between both parties which is considered as a disadvantage of MAC. So, digital signature is introduced where it uses asymmetric keys i.e. public and private keys. An electronic signature can prove the authenticity of the sender of a message and this type of signature is

called digital signature. As we know that in a traditional manual manner a person signs a document to show that it is originated from him/her or approved by him/her. Here, the signature is the proof to the recipient that the document comes from the correct sender. Similar approach is applied in digital document also. The concept of digital signature is depicted in figure 7.11.

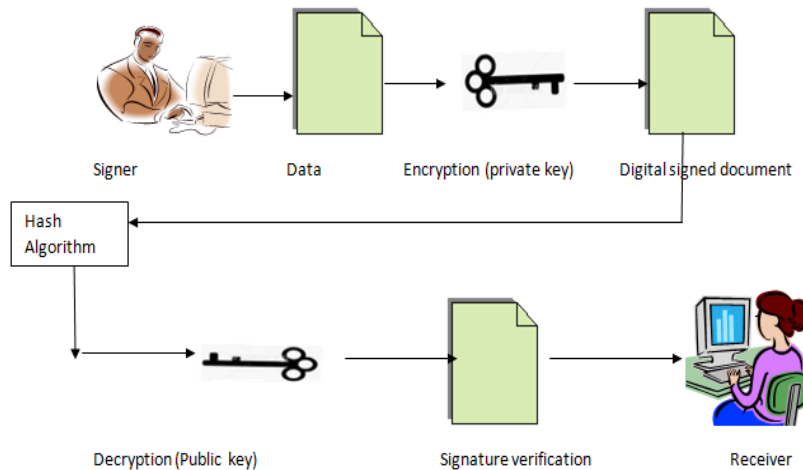

Fig 7.11: Digital signature

Digital signature has been performed in two ways: signing the document or signing a digest of the document. Signing the document is probably the easier but sometimes it may be considered as less efficient. Signing means document is encrypted with a private key of the sender and verifying the signed document is decrypted with the public key of the sender as shown in figure 7.11. In digital signature, the sender uses its own private key and the receiver uses public key of the sender.

In digital signature, normally message is long but it has to use public keys, so not to sign the document itself instead sign a digest of the message. The sender can sign the digest and receiver can verify the digest.

A digital signature provides three services in security: integrity, authentication and message nonrepudiation.

STOP TO CONSIDER

In digital signature use asymmetric keys i.e public and private keys.

A digital signature provides three services in security. A digital signature provides integrity, authentication and message nonrepudiation

Space for learners

7.5.4 Message Integrity

As already mentioned above that, message integrity explains whatever the original document should not be tempered by other user i.e., we have to ensure that original document remains unchanged over the years. The message needs to be safe from any tempering by some unauthorized users.

To preserve the integrity of the original message, the message passed through an algorithm which is known as hash function where the hash function creates a compressed image of the original message that can be used as a fingerprint as it must be compared on required situation.

7.6 ENTITY AUTHENTICATION

An entity can be a person, a client, a server or a process. In entity authentication, a technique is designed to let one party proof the original identity of another party. Here, we have two parties: claimant and the verifier. The party whose identity need to be proved is called the claimant and the other party that tries to prove the identity of the claimant is called the verifier.

There are some differences between message authentication and entity authentication. Message authentication simply authenticates one message and the same process needs to be repeat again for each new message but in entity authentication, it authenticates the claimant for the entire duration of a particular session. Again, message authentication may not be in real time but entity authentication is in real time etc.

There are three kinds of witnesses which can be used in entity authentication such as: something known, processed or inherent. If we see something known then this is a secret one and only used by the claimant that can be used for verification by the verifier such as password, a secret key or may be the PIN number. In case of something processed, this is something which can be used to prove the identity such as passport, license of a driver, credit card or smart card of a person. If we look something inherent, it represents an inherent characteristic of the claimant such as retinal pattern, fingerprints, voice, handwriting or facial appearance etc.

Password

The general and oldest method of entity authentication where a password is used when a particular user needs to access a system to use system's resources, the password is private. In password authentication, we have two categories:

- Fixed password and
- One time password

In Fixed password approach, the same password is used again and again for every access of the system or services by the user. But in this approach, there are some possibilities of attacks such as guessing a password, stealing a password or accessing a file. A more secure approach is that instead of the plaintext password, the hash of the password should be stored in the password file. In that case, other user can read the contents of the file but as it is stored using hash which is a one-way function, it is almost impossible to guess exact value of the password.

As name indicates One-Time Password is used only once. So in this case, password stealing, guessing are not fruitful. However, this approach is very complex and not discussed in this chapter.

Challenge-Response

From the above discussion, we can see that password can be used for entity authentication but it also has some issues. So, another approach which is known as challenge –response is introduced. In challenge-response authentication approach, the claimant proves that the user knows a secret without revealing it. Here, the claimant does not reveal the secret to the verifier; the verifier either has it or finds it. Here challenge is a time-varying value and sent by the verifier. The claimant applies a function to the challenge and sends

the result to the verifier called a response. In response, it shows that the claimant knows the secret.

Challenge-response authentication is possible with the use of the several approaches such as using a Symmetric-Key Cipher, using Keyed-Hash Functions, using an Asymmetric-Key Cipher and using Digital Signature.

STOP TO CONSIDER

Password is the most common approach of entity authentication. Fixed password approach has some issues. One time password is more secure than fixed one. Moreover, password challenge-response approach is also used in entity authentication.

CHECK YOUR PROGRESS

Q9. What are the two categories of password?

Q10. In entity authentication, message is also authenticated.
(State TRUE/FALSE)

7.7 SUMMING UP

- Security management is basically concerned with monitoring and controlling access to computer networks and access to all or part of the network management information obtained from the different network nodes.
- In network configuration, the original network configuration or any changes in the network must be recorded. In any kind of reconfiguration, documentation is required.
- SMI, SNMP and MIB- these are considered three network management components.
- The Simple Network Management Protocol (SNMP) is a framework for managing devices in an internet using the TCP/IP protocol suite which uses UDP Port 161 and 162.
- SNMP has three versions: SNMPv1, SNMPv2 and SNMPv3.

Space for learners

- SNMPv3 has several additional features over SNMPv2 such as privacy, authentication and access control.
- Network security can address different services related to the message and the entity. Message related services are: privacy or confidentiality, authentication, integrity and availability. Service related to entity is entity authentication or identification.
- In message privacy cryptography is used. Network security mostly achieved through the use of cryptography which means secret writing.
- Two common categories of cryptography are Symmetric key cryptography and Asymmetric key cryptography.
- Digital signature uses asymmetric key cryptography. A digital signature provides integrity, authentication and message nonrepudiation.
- A entity can be a person, a client, a server or a process. In entity authentication, a technique is designed to let one party proof the original identity of another party. Here, we have claimant and the verifier.
- Password is the general and old method of entity authentication.

Space for learners

7.8 ANSWERS TO CHECK YOUR PROGRES

1. hardware reconfiguration, software reconfiguration and user account reconfiguration.
2. TRUE.
3. FALSE
4. 32
5. Privacy, authentication and access control.
6. Ciphertext.
7. Whatever encryption and decryption algorithms are used known as ciphers.
8. Substitution ciphers and Transposition ciphers
9. Fixed password and one time password.
10. False

7.9 POSSIBLE QUESTIONS

Short answer type questions:

1. What do you mean by network management?
2. Mention different versions of SNMP.
3. Mention services provided by SNMP.
4. Why network security is required.
5. What do you mean by message integrity?
6. Define key.
7. What is transposition cipher?
8. Why digital signature technique is required?
9. What do you mean by entity authentication?
10. What are the different approaches used in challenge response authentication technique?

Long answer type questions:

1. Discuss the role of SNMP in network management.
2. What are the different security services? Explain in details.
3. Discuss asymmetric-key cryptography.
4. Explain the digital signature method.
5. Discuss how entity authentication is done and why it is important.

7.10 REFERENCES AND SUGGESTED READINGS

- Bhushan Trivedi, Computer networks, Oxford higher education,2019
- B.A Forouzan, Data communications and network McGraw Hill higher education,2016

Space for learners